

Katalog 2013

Płytki wieloostrzowe i narzędzia składane do toczenia i frezowania
Indexable inserts and tools for turning and milling





Indeks płytek i narzędzi do toczenia
Index of inserts and tools for turning



Płytki do toczenia:
Inserts for turning:

	Strona/Page
CCGT	C16
CCMT	C13
CNMA	C5
CNMG	C4-5
CNMM	C5
DCGT	C16
DCMT	C13
DNMG	C6
ECMT	C13
KNUX	C19
LNUX	C20
RCMT	C14
RCMX	C14
RNMG	C6
SCGT	C16
SCMT	C14
SNGN	C17
SNMA	C7-8
SNMG	C7-8
SNMM	C7-8
SNUN	C17
SPGN	C17
SPMR	C19
SPUN	C17
TCGT	C16
TCMT	C15
TNGN	C18
TNMA	C9-10
TNMG	C10-10
TNMM	C9-10
TNMR	C20
TNMX	C21
TNUN	C18
TPGN	C18
TPMR	C19
TPUN	C18
VBMT	C15
VBMW	C15
VCGT	C16
VNMG	C11
WCMT	C15
WNMA	C12
WNMG	C12
XNMX	C21

Płytki podporowe i łamacze wióra:
Shims and chip-breakers:

	Strona/Page
111.24-721	C27
111.26-622	C27
111.26-628	C27
111.26-629	C27
117.26-621	C26
117.26-622	C26
117.26-719	C26
123.22-621	C27
123.24-721	C26
123.26-622	C26
123.26-628	C26
170.26-624	C26
170.36-624	C27
171.64-721	C26
171.66-624	C26
172.00-721	C27
174.10-621	C29
174.10-622	C29
174.10-628	C29
174.10-629	C29
174.11-621	C29
174.11-628	C29
174.11-629	C29
175.10-621	C28
175.10-622	C28
175.10-624	C28
175.10-629	C28
175.11-621	C28
175.11-624	C28
175.11-629	C28
176.00-854	C27
454.64-721	C26
PK..	C29
PT..	C28
PTF	C21
R166.10	C21

Płytki do przecinania i rowkowania:
Inserts for parting and grooving:

	Strona/Page
LFMX	C22
X61	C23
X92	C24-25

Narzędzia do toczenia – zewnętrzne:
Tools for turning – external:

	Strona/Page
MSSNR/L	D 4
MTENN	D 4
MTGNR/L	D 4
MTJNR/L	D 4
MWLNRL	D 5
N 176.39	D 9
PCBNR/L	D 6
PCLNR/L	D 6
PDJNR/L	D 6
PRGCR/L	D 9
PRGNR/L	D 9
PSBNR/L	D 7
PSDNN	D 7
PSKNR/L	D 7
PSSNR/L	D 7
PTDNR/L	D 8
PTFNR/L	D 8
PTGNR/L	D 8
PTTNR/L	D 8
R/L 171.35	D 6
SCLCR/L	D 10
SDJCR/L	D 10
SRDCN	D 11
SRDCR/L	D 11
SRSCR/L	D 11
SSBCR/L	D 12
SSDCN	D 12
SSDCR/L	D 12
SSKCR/L	D 12
STDCR/L	D 13
STFCR/L	D 13
STFCR/L...-A	D 13
STGCR/L	D 14
STJCR	D 14
STTCR/L	D 14
SVHBR/L	D 15
SVJBR/L	D 15
SVVBN	D 15

Narzędzia do toczenia – wewnętrzne:
Tools for turning – internal:

	Strona/Page
A..-MWLNRL	D 16
A..-SCLCR/L	D 19
A..-SDUCR/L	D 20
A..-SSKCR/L	D 20
A..-STFCR/L	D 21
A..-SVQBR/L	D 21
A..-SVUBR/L	D 21
S..-CKUNR/L	D 19
S..-MVUNR/L	D 16
S..-PCLNR/L	D 17
S..-PDUNR/L	D 17
S..-PSKNR/L	D 18
S..-PTFNR/L	D 18
S..-SCLCR/L	D 19

Narzędzie do przecinania i rowkowania:
Tools for parting and grooving:

	Strona/Page
C92-LC	D26
C92-LD	D27
C92-RC	D26
C92-RD	D27
P61.SFR/L	D23
P61.SGR/L	D23
P92.CGR/L	D25
P92.CXCBL/L	D24
P92-2-CXCCLC	D26
P92-2-CXCRC	D26
P92-2-CXCCLD	D27
P92-2-CXCARD	D27
P92-90-CXCCLD	D27
P92-90-CXCARD	D27
P92-S-CXCBL/L	D24
SBN	D22
XLFCN	D22

TRADYCJA I STABILNOŚĆ

BAILDONIT jest najstarszą i najbardziej stabilną marką na rynku polskim (r.1936) związaną z obróbką skrawaniem. Naszą specjalizacją są produkty wytwarzane z węglików spiekanych: płytki wieloostrzowe oraz narzędzia do obróbki skrawaniem.

MIĘDZYNARODOWE DOŚWIADCZENIE I ROZWÓJ

Od 1998 roku należymy do szwedzkiego koncernu Sandvik AB, który od pół wieku utrzymuje pozycję światowego lidera w świecie obróbki skrawaniem. Sandvik AB to doświadczenie oraz dynamiczny rozwój a ścisła współpraca wewnątrz koncernu pozwala na systematyczne unowocześnianie i dostosowywanie naszej oferty do potrzeb naszych klientów. Wyroby BAILDONIT produkowane są w zgodzie ze standardami Zintegrowanego Systemu Jakości i Zarządzania Środowiskowego ISO 9001 i ISO 14001.

NASZ CEL

Naszym głównym celem jest sprzedaż produktów i usług w taki sposób, aby klienci posługujący się płytkami i narzędziami skrawającymi Baildonit w obróbce metali mogli podnosić swoją produktywność a współpraca z nami była prosta i skuteczna.



TRADITION AND BRAND AWARENESS

BAILDONIT is the oldest (1936) and the best-established brand in the Polish market in the metal working field. Our company specialises in sintered carbide products: indexable inserts and toolholders.

INTERNATIONAL EXPERIENCE AND DEVELOPMENT

Since 1998 the company has belonged to a Swedish group of Sandvik AB, which has been a global market leader in metal working for years. Sandvik AB stands for experience and a dynamic development, and close co-operation inside the group allows us to modernise and tailor our offer to our customers' needs on a regular basis. BAILDONIT products comply with the standards of the Integrated Quality and Environmental Management System of ISO 9001 and ISO 14001.

OUR OBJECTIVE

Our key objective is to sell products and services in such a way as to enable customers using our inserts and tools to improve productivity and ensure simple and effective co-operation with our company.

str. / page: rozdział / chapter:

A **INDEKS / INDEX:**

- A2 Indeks płytek i narzędzi do toczenia
Index of inserts and tools for turning
- A3 Indeks płytek i narzędzi do frezowania
Index of inserts and tools for milling

B **WĘGLIKI SPIEKANE / SINTERED CARBIDES:**

- B2 Informacje ogólne
General information
- B5 Gatunki węglików spiekanych do toczenia
Grades of sintered carbides for turning
- B8 Tabela zbiorcza gatunków do toczenia
The summary table of grades for turning
- B11 Gatunki węglików spiekanych do frezowania
Grades of sintered carbides for milling
- B14 Tabela zbiorcza gatunków do frezowania
The summary table of grades for milling

C **PŁYTKI DO TOCZENIA / INSERTS FOR TURNING:**

- C2 Oznaczenie płytek do toczenia
Designation of inserts for turning
- C4 Płytki do toczenia
Inserts for turning
- C22 Płytki do przecinania
Inserts for parting
- C23 Płytki do rowkowania X61..
Inserts for grooving X61..
- C24 Płytki do rowkowania z roztaczaniem X92..
Inserts for grooving and recessing X92..
- C26 Płytki podporowe i łamacze wióra
Shims and chipbreakers

D **NARZĘDZIA DO TOCZENIA / TOOLS FOR TURNING:**

- D2 Przecinaki listwowe XLCFN..
Parting blades XLCFN..
- D3 Noże do rowkowania P61..
Toolholders for grooving P61..
- D4 Noże do rowkowania z roztaczaniem P92..
Toolholders for grooving and recessing P92..

str. / page: rozdział / chapter:

E **PŁYTKI DO FREZOWANIA / INSERTS FOR MILLING:**

- E2 Oznaczenie płytek do frezowania
Designation of inserts for milling
- E4 Płytki do frezowania
Inserts for milling
- E10 Płytki do frezowania – narzędzia QUADRI i ECO 45
Inserts for milling – QUADRI and ECO 45 tools
- E12 Płytki do frezów tarczowych
Inserts for slitting cutters
- E13 Płytki do wiercenia
Inserts for drilling
- E14 Płytki podporowe
Shims

F **NARZĘDZIA DO FREZOWANIA / TOOLS FOR MILLING:**

- F2 Głowice frezowe ECO 45
ECO 45 milling cutters
- F3 Frezy trzpieniowe ECO 45
ECO 45 shank cutters
- F4 Frezy tarczowe NFTs..
NFTs.. slitting cutters

G **INFORMACJE TECHNICZNE / TECHNICAL INFORMATION:**

- G2 Zastosowanie narzędzi do toczenia
Application of tools for turning
- G16 Zastosowanie narzędzi do przecinania
Application of tools for parting
- G17 Zastosowanie narzędzi do rowkowania P61..
Application of tools for grooving P61..
- G18 Zastosowanie narzędzi do rowkowania z roztaczaniem P92..
Application of tools for grooving and recessing P92..
- G20 Zastosowanie narzędzi do frezowania
Application of tools for milling
- G26 Zastosowanie płytek do frezowania w narzędziach innych producentów
Application of inserts for milling in other producers' tools
- G32 Zastosowanie narzędzi QUADRI i ECO 45
Application of QUADRI and ECO 45 tools
- G46 Zastosowanie narzędzi SR.. do frezowania form i matryc
Application of SR.. ball nose milling cutters
- G52 Zastosowanie frezów tarczowych NFTs..
Application of NFTs.. slitting cutters
- G54 Zestawienie materiałów obrabianych
Materials coparison
- G56 Rodzaje zużycia ostrza
Tooth wear

CERTYFIKAT



ISO 9001:2008

DEKRA Certification Sp. z o.o. niniejszym potwierdza, że przedsiębiorstwo

SANDVIK POLSKA Sp. z o.o.

wdrożyło system zarządzania jakością zgodnie z ww. normą i skutecznie go realizuje.
Zgodność systemu została udokumentowana w raporcie numer W-A 334613/A11/U/9001.

zakres certyfikacji:

Usługi handlowe w zakresie importu, eksportu i pełnej logistyki – łącznie z dokumentacją handlowo-finansową, oraz doradztwo techniczne w zakresie optymalnego stosowania narzędzi skrawających Coromant i Baidonit, stali specjalnych Sandvik SMT oraz wszystkich innych artykułów wytwarzanych w jednostkach produkcyjnych koncernu Sandvik AB.

certyfikowana siedziba:

Al. Wilanowska 372 ▪ PL – 02-665 Warszawa

Certyfikat ważny od 2013-04-25 do 2016-04-24

Nr rejestracyjny certyfikatu: 100501097/4
Duplikat



DEKRA Certification Sp. z o.o.
Wrocław, 2013-04-24

Deutsche
Akkreditierungsstelle
D-ZM-16029-01-01

str. / page: rozdział / chapter:

- A2 Indeks płytek i narzędzi do toczenia
Index of inserts and tools for turning
- A3 Indeks płytek i narzędzi do frezowania
Index of inserts and tools for milling

Indeks płytek i narzędzi do frezowania
 Index of inserts and tools for milling

Płytki do frezowania:
Inserts for milling:

	Strona/Page
ADMT	E8
ADMW	E8
APFT	E8
APKW	E8
CCMX	E8
LFMX	E12
LPKN	E5
ODKT	E10
ODMT	E10
RDGT	E10
RDMT	E10
RPHT	E8
SDKT	E11
SDMT	E11
SEAN	E4
SEGN	E4
SEHX	E9
SEKN	E4
SEKR	E4
SNHN	E4
SNKN	E4
SPAN	E5
SPKN	E5
SPKR	E5
SPMT	E9
SPMW	E9
SPMX	E9
TCMT	E9
TEGN	E7
TPAN	E6
TPKN	E6-7
TPKR	E6
WCMX	E13

Płytki podporowe:
Shims:

	Strona/Page
175.11-624	E15
220.13-621-12	E15
220.13-624-15	E15

Narzędzia do frezowania:
Tools for milling:

	Strona/Page
GQ..	F2
GQ..CM..	F3
NFTs..	F4





WĘGLIKI SPIEKANE

SINTERED CARBIDES

B

str. / page: rozdział / chapter:

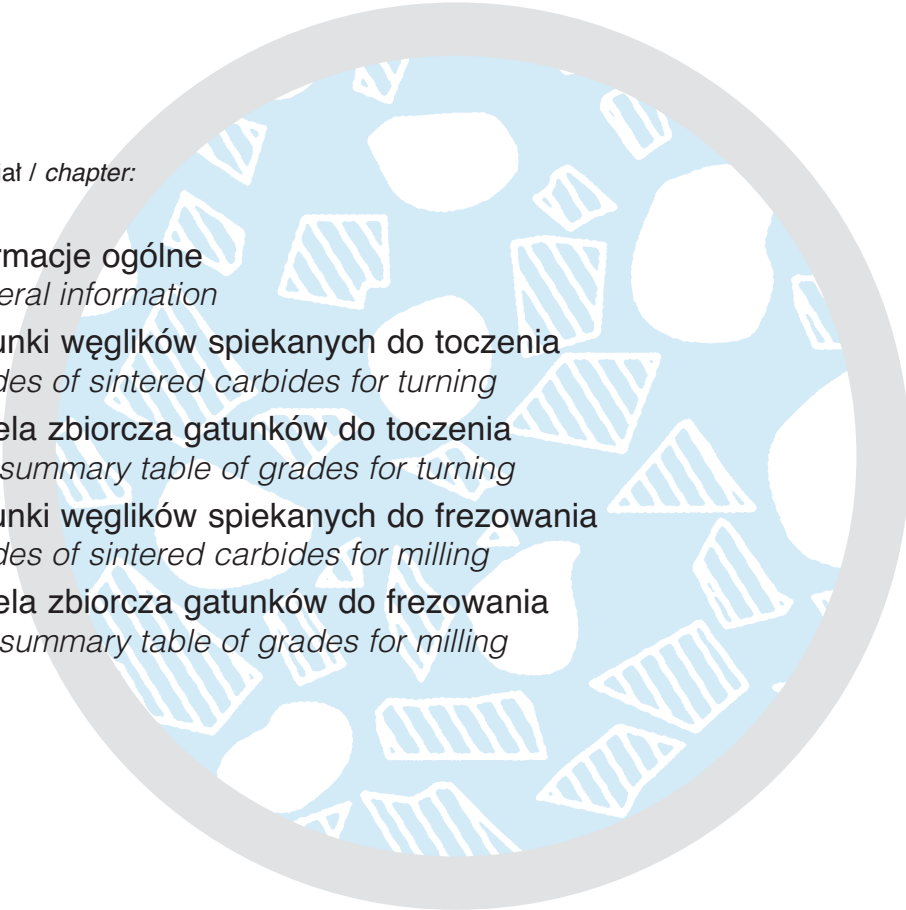
- 
- B2** **Informacje ogólne**
General information
- B5** **Gatunki węglików spiekanych do toczenia**
Grades of sintered carbides for turning
- B8** **Tabela zbiorcza gatunków do toczenia**
The summary table of grades for turning
- B11** **Gatunki węglików spiekanych do frezowania**
Grades of sintered carbides for milling
- B14** **Tabela zbiorcza gatunków do frezowania**
The summary table of grades for milling

Węglik spiekane Baidonit produkowane są w szerokim zakresie gatunków przeznaczonych do różnych zastosowań w obróbce skrawaniem. Poszczególne gatunki różnią się pomiędzy sobą składem chemicznym, właściwościami fizykochemicznymi i użytkowymi.

Płytki wielostrzowe z węglików spiekanych wytwarzane są według technologii metalurgii proszków, z różnych węglików metali jak: węgiel wolframu (WC), węgiel tytanu (TiC), węgiel tantalu (TaC), węgiel niobu (NbC) oraz fazy wiążącej stanowiącej osnowę dla twardych ziaren węglików, którą najczęściej jest kobalt (Co). Właściwości węglików spiekanych zależą przede wszystkim od składu chemicznego i fazowego, kształtu i wielkości ziaren węglików oraz ich udziału objętościowego w strukturze. Każdy gatunek posiada oznaczenie firmowe i jest ponadto zaklasyfikowany do odpowiedniej grupy lub kilku grup zastosowań według międzynarodowej normy ISO 513. Norma ISO (International Standard Organization) klasyfikuje gatunki węglików spiekanych w zależności od rodzaju obrabianego materiału w trzech głównych grupach zastosowania (stal, stal nierdzewna, żeliwo), oznaczonych literami: P, M, K i odpowiednio kolorami: niebieskim, żółtym i czerwonym oraz trzech dodatkowych grupach zastosowania (stopy nieżelazne, stopy żaroodporne i tytanu oraz materiały hartowane), oznaczonych literami: N, S, H i odpowiednio kolorami: zielonym, pomarańczowym i szarym. W obrębie grupy zastosowania, zależnie od warunków obróbki rozróżnia się kilka podgrup oznaczonych literami głównej grupy i cyframi. Wyższa cyfra informuje o większej ciągliwości gatunku węgliku spiekane go lecz niższej odporności na ścieranie. Jednym z najważniejszych etapów rozwoju narzędzi skrawających było wprowadzenie węglików spiekanych pokrywanych cienkimi, twardymi warstwami pokryć tytanowych. Najpopularniejszymi warstwami są pokrycia z węgliku tytanu (TiC), azotku tytanu (TiN), tlenku glinu (Al_2O_3) oraz węglikoazotku tytanu (TiCN). Węgiel tytanu i tlenek glinu to jedne z najtwardszych materiałów o wysokiej odporności na zużycie – starcie na powierzchni przyłożenia. Azotek tytanu nie wykazuje tak wysokiej twardości, lecz odznacza się za to wyższą odpornością na tworzenie krateru na powierzchni natarcia, wykazując niższy współczynnik tarcia oraz posiada atrakcyjny złoty kolor. Zróżnicowane mechanizmy zużycia poszczególnych warstw doprowadziły do produkcji płytek pokrywanych wielowarstwowo metodą CVD – chemicznego wydzielenia warstw pokrywających z fazy gazowej w wysokich temperaturach. Uzupełnieniem oferty są płytki pokrywane metodą PVD – fizycznego wydzielenia warstw pokrywających z fazy gazowej w niskich temperaturach. Przeznaczone są przede wszystkim do obróbki frezowaniem, toczenia gwintu, rowkowania oraz toczenia trudnoobrabialnych materiałów.

Powyższe zalety płytek pokrywanych decydują, że w większości przypadków obróbki skrawaniem (zarówno toczeniem jak i frezowaniem), węgliki spiekane pokrywane zalecane są jako gatunki pierwszego wyboru.



Baildonit sintered carbide grades are produced in a wide range of grades designed for various machining applications. Individual grades differ in their chemical composition, physical, chemical and operational properties.

Sintered carbide indexable inserts are manufactured according to powder metallurgy technology of various metal carbides such as: tungsten carbide (WC), titanium carbide (TiC), tantalum carbide (TaC), niobium carbide (NbC) and a binding phase which constitutes matrix for hard carbide grains – most frequently cobalt (Co). Sintered carbide properties depend mainly on chemical and phase composition, the shape and size of carbide grains and their volume participation in the structure. Every grade bears a corporate designation and is additionally classified into an appropriate application group or several application groups according to an international standard of ISO 513. The International Standard Organisation (ISO) standard classifies sintered carbide grades depending on type of workpiece material in three main application groups (steel, stainless steel, cast iron), bearing P, M, K letters and blue, yellow and red colours respectively. Depending on machining conditions, within an application group there are several sub-groups designated by the main group letters and digits.

A higher digit informs about higher ductility of a sintered carbide grade, but lower abrasive wear. One of the most important stages in cutting tools development was implementation of sintered carbides coated with thin, hard layers of titanium coatings. The most popular coating layers are made of titanium carbide (TiC), titanium nitride (TiN), aluminium oxide (Al_2O_3) and titanium carbonitride (TiCN). Titanium carbide and aluminium oxide belong to the hardest materials with high wear resistance – flank wear. Titanium nitride does not show such hardness but it is characterised by higher resistance to crater wear, with a lower friction factor and has an attractive golden colour. Varied wear mechanisms of individual layers led to production of inserts with multi-layer coating made by a CVD method – chemical vapour deposition – at high temperatures. A supplement to an offer are inserts coated by a PVD method – physical vapour deposition – at low temperatures. They are predominantly designed for milling, threading, grooving and heavy duty turning.

The above-mentioned advantages offered by coated inserts make sintered carbides the first choice in most machining applications (both in turning and milling).

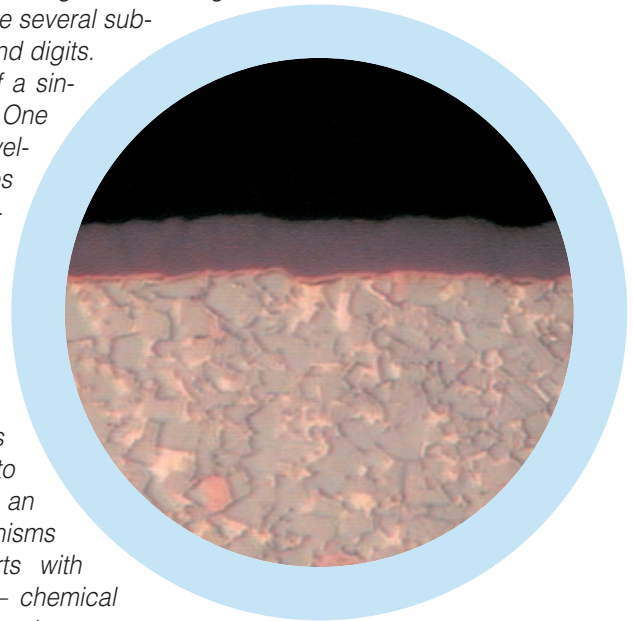

General information

Główne korzyści płynące ze stosowania pokrywanych płytek wielostrzowych to:

- znacznie zwiększona trwałość, kilkakrotnie w porównaniu z płytkami niepokrywanymi, przy niezmiennych parametrach skrawania,
- możliwość zwiększenia wydajności obróbki przez zastosowanie większych prędkości skrawania, przy tym samym okresie trwałości ostrza,
- zmniejszenie tarcia, a w konsekwencji temperatury ostrza i sił skrawania prowadzące do obniżenia poboru mocy obrabiarki,
- zmniejszenie zapasów magazynowych.

Przeważająca liczba płytek pokrywanych stosowana jest do operacji toczenia chociaż w zakresie frezowania płytki pokrywane stają się coraz powszechniejsze dzięki technologicznemu dopracowaniu własności pokryw do warunków obróbki dynamicznej.

W niektórych przypadkach prawidłowe stosowanie płytek pokrywanych wymaga przeprowadzenia prób testowych, pozwalających na dobór odpowiedniego gatunku jak i parametrów obróbki.

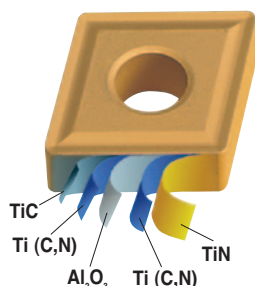

The main benefits resulting from application of coated indexable inserts are:

- prolonged tool life, several times longer than in case of uncoated inserts with the same cutting parameters,
- a possibility to increase productivity by using higher cutting speed with the same cutting edge life,
- lower friction, and consequently lower edge temperature and cutting forces leading to lower power consumption.
- reduction in stocks.

Majority of coated inserts are used for turning, although coated inserts become increasingly popular in milling, owing to technological adjustment of coating properties to dynamic machining conditions. In some cases correct application of coated inserts requires testing to select appropriate grade and machining parameters.

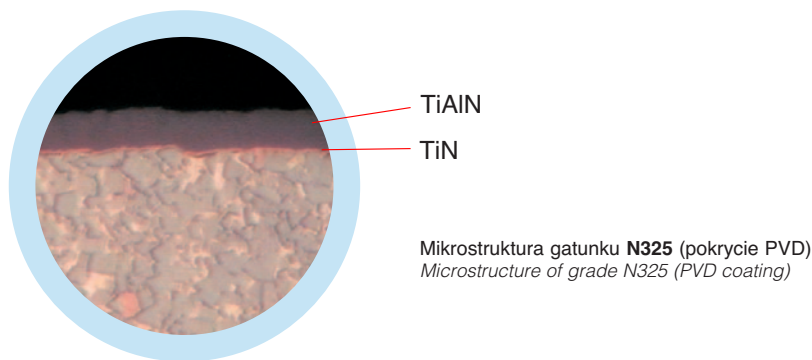

Mikrostruktura gatunku N325 (pokrycie PVD)
Microstructure of grade N325 (PVD coating)

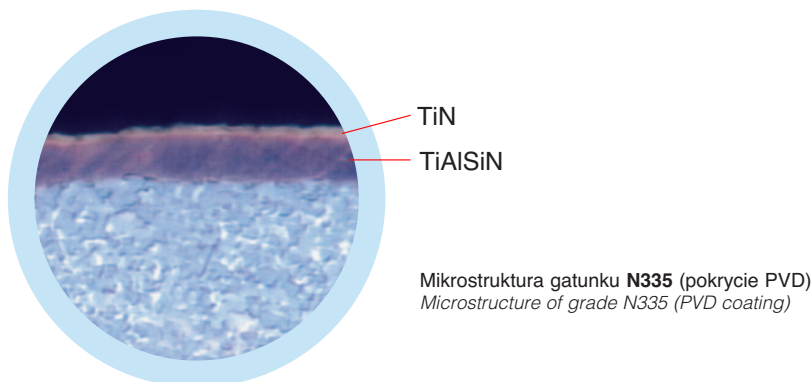

Mikrostruktura gatunku N335 (pokrycie PVD)
Microstructure of grade N335 (PVD coating)

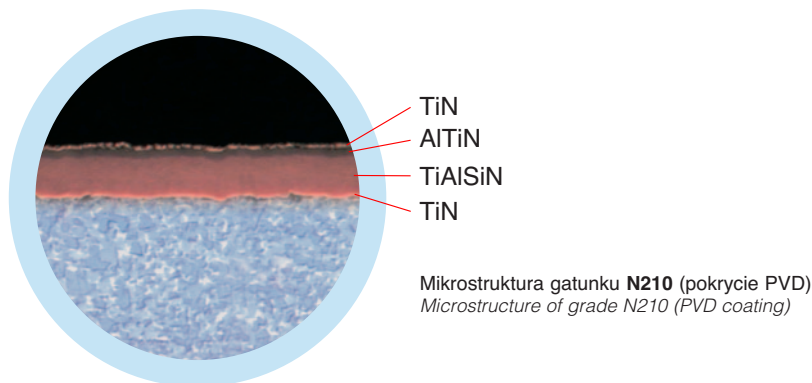

Mikrostruktura gatunku N210 (pokrycie PVD)
Microstructure of grade N210 (PVD coating)

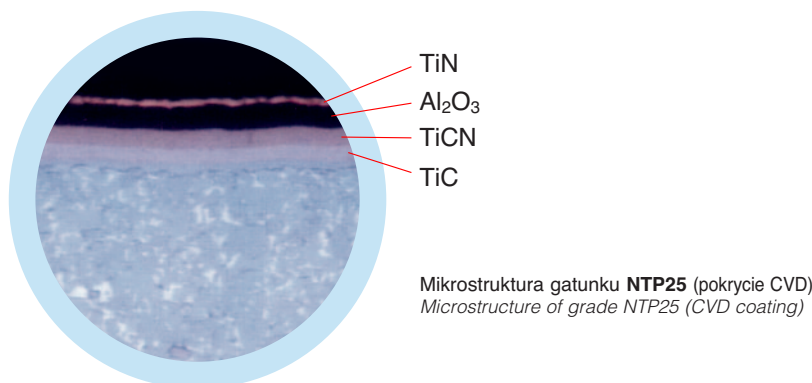

Mikrostruktura gatunku NTP25 (pokrycie CVD)
Microstructure of grade NTP25 (CVD coating)

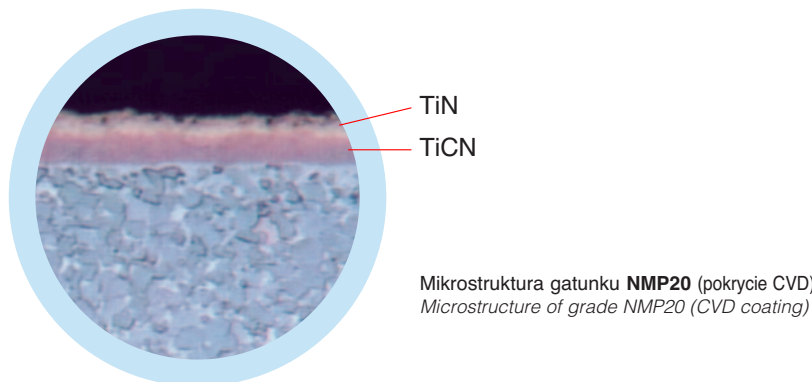

Mikrostruktura gatunku NMP20 (pokrycie CVD)
Microstructure of grade NMP20 (CVD coating)

Gatunki do toczenia

Grades for turning

niepokrywane / *uncoated*

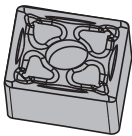
	Oznaczenie <i>Designation</i>	Zakres ISO <i>ISO range</i>	Zastosowanie <i>Applications</i>
	S10S (HW)	P10-P20	Gatunek przeznaczony do obróbki dokładnej i średnodokładnej stali, staliwa oraz staliwa niskostopowego przy dużych prędkościach skrawania i małych posuwach. <i>A grade for finishing and semi-finishing of steel, cast steel and low-alloy cast steel at high cutting speeds and low feeds.</i>
	S20S (HW)	P15-P25	Gatunek przeznaczony do obróbki dokładnej i średnodokładnej stali i staliwa, przy odpowiednio dużych prędkościach skrawania i umiarkowanych posuwach. <i>A grade for finishing and semi-finishing of steel and cast steel at high cutting speeds and moderate feeds.</i>
	SY3 (HW)	P15-P35	Gatunek o wysokiej odporności na wstrząsy cieplne, bardzo wysokiej odporności na zużycie i dobrej wytrzymałości. Zalecany jako gatunek uniwersalny do toczenia rowków. <i>A grade high resistance to thermal shocks. Very high resistance and good toughness. Universal grade, recommended for parting.</i>
	SM25T (HW)	P15-P40 M25-M35	Gatunek przeznaczony do obróbki stali, staliwa i stali nierdzewnych wiórem odpryskowym o dużym przekroju i zmiennej grubości. Odporny na zmęczeniowe obciążenia dynamiczne. Można go stosować przy dużych i średnich prędkościach skrawania oraz dużych przekrojach warstwy skrawanej. <i>A grade for machining of steel, cast steel and stainless steel with a splinter chip of large section and varying thickness. Resistant to dynamic fatigue loads. It can be used at high to moderate cutting speeds and large section of cutting layer.</i>
	S30S (HW)	P25-P35	Gatunek przeznaczony do obróbki średnodokładnej i zgrubnej stali i staliwa przy średnich i małych prędkościach skrawania oraz znacznych przekrojach warstwy skrawanej w trudnych warunkach obróbki. <i>A grade for semi-finishing and roughing of steel and cast steel at moderate and low cutting speeds with large section of cutting layer in difficult conditions.</i>
	H10S (HW)	K10-K20	Gatunek przeznaczony do obróbki dokładnej i średnodokładnej wszystkich gatunków żeliw, stali stopowych, austenitycznych i stopów metali kolorowych oraz materiałów niemetalicznych dających krótki wiór. <i>A grade for finishing and semi-finishing of all kinds of cast irons, alloy steels, austenitic alloys, non-ferrous metals and non-metallic materials giving a short chip.</i>
	H15X (HW)	M15-M25 K15-K30	Gatunek przeznaczony do obróbki wszystkich gatunków żeliw. Można go również stosować do zgrubnego toczenia żeliw, metali nieżelaznych, żaroodpornych stopów niklu. <i>A grade for machining of all kinds of cast irons. It can also be used for roughing of cast irons, non-ferrous metals, heat resistant nickel alloys.</i>
	H20S (HW)	K15-K25	Gatunek przeznaczony do obróbki średnodokładnej i zgrubnej żeliw przy umiarkowanych prędkościach skrawania i średnich oraz dużych posuwach w niekorzystnych i trudnych warunkach obróbki. Nadaje się do obróbki stopów miedzi, stopów lekkich, materiałów żaroodpornych, żarowytrzymałych oraz tworzyw sztucznych. <i>A grade for semi-finishing and roughing of cast irons at moderate cutting speeds, medium and heavy feed under unfavourable conditions. Suitable for machining of copper alloys, light alloys, heat resistant materials and plastics.</i>

P Stal / Steel
M Stal nierdzewna / Stainless steel
K Żeliwo / Cast iron

N Stopy nieżelazne, aluminium
 Non-ferrous alloys, aluminium alloys
S Stopy żaroodporne, stopy tytanu
 Heat resistant steel, titanium alloys
H Materiały hartowane
 Hard materials

HC – gatunek pokrywany / coated grade (PVD, CVD)
HW – gatunek niepokrywany / uncoated grade

Gatunki do toczenia

Grades for turning

pokrywane CVD / coated CVD

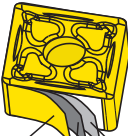
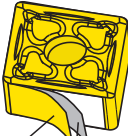
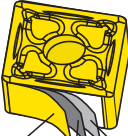
Pokrycie Coating layer	Oznaczenie Designation	Zakres ISO ISO range	Zastosowanie Applications
 TiN Al ₂ O ₃ TiCN	NTP15 (CVD)	P01-P30	Gatunek węgla spiekane pokryty metodą CVD, przeznaczony do obróbki wykańczającej stali i staliwa przy dużych prędkościach skrawania, odznaczający się odpornością na wysoką temperaturę skrawania. <i>A CVD coated sintered carbide grade, designed for finishing of steel and cast steel at high cutting speed, demonstrating resistance to high cutting temperature.</i>
	NTP25 (CVD)	P10-P35	Uniwersalny gatunek węgla spiekane pokryty metodą CVD, przeznaczony do wysoko wydajnej obróbki średniodokładnej stali w niekorzystnych warunkach, odznaczający się dużym bezpieczeństwem krawędzi skrawającej. <i>A universal CVD coated sintered carbide grade, designed for high performance semi-finishing of steel in adverse conditions, demonstrating high cutting edge safety.</i>
	NTP35 (CVD)	P20-P45	Gatunek węgla spiekane pokryty metodą CVD, przeznaczony do obróbki średniej i zgrubnej stali i staliwa w trudnych warunkach obróbki. <i>A CVD coated sintered carbide grade, designed for semi-finishing and roughing of steel and cast steel in difficult machining conditions.</i>
	5735 (MTCVD)	P20-P40 M20-M40 K20-K40 S20-S30	Gatunek węgla spiekane pokryty metodą MT-CVD, przeznaczony do obróbki zgrubnej i średniodokładnej stali, stali nierdzewnej i stali żaroodpornej ze średnimi prędkościami i wysokimi posuwami. Dobrze sprawdza się przy obróbce ciągłej i przerywanej. Gatunek o doskonałej odporności na zużycie i dużej odporności na wykruszenia. <i>An MT-CVD coated sintered carbide grade, designed for roughing and semi-finishing of steel, stainless steel and heat-resistant steel. Medium cutting speed and high feed. Recommended for continuous and interrupted cuts. Excellent wear resistance and high chipping resistance.</i>
 TiN TiCN	NTM25 (CVD)	M15-M35	Gatunek węgla spiekane pokryty metodą CVD, zalecany jako pierwszy wybór do obróbki średniodokładnej i zgrubnej stali nierdzewnych zarówno w warunkach pracy ciągłej, jak i przerywanej, posiadający wysoką odporność na zmienne obciążenie cieplne i mechaniczne. <i>A CVD coated sintered carbide grade, recommended as first choice for semi-finishing and roughing of stainless steel in constant and intermittent machining, demonstrating high resistance to changing thermal and mechanical loads.</i>
	NTM35 (CVD)	M20-M40	Gatunek węgla spiekane pokryty metodą CVD o szczególnie wysokiej odporności na zmienne obciążenia cieplne i mechaniczne, przeznaczony do obróbki zgrubnej stali nierdzewnych. <i>A CVD coated sintered carbide grade, with extremely high resistance to changing thermal and mechanical loads, designed for roughing of stainless steel.</i>
 TiN Al ₂ O ₃ TiCN	NTK05 (CVD)	K01-K20	Gatunek węgla spiekane pokryty metodą CVD o wysokiej odporności na zużycie oraz wysokie temperatury skrawania, przeznaczony do obróbki wykańczającej żeliwa, a szczególnie żeliwa sferoidalnego. <i>A CVD coated sintered carbide grade, with high resistance to wear and high cutting temperatures, designed for finishing of cast iron, in particular spheroidal cast iron.</i>
	NTK25 (CVD)	K10-K30	Gatunek węgla spiekane pokryty metodą CVD, przeznaczony do obróbki żeliwa szarego w trudnych warunkach skrawania, odznaczający się odpornością na wysokie temperatury skrawania. <i>A CVD coated sintered carbide grade, designed for machining of grey cast iron in extremely difficult cutting conditions, demonstrating resistance to high cutting temperatures.</i>

P Stal / Steel

M Stal nierdzewna / Stainless steel

K Żeliwo / Cast iron

N Stopy nieżelazne, aluminium

Non-ferrous alloys, aluminum alloys

S Stopy żaroodporne, stopy tytanu

Heat resistant steel, titanium alloys

H Materiały hartowane

Hard materials

HC – gatunek pokrywany / coated grade (PVD, CVD)

HW – gatunek niepokrywany / uncoated grade

Gatunki do toczenia

Grades for turning

pokrywane PVD / coated PVD

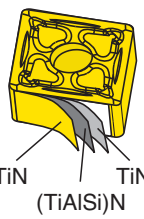
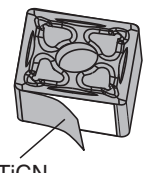
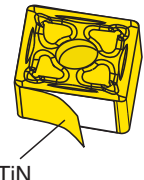
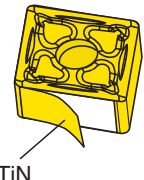
Pokrycie Coating layer	Oznaczenie Designation	Zakres ISO ISO range	Zastosowanie Applications
	N325 (PVD)	P20-P35 M15-M35	Gatunek węgla spiekane pokryty metodą PVD, przeznaczony do wysokowydajnego toczenia stali i stali nierdzewnej w obszarze obróbki średniodokładnej i dokładnej. Zalecany do obróbki z dużymi i średnimi prędkościami skrawania. <i>A sintered carbide grade, PVD-coated, designed for highly-productive turning of steel and stainless steel in semi-finishing and finishing. Recommended for machining at high and medium cutting speeds.</i>
	N335 (PVD)	P20-P40 M20-M40	Gatunek węgla spiekane pokryty metodą PVD, przeznaczony do obróbki z dużymi i małymi prędkościami skrawania stali i stali nierdzewnych, odznaczający się dużą wytrzymałością krawędzi skrawającej. <i>A PVD coated sintered carbide grade, designed for machining at high and low cutting speed, for steel and stainless steel, with high cutting edge resistance.</i>
	N435 (PVD)	P30-P55 M30-M45	Gatunek węgla spiekane pokryty metodą PVD o najwyższej ciągliwości, przeznaczony do przecinania i nacinania rowków w bardzo trudnych warunkach obróbki, szczególnie materiałów o właściwościach przywierających. <i>A PVD coated sintered carbide grade with the highest ductility, designed for parting and grooving in very difficult machining conditions, particularly suitable for sticking materials.</i>
	KX20 (PVD)	S10-S25	Gatunek węgla spiekane pokryty metodą PVD, przeznaczony głównie do obróbki stopów żaroodpornych i stopów tytanu w zakresie obróbki dokładnej. <i>A PVD coated sintered carbide grade designed mainly for machining of heat resistant alloys and titanium alloys in the range of finishing.</i>
	5820 (PVD)	P05-P25 M05-M25	Gatunek węgla spiekane pokryty metodą PVD, przeznaczony do średniodokładnej obróbki stali, stali nierdzewnej, stali żaroodpornej, stopów aluminium i metali nieżelaznych, ze średnimi i wysokimi prędkościami, w obróbce ciągłej i przerywanej, z wysokimi posuwami. Zalecany przy rowkowaniu i przecinaniu. Gatunek o doskonałej odporności na zużycie, dużej odporności na wykruszenia i małej podatności na powstawanie narostu na krawędzi skrawającej. <i>A PVD-coated sintered carbide grade, designed for semi-finishing of steel, stainless steel, heat-resistant steel, aluminum & non-ferrous alloys. Medium to high speed, continuous to interrupted cuts and high feed. Recommended for grooving and parting. Excellent wear resistance, high chipping and crater resistance.</i>
		K10-K25	
N10-N25			
S10-S20			
	OR740 (PVD)	P30-P50 M20-M40	Gatunek węgla spiekane pokryty metodą PVD. Dzięki wysokiej odporności na zmienne obciążenia termiczne nadaje się szczególnie do obróbki stali w trudnych warunkach. <i>A PVD coated sintered carbide grade. Owing to high thermal resistance it is particularly recommended for machining of steel in difficult conditions.</i>
		M20-M40	

P Stal / Steel
M Stal nierdzewna / Stainless steel
K Żeliwo / Cast iron

N Stopy nieżelazne, aluminium
 Non-ferritic alloys, aluminum alloys
S Stopy żaroodporne, stopy tytanu
 Heat resistant steel, titanium alloys
H Materiały hartowane
 Hard materials

HC – gatunek pokrywany / coated grade (PVD, CVD)
HW – gatunek niepokrywany / uncoated grade

GRUPA ISO ISO GROUP	ZAKRES RANGE	TOCZENIE / TURNING		
		CVD	PVD	HW
P	01			
	05			
	10			
	15	NTP15		S10S
	20	NTP25		S20S
	25	NTP35		SM25T
	30		N335	S30S
	35			
	40			
	45			
M	01			
	05			
	10			
	15			
	20	NTM25		
	25	NTM35	N335	SM25T
	30			
	35			
	40			
	45			
K	01			
	05			
	10			
	15			
	20			
	25			
	30			
	35			
	40			
	45			
N	01			
	05			
	10			
	15			
	20			
	25			
	30			
	35			
	40			
	45			
S	01			
	05			
	10			
	15			
	20			
	25			
	30			
	35			
	40			
	45			

P Stal / Steel

M Stal nierdzewna / Stainless steel

K Żeliwo / Cast iron

N Stopy nieżelazne, aluminium

Non-ferritic alloys, aluminium alloys

S Stopy żaroodporne, stopy tytanu

Heat resistant steel, titanium alloys

H Materiały hartowane

Hard materials

HC – gatunek pokrywany / coated grade (PVD, CVD)

HW – gatunek niepokrywany / uncoated grade

	PRZECINANIE I ROWKOWANIE PARTING & GROOVING			ZAKRES RANGE	
	CVD	PVD	HW		
				01	05
				10	15
				20	25
				30	35
				40	45
				50	
				01	05
				10	15
				20	25
				30	35
				40	45
				50	
				01	05
				10	15
				20	25
				30	35
				40	45
				50	
				01	05
				10	15
				20	25
				30	35
				40	45
				50	



B



Gatunki do frezowania

Grades for milling

niepokrywane / *uncoated*

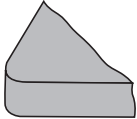
	Oznaczenie <i>Designation</i>	Zakres ISO <i>ISO range</i>	Zastosowanie <i>Applications</i>
	SM25T (HW)	P15-P40	Gatunek przeznaczony do obróbki stali, staliwa i stali nierdzewnych wiórem odpryskowym o dużym przekroju i zmiennej grubości. Odporny na zmęczeniowe obciążenia dynamiczne. Można go stosować przy dużych i średnich prędkościach skrawania oraz dużych przekrojach warstwy skrawanej. <i>A grade for machining of steel, cast steel and stainless steel with a splinter chip of large section and varying thickness. Resistant to dynamic fatigue loads. It can be used at high to moderate cutting speeds and large section of cut layer.</i>
		M25-M35	
	H10S (HW)	K10-K20	Gatunek przeznaczony do obróbki dokładnej i średniodokładnej wszystkich gatunków żeliw, stopów metali kolorowych oraz materiałów niemetalicznych dających krótki wiór. <i>A grade for finishing and semi-finishing of all kinds of cast irons, non-ferrous alloys and non-metallic materials giving a short chip.</i>
		N05-N25	
	H15X (HW)	M15-M25	Gatunek przeznaczony do obróbki wszystkich gatunków żeliw. Można go również stosować do zgrubnego toczenia żeliw, metali nieżelaznych, żaroodpornych stopów niklu. <i>A grade for machining of all kinds of cast irons. Also it can be used for roughing of cast irons, non-ferrous metals, heat-resistant nickel alloys.</i>
K15-K30			
H20S (HW)	K15-K25	Gatunek przeznaczony do obróbki średniodokładnej i zgrubnej żeliw przy umiarkowanych prędkościach skrawania i średnich oraz dużych posuwach w niekorzystnych i trudnych warunkach obróbki. Nadaje się do obróbki stopów miedzi, stopów lekkich, materiałów żaroodpornych, żarowytrzymałych oraz tworzyw sztucznych. <i>A grade for semi-finishing and roughing of cast irons at moderate cutting speeds, medium and heavy feed under unfavourable conditions. Suitable for machining of copper alloys, light alloys, heat resistant alloys and plastics.</i>	

P Stal / Steel

M Stal nierdzewna / Stainless steel

K Żeliwo / Cast iron

N Stopy nieżelazne, aluminium
Non-ferritic alloys, aluminium alloys

S Stopy żaroodporne, stopy tytanu
Heat resistant steel, titanium alloys

H Materiały hartowane
Hard materials



HC – gatunek pokrywany / coated grade (PVD, CVD)

HW – gatunek niepokrywany / uncoated grade

Gatunki do frezowania

Grades for milling

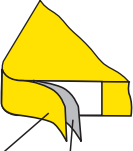
pokrywane CVD / coated CVD

Pokrycie Coating layer	Oznaczenie Designation	Zakres ISO ISO range	Zastosowanie Applications
 TiN TiCN	NMP20 (CVD)	P15-P35	Gatunek węgla spiekanego pokryty metodą CVD, przeznaczony do frezowania średniodokładnego i zgrubnego stali z możliwie najwyższą wydajnością obróbki. <i>A CVD coated sintered carbide grade designed for semi-finishing and roughing of steel with highest possible productivity.</i>
 Al ₂ O ₃ TiCN	NMK20 (CVD)	K10-K30	Gatunek węgla spiekanego pokryty metodą CVD, przeznaczony do frezowania średniodokładnego i zgrubnego żeliwa szarego głównie w warunkach suchej obróbki, ze średnimi i dużymi prędkościami skrawania. <i>A CVD coated sintered carbide grade, designed for semi-finishing and roughing of grey cast iron, in particular in dry machining, at medium and high cutting speed.</i>
	NMK30 (CVD)	K20-K35	Gatunek węgla spiekanego pokryty metodą CVD, przeznaczony do frezowania żeliw w trudnych warunkach z udziałem emulsji chłodzących, z małymi i średnimi prędkościami skrawania. <i>A CVD coated sintered carbide grade, designed for milling of cast iron in difficult conditions with cooling liquids, at low and medium cutting speed.</i>
 TiN Al ₂ O ₃ TiCN	5135 (CVD)	P25-P45 M20-M40 S20-S30	Gatunek węgla spiekanego pokryty metodą MT-CVD, przeznaczony do obróbki ciągłej i przerywanej, zgrubnej i średniodokładnej stali i stali nierdzewnej, stopów tytanu i stali żaroodpornej o twardości do 300 HB. <i>A MT-CVD coated sintered carbide designed for roughing and semi-finishing of steels and stainless steel for continuous and interrupted cuts. It also provides high performance for machining of titanium alloys and heat resistant alloys with 300 HB hardness.</i>

P Stal / Steel

M Stal nierdzewna / Stainless steel

K Żeliwo / Cast iron

N Stopy nieżelazne, aluminium
Non-ferritic alloys, aluminium alloys

S Stopy żaroodporne, stopy tytanu
Heat resistant steel, titanium alloys

H Materiały hartowane
Hard materials

HC – gatunek pokrywany / coated grade (PVD, CVD)

HW – gatunek niepokrywany / uncoated grade

Gatunki do frezowania

Grades for milling

pokrywane PVD / coated PVD

Pokrycie Coating layer	Oznaczenie Designation	Zakres ISO ISO range	Zastosowanie Applications	
	N210 (PVD)	P05-P20	Gatunek węgla spiekane pokryty metodą PVD, przeznaczony do dokładnego i średniodokładnego frezowania stali, stali nierdzewnych i żeliw, szczególnie w zakresie wyższych twardości, a także aluminium i materiałów hartowanych z wysokimi prędkościami skrawania, przy znacznym obciążeniu cieplnym płytek. <i>A PVD coated sintered carbide grade, designed for finishing and semi-finishing milling of steel, stainless steel and cast iron, particularly recommended for higher hardness, as well as aluminium and hard treated materials at high cutting speed and with high thermal loads.</i>	
		M05-M20		
		K05-K25		
		N05-N25		
		S05-S15		
		H05-H15		
	N250 (PVD)	P05-P20	Gatunek węgla spiekane pokryty metodą PVD, przeznaczony do dokładnego frezowania stali zwykłych i materiałów wykazujących tendencję do przywierania, tj. stali niskowęglowej, stali nierdzewnych oraz materiałów utwardzanych powierzchniowo. <i>A PVD coated sintered carbide grade, designed for finishing of ordinary steel and sticking materials i.e. low-carbon steel, stainless steel and roughed materials.</i>	
		M10-M20		
	N300 (PVD)	M15-M35	Gatunek węgla spiekane pokryty metodą PVD, przeznaczony do frezowania stali nierdzewnych (przede wszystkim stali austenitycznych), ze średnimi i dużymi prędkościami skrawania. <i>A PVD coated sintered carbide grade, designed for milling of stainless steel (mainly austenitic steel) at medium and high cutting speed.</i>	
		N350 (PVD)		P10-P40
				M20-M35
		N435 (PVD)		P30-P55
				M30-M45
	2003 (PVD)	P05-P10	Drobnziarnisty gatunek węgla spiekane pokryty metodą PVD (TiAlN). Doskonała odporność na zużycie. Przede wszystkim do obróbki wykańczającej materiałów twardych i stali, obróbki dokładnej i średniodokładnej stali nierdzewnej i stopów żaroodpornych. Także może być stosowany do obróbki dokładnej żeliwa. <i>Submicrograin carbide with PVD coating (TiAlN), color gray. Excellent wear resistance. First choice for finishing of hard material and steel, finishing and semi-finishing for stainless steel and heat-resistant alloys. Second choice finishing for cast-iron.</i>	
		M05-M15		
		K01-K10		
		S01-S10		
		H05-H15		
	5020 (PVD)	P10-P30	Gatunek węgla spiekane pokryty metodą PVD do średniodokładnego i wykańczającego frezowania stali zwykłych, stali nierdzewnych, stopów żaroodpornych i stopów tytanu z wysokimi prędkościami skrawania. <i>A PVD coated sintered carbide grade designed for semi-finishing and finishing milling normal and stainless steel, heat resistant and titanium alloys with high cutting speed.</i>	
		M10-M25		
		S10-S20		
	5050 (PVD)	P30-P50	Gatunek węgla spiekane pokryty metodą PVD do średniodokładnego i zgrubnego frezowania stali zwykłych i stali nierdzewnych. Charakteryzuje się dużą odpornością na zmienne obciążenia mechaniczne oraz szoki termiczne. <i>A PVD coated sintered carbide grade designed for semi-finishing and roughing milling normal and stainless steel. Highly resistant to changing loads and thermal shocks.</i>	
		M20-M40		

GRUPA ISO ISO GROUP	ZAKRES RANGE	FREZOWANIE / MILLING	
		CVD	PVD
P	01		
	05		
	10		N210 N250
	15		
	20	NMP20	N350
	25		
	30		
	35	5135	N435
	45		
50			
M	01		
	05		
	10		N210 N250
	15		
	20		N300 N350
	25		
	30	5135	N435
	35		
	45		
50			
K	01		
	05		
	10		N210
	15	NMK20	
	20		
	25	NMK30	
	30		
	35		
	45		
50			
N	01		
	05		
	10		N210
	15		
	20		
	25		
	30		
	35		
	45		
50			
S	01		
	05		
	10		N210
	15	5135	
	20		
	25		
	30		
	35		
	45		
50			
H	01		
	05		
	10		N210
	15		
	20		
	25		
	30		
	35		
	45		
50			

		HW		ZAKRES RANGE	
				01	
				05	
				10	
				15	
				20	
				25	
				30	
				35	
				40	
				45	
				50	
				01	
				05	
				10	
				15	
				20	
				25	
				30	
				35	
				40	
				45	
				50	
				01	
				05	
				10	
				15	
				20	
				25	
				30	
				35	
				40	
				45	
				50	
				01	
				05	
				10	
				15	
				20	
				25	
				30	
				35	
				40	
				45	
				50	
				01	
				05	
				10	
				15	
				20	
				25	
				30	
				35	
				40	
				45	
				50	
				01	
				05	
				10	
				15	
				20	
				25	
				30	
				35	
				40	
				45	
				50	

P Stal / Steel
M Stal nierdzewna / Stainless steel
K Żeliwo / Cast iron

N Stopy nieżelazne, aluminium
 Non-ferritic alloys, aluminium alloys
S Stopy żaroodporne, stopy tytanu
 Heat resistant steel, titanium alloys
H Materiały hartowane
 Hard materials

HC – gatunek pokrywany / coated grade (PVD, CVD)
HW – gatunek niepokrywany / uncoated grade



PŁYTKI DO TOCZENIA

INSERTS FOR TURNING

str. / page: rozdział / chapter:

- C2 Oznaczenie płytek do toczenia
Designation of inserts for turning
- C4 Płytki do toczenia
Inserts for turning
- C22 Płytki do przecinania
Inserts for parting
- C23 Płytki do rowkowania X61..
Inserts for grooving X61..
- C24 Płytki do rowkowania z roztaczaniem X92..
Inserts for grooving and recessing X92..
- C26 Płytki podporowe i łamacze wióra
Shims and chipbreakers

T

N

M

G

22

1. Kształt płytki i kąt naroża ϵ_r

Insert shape and angle ϵ_r

2. Kąt przyłożenia normalny α_n

Normal clearance angle α_n

3. Dokładność płytki

Tolerance class

4. Kształt powierzchni natarcia i sposób mocowania płytki
Chipbreaker and clamping type

5. Długość boku płytki

Edge length

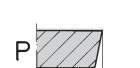
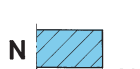
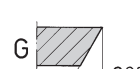
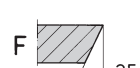
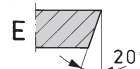
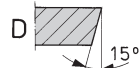
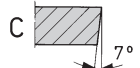
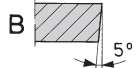
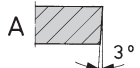
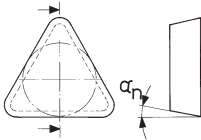
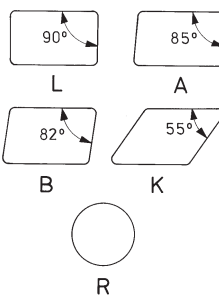
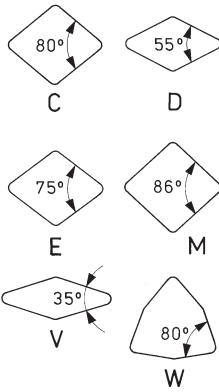
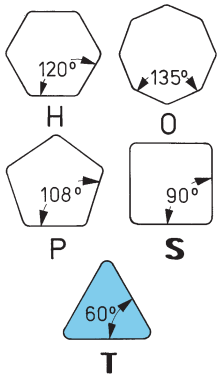

O – inne others

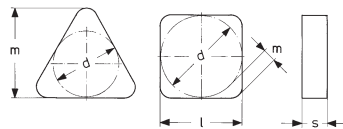

Tolerancja (mm) Tolerance		
l(d)	m	s
±0,025	±0,005	±0,025
A ¹⁾		
±0,013	±0,005	±0,025
F ¹⁾		
±0,025	±0,013	±0,025
C ¹⁾		
±0,013	±0,013	±0,025
H		
±0,025	±0,025	±0,025
E		
±0,025	±0,025	±0,13
G		
±0,05 ±0,15 ²⁾	±0,005	±0,025
J ¹⁾		
±0,05 ±0,15 ²⁾	±0,013	±0,025
K ¹⁾		
±0,05 ±0,15 ²⁾	±0,025	±0,025
L ¹⁾		
±0,05 ±0,15 ²⁾	±0,08 ±0,20 ²⁾	±0,13
M		
±0,05 ±0,15 ²⁾	±0,08 ±0,20 ²⁾	±0,025
N		
±0,08 ±0,25 ²⁾	±0,13 ±0,38 ²⁾	±0,13
U		

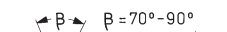
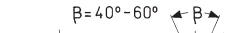

X – wykonanie specjalne
tailor-made inserts

1) Odchyłki te stosuje się dla płytek szlifowanych ze ścinami
These tolerance classes apply to ground indexable inserts with wiper edge
2) Wartości odchyłek (od-do) w zależności od wielkości „d”
Values of deviations (from-to) according to insert size „d”

04

08

E

N

PC

6. Grubość płytki
Insert thickness

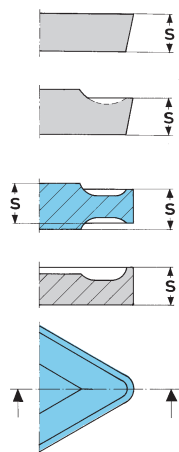

7. Promień naroża r_ϵ
Corner radius r_c

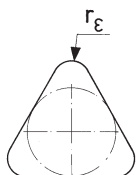

Symbol	r_c (mm)
00	<0,2
02	0,2
04	0,4
08	0,8
24	2,4
x	inne others
00	dla płytek okrągłych for round inserts
MO	

Symbol	s (mm)
01	1,59
T1	1,98
02	2,38
03	3,18
T3	3,97
04	4,76
05	5,56
06	6,35
07	7,94
09	9,52
12	12,70

8. Postać krawędzi skrawającej
Cutting edge condition

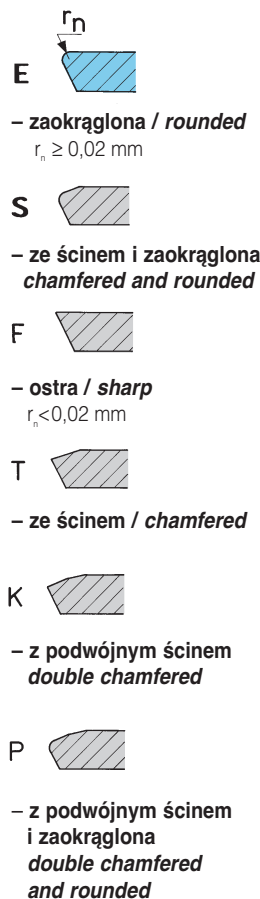

9. Kierunek skrawania
Cutting direction

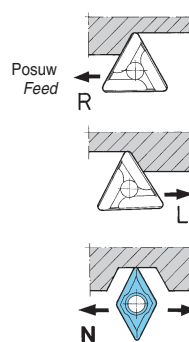

10. Symbol ustalony przez producenta np. geometria łamacza wiórów

Manufacturer's optional symbol e.g. chipbreaker geometry

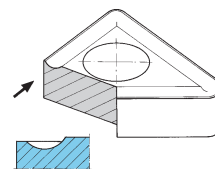

Symbole dodatkowe
Additional symbols

d (mm)	Płytki okrągłe Round inserts
	R
5,0	05
6,0	06
8,0	08
9,525	09
10,0	10
12,0	12
12,70	12
15,875	15
16,0	16
19,05	19
20,0	20
25,0	25
25,4	25
31,75	31
32,0	32

l (d) (mm)	Tolerancje for l (d)		Tolerancje mm for m			
	Dokładność płytki Tolerance class		Tolerance class			
	J,K,L,M,N	U	M i N	U i M	M	
	Kształt płytki Insert shape		Insert shape			
	H,O,P,S,T,C,D,E,M,W,R	H,O,P,S,T,C,E,N,W,R	D			
4,76						
5,56						
6,35 (6)	±0,05	±0,08	±0,08	±0,13	±0,11	
7,94 (8)						
9,525 (10)						
12,7 (12)	±0,08	±0,13	±0,13	±0,20	±0,15	
15,875 (16)						
19,05 (20)	±0,10	±0,18	±0,15	±0,27	±0,18	
25,4 (25)	±0,13	±0,25	±0,18	±0,38		
31,75 (32)	±0,15	±0,25	±0,20	±0,38		

Uzupełnienie do punktu 3

Supplement to point 3

Uzupełnienie do punktu 5

Supplement to point 5

l (d) (mm)	Symbol literowy określający kształt płytki Symbol for insert shape													
	H	O	P	S	T	C	D	E	M	V	W			
	4,76	-	-	-	04	08	04	05	04	04	08	-		
5,56	-	-	-	05	09	05	06	05	05	09	03			
6,35	03	02	04	06	11	06	07	06	06	11	04			
7,94	04	03	05	07	13	08	09	08	07	13	05			
9,525	05	04	07	09	16	09	11	09	09	16	06			
12,70	07	05	09	12	22	12	15	13	12	22	08			
15,875	09	06	11	15	27	16	19	16	15	27	10			
19,05	11	07	13	19	33	19	23	19	19	33	13			
25,40	14	10	18	25	44	25	31	26	25	44	17			
31,75	18	13	23	31	54	32	38	32	31	54	21			

CNMG

CNMG

CNMG ..R

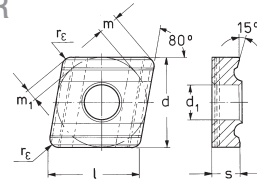
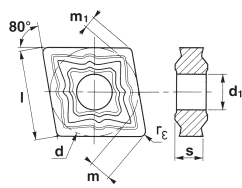

	Oznaczenie Designation	l (mm)	d (mm)	s (mm)	rε (mm)	d1 (mm)	m (mm)	m1 (mm)	gatunki / grades																		
									CVD					PVD		HW											
									NTP15	NTP25	NTP35	NTM25	NTM35	NTK05	NTK25	N325	N335	S10S	S20S	SM25T	S30S	H10S	H15X	H20S			
	12 CNMG 120404-PB	12,9	12,70	4,76	0,4	5,16	3,308	1,818	○	○					●												
	12 CNMG 120404-12	12,9	12,70	4,76	0,4	5,16	3,308	1,818	○																		
	12 CNMG 120408-PC	12,9	12,70	4,76	0,8	5,16	3,088	1,697	○	○	○				●	●											
	12 CNMG 120412-PC	12,9	12,70	4,76	1,2	5,16	2,867	1,576	○	○	○				○	○											
	19 CNMG 190612-PC	19,3	19,05	6,35	1,2	7,93	4,632	2,545	○	○	●				○	●											
	12 CNMG 120404-SM	12,9	12,70	4,76	0,4	5,16	3,308	1,818	○	○	●				●												
	CNMG 120408-SM	12,9	12,70	4,76	0,8	5,16	3,088	1,697	○	○	●				●												
	12 CNMG 120404	12,9	12,70	4,76	0,4	5,16	3,308	1,818	○	○	●			○						○						○	
	CNMG 120408	12,9	12,70	4,76	0,8	5,16	3,088	1,697	○	●	●	○		○						○						○	
	CNMG 120412	12,9	12,70	4,76	1,2	5,16	2,867	1,576	○	●	●				○					○							
	19 CNMG 190612	19,3	19,05	6,35	1,2	7,93	4,632	2,545	○	○	○									●	○						
	CNMG 190616	19,3	19,05	6,35	1,6	7,93	4,411	2,424	○	○	○																
	12 CNMG 120404-13	12,9	12,70	4,76	0,4	5,16	3,308	1,818	○	○																	
	CNMG 120408-13	12,9	12,70	4,76	0,8	5,16	3,088	1,697	○	○																	
	CNMG 120412-13	12,9	12,70	4,76	1,2	5,16	2,867	1,576	○	○	○																
	12 CNMG 120408R	12,9	12,70	4,76	0,8	5,16	3,088	1,697	○	○	○				●												
	CNMG 120408L	12,9	12,70	4,76	0,8	5,16	3,088	1,697	○	○	○																
	CNMG 120412R	12,9	12,70	4,76	0,8	5,16	3,088	1,697	○	○	●				○												
	CNMG 120412L	12,9	12,70	4,76	0,8	5,16	3,088	1,697	○	○	○																
	12 CNMG 120408-PD	12,9	12,70	4,76	0,8	5,16	3,088	1,697							●												
	CNMG 120412-PD	12,9	12,70	4,76	1,2	5,16	2,867	1,576							●												
	19 CNMG 190616-PD	19,3	19,05	6,35	1,6	7,93	4,632	2,545							●												
	19 CNMG 190612-26	19,3	19,05	6,35	1,2	7,93	4,632	2,545		○					●												
	CNMG 190616-26	19,3	19,05	6,35	1,6	7,93	4,411	2,424		○																	

Przykład zamówienia / Ordering example: CNMG 120404-PB, NTP25 – 10 szt. / pcs

CVD, PVD (HC) - gatunek pokrywany / coated grade

(HW) - gatunek niepokrywany / uncoated grade

● - pierwszy wybór / first choice

Płytki do toczenia

Inserts for turning

CNMA
CNMM
CNMG

CNMA

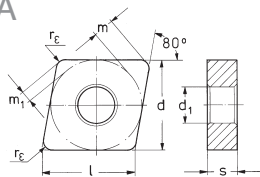

CNMM

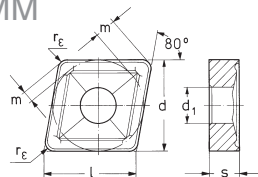

CNMG

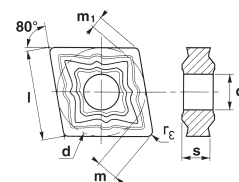

	Oznaczenie Designation	l (mm)	d (mm)	s (mm)	r _e (mm)	d ₁ (mm)	m (mm)	m ₁ (mm)	gatunki / grades														
									CVD						PVD			HW					
									NTP15	NTP25	NTP35	NTM25	NTM35	NTK05	NTK25	N325	N335	S10S	S20S	SM25T	S30S	H10S	H15X
	12 CNMM 120408	12,9	12,70	4,76	0,8	5,16	3,088	1,697															
	19 CNMM 120412	12,9	12,70	4,76	1,2	5,16	2,867	1,576															
	19 CNMM 190612	19,3	19,05	6,35	1,2	7,93	4,632	2,545															
	19 CNMM 190612-53	19,3	19,05	6,35	1,2	7,93	4,632	2,545			●												
	19 CNMM 190612-PD1	19,3	19,05	6,35	1,2	7,93	4,632	2,545			●												
	CNMM 190616-PD1	19,3	19,05	6,35	1,6	7,93	4,411	2,424			○												
	19 CNMM 190616-PD1	19,3	19,05	6,35	1,6	7,93	4,411	2,424			○												
	12 CNMG 120404-MB	12,9	12,70	4,76	0,4	5,16	3,308	1,818							●	●							
	19 CNMG 120408-MB	12,9	12,70	4,76	0,8	5,16	3,088	1,697							●	●							
	12 CNMG 120404-MC	12,9	12,70	4,76	0,4	5,16	3,308	1,818							●	●							
	19 CNMG 120408-MC	12,9	12,70	4,76	0,8	5,16	3,088	1,697							●	●							
	12 CNMA 120404	12,9	12,70	4,76	0,4	5,16	3,308	1,818							○	○							
	19 CNMA 120408	12,9	12,70	4,76	0,8	5,16	3,088	1,697							○	○							
	19 CNMA 120412	12,9	12,70	4,76	1,2	5,16	2,867	1,576							○	○							
	19 CNMA 190612	19,3	19,05	6,35	1,2	7,93	4,632	2,545							○	○							
	19 CNMA 190616	19,3	19,05	6,35	1,6	7,93	4,411	2,424							○	○							
	12 CNMG 120408-KC	12,9	12,70	4,76	0,8	5,16	3,088	1,697							○	○							
	19 CNMG 120412-KC	12,9	12,70	4,76	1,2	5,16	2,867	1,576							○	○							
	19 CNMG 190612-KC	19,3	19,05	6,35	1,2	7,93	4,632	2,545							○	●							
	12 CNMG 120404-23	12,9	12,70	4,76	0,4	5,16	3,308	1,818														○	○
	19 CNMG 120408-23	12,9	12,70	4,76	0,8	5,16	3,088	1,697														○	○

Przykład zamówienia / Ordering example: CNMM 120408, NTP35 – 10 szt. / pcs

CVD, PVD (HC) - gatunek pokrywany / coated grade
 (HW) - gatunek niepokrywany / uncoated grade

● - pierwszy wybór / first choice

Płytki do toczenia

Inserts for turning

DNMG
RNMG

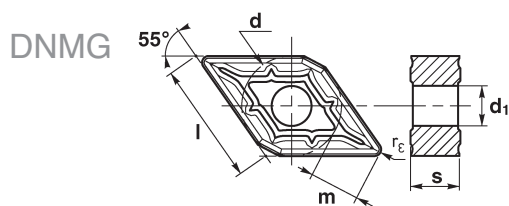

RNMG

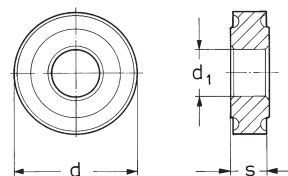

	Oznaczenie Designation	l (mm)	d (mm)	s (mm)	r _e (mm)	d ₁ (mm)	m (mm)	gatunki / grades														
								CVD						PVD		HW						
								NTP15	NTP25	NTP35	NTM25	NTM35	NTK05	NTK25	N325	N335	S10S	S20S	SM25T	S30S	H10S	H15X
	15 DNMG 150604-PB DNMG 150608-PB	15,5 15,5	12,70 12,70	6,35 6,35	0,4 0,8	5,16 5,16	6,939 6,477	○	○					●								
	15 DNMG 150604-PC DNMG 150608-PC DNMG 150612-PC	15,5 15,5 15,5	12,70 12,70 12,70	6,35 6,35 6,35	0,4 0,8 1,2	5,16 5,16 5,16	6,939 6,477 6,014	○	●	○				●	●							
	15 DNMG 150604 DNMG 150608 DNMG 150612	15,5 15,5 15,5	12,70 12,70 12,70	6,35 6,35 6,35	0,4 0,8 1,2	5,16 5,16 5,16	6,939 6,477 6,014	○	○	○			○					○				
	15 DNMG 150604-SM DNMG 150608-SM	15,5 15,5	12,70 12,70	6,35 6,35	0,4 0,8	5,16 5,16	6,939 6,477	○	○					●								
	15 DNMG 150604-MC DNMG 150608-MC	15,5 15,5	12,70 12,70	6,35 6,35	0,4 0,8	5,16 5,16	6,939 6,477			○	○			●	●							
	15 DNMG 150608-KC DNMG 150612-KC	15,5 15,5	12,70 12,70	6,35 6,35	0,8 1,2	5,16 5,16	6,477 6,014							○	○							
	09 12 15 19 25 RNMG 090300 RNMG 120400 RNMG 150600 RNMG 190600 RNMG 250900		9,525 12,70 15,875 19,05 25,40	3,18 4,76 6,35 6,35 9,12		3,81 5,16 6,35 7,93 9,12		○	○	○	○	○		○								

Przykład zamówienia / Ordering example: DNMG 150604-PB, NTP25 – 10 szt. / pcs

CVD, PVD (HC) - gatunek pokrywany / coated grade
(HW) - gatunek niepokrywany / uncoated grade

● - pierwszy wybór / first choice

Płytki do toczenia

Inserts for turning

SNMA
SNMM
SNMG

SNMA

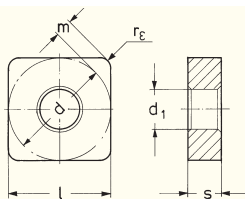

SNMM

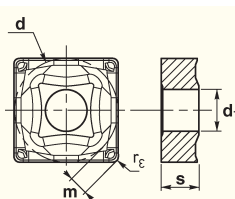

SNMG

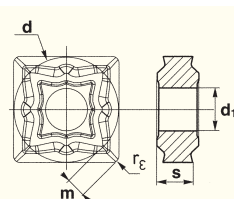

	Oznaczenie Designation	l=d (mm)	s (mm)	r _e (mm)	d ₁ (mm)	m (mm)	gatunki / grades																	
							CVD						PVD			HW								
							NTP15	NTP25	NTP35	NTM25	NTM35	NTK05	NTK25	N325	N335	S10S	S20S	SM25T	S30S	H10S	H15X	H20S		
	09	SNMG 090308-PC	9,525	3,18	0,8	3,81	1,644																	
	12	SNMG 120404-PC	12,70	4,76	0,4	5,16	2,466																	
		SNMG 120408-PC	12,70	4,76	0,8	5,16	2,301																	
		SNMG 120412-PC	12,70	4,76	1,2	5,16	2,137																	
		SNMG 120416-PC	12,70	4,76	1,6	5,16	1,973																	
		15	SNMG 150612-PC	15,87	6,35	1,2	6,35	2,795																
		19	SNMG 190612-PC	19,05	6,35	1,2	7,93	3,452																
SNMG 190616-PC	19,05		6,35	1,6	7,93	3,288																		
	09	SNMG 090308	9,525	3,18	0,8	3,81	1,644																	
	12	SNMG 120404	12,70	4,76	0,4	5,16	2,466																	
		SNMG 120408	12,70	4,76	0,8	5,16	2,301																	
		SNMG 120412	12,70	4,76	1,2	5,16	2,137																	
		SNMG 190612	19,05	6,35	1,2	7,93	3,452																	
		SNMG 190616	19,05	6,35	1,6	7,93	3,288																	
	12	SNMG 120408-13	12,70	4,76	0,8	5,16	2,301																	
		SNMG 120412-13	12,70	4,76	1,2	5,16	2,137																	
	12	SNMG 120408-R	12,70	4,76	0,8	5,16	2,301																	
		SNMG 120408-L	12,70	4,76	0,8	5,16	2,301																	
		SNMG 120412-R	12,70	4,76	1,2	5,16	2,137																	
		SNMG 120412-L	12,70	4,76	1,2	5,16	2,137																	
	12	SNMM 120408-R	12,70	4,76	0,8	5,16	2,301																	
		SNMM 120408-L	12,70	4,76	0,8	5,16	2,301																	
		SNMM 120412-R	12,70	4,76	1,2	5,16	2,137																	
		SNMM 120412-L	12,70	4,76	1,2	5,16	2,137																	
	12	SNMM 120408-53	12,70	4,76	0,8	5,16	2,301																	
		SNMM 120412-53	12,70	4,76	1,2	5,16	2,137																	
	19	SNMM 190612-53	19,05	6,35	1,2	7,93	3,452																	
		SNMM 190616-53	19,05	6,35	1,6	7,93	3,288																	
	12	SNMM 120408	12,70	4,76	0,8	5,16	2,301																	
		SNMM 120412	12,70	4,76	1,2	5,16	2,137																	
	19	SNMM 190612	19,05	6,35	1,2	7,93	3,452																	
		SNMM 190616	19,05	6,35	1,6	7,93	3,288																	
		SNMM 250724	25,40	7,94	2,4	9,12	4,274																	
	12	SNMG 120408-PD	12,70	4,76	0,8	5,16	2,301																	
		SNMG 120412-PD	12,70	4,76	1,2	5,16	2,137																	
	19	SNMG 190612-26	19,05	6,35	1,2	7,93	3,452																	
		SNMG 190616-26	19,05	6,35	1,6	7,93	3,288																	

Przykład zamówienia / Ordering example: SNMG 090308-PC, NTP35 – 10 szt. / pcs

CVD, PVD (HC) - gatunek pokrywany / coated grade

(HW) - gatunek niepokrywany / uncoated grade

● - pierwszy wybór / first choice

SNMA
SNMM
SNMG

SNMA

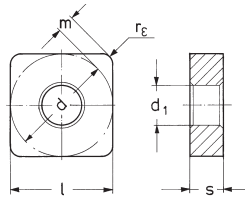

SNMM

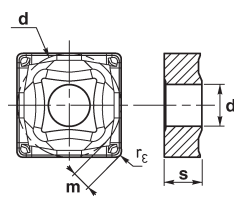

SNMG

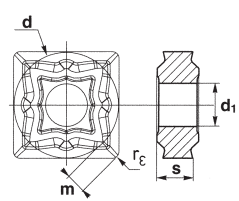

C	Oznaczenie Designation	l=d (mm)	s (mm)	r _e (mm)	d ₁ (mm)	m (mm)	gatunki / grades													
							CVD					PVD		HW						
							NTP15	NTP25	NTP35	NTM25	NTM35	NTK05	NTK25	N325	N335	S10S	S20S	SM25T	S30S	H10S
	19 SNMM 190612-26 SNMM 190616-26	19,05 19,05	6,35 6,35	1,2 1,6	7,93 7,93	3,452 3,288														
	25 SNMM 250724-57	25,40	7,94	2,4	9,12	4,274														
	19 SNMM 190612-PD1 SNMM 190616-PD1	19,05 19,05	6,35 6,35	1,2 1,6	7,93 7,93	3,452 3,288														
	12 SNMG 120408-MB	12,70	4,76	0,8	5,16	2,301														
	12 SNMA 120408 19 SNMA 120412 SNMA 190612 SNMA 190616	12,70 12,70 19,05 19,05	4,76 4,76 6,35 6,35	0,8 1,2 1,2 1,6	5,16 5,16 7,93 7,93	2,301 2,137 3,452 3,288														
	12 SNMG 120408-KC 15 SNMG 120412-KC 19 SNMG 150612-KC SNMG 190612-KC	12,70 12,70 15,87 19,05	4,76 4,76 6,35 6,35	0,8 1,2 1,2 1,2	5,16 5,16 6,35 7,93	2,301 2,137 2,795 3,452														
	12 SNMG 120408-23	12,70	4,76	0,8	5,16	2,301														

Przykład zamówienia / Ordering example: SNMM 190612-26, NTP35 – 10 szt. / pcs

CVD, PVD (HC) - gatunek pokrywany / coated grade
(HW) - gatunek niepokrywany / uncoated grade
● - pierwszy wybór / first choice

Płytki do toczenia

Inserts for turning

**TNMA
TNMM
TNMG**

TNMA

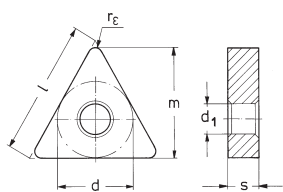

TNMM

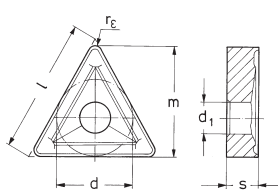

TNMG

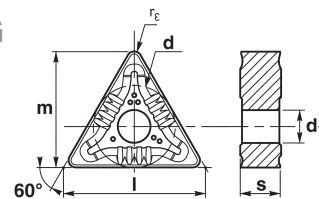

		Oznaczenie Designation	l (mm)	d (mm)	s (mm)	r _ε (mm)	d ₁ (mm)	m (mm)	gatunki / grades											
									CVD					PVD			HW			
									NTP15	NTP25	NTP35	NTM25	NTM35	NTK05	NTK25	N325	N335	S10S	S20S	SM25T
	16	TNMG 160404-12	16,5	9,525	4,76	0,4	3,81	13,891	○	●										
		TNMG 160408-12	16,5	9,525	4,76	0,8	3,81	13,494		○	○									
	16	TNMG 160404-PC	16,5	9,525	4,76	0,4	3,81	13,891	○	○	●			●	●					
		TNMG 160408-PC	16,5	9,525	4,76	0,8	3,81	13,494	○	○	○			●	●					
	22	TNMG 160412-PC	16,5	9,525	4,76	1,2	3,81	13,097	○	○	○			●	●					
		TNMG 220408-PC	22	12,70	4,76	0,8	5,16	18,256	○	○	○			●	●					
		TNMG 220412-PC	22	12,70	4,76	1,2	5,16	17,859	○	○	○			●	●					
	16	TNMG 160404-SM	16,5	9,525	4,76	0,4	3,81	13,891		○										
		TNMG 160408-SM	16,5	9,525	4,76	0,8	3,81	13,494		○	●			●						
	TNMG 160412-SM	16,5	9,525	4,76	1,2	3,81	13,097			●			●							
	16	TNMG 160404-13	16,5	9,525	4,76	0,4	3,81	13,891		○	●									
		TNMG 160408-13	16,5	9,525	4,76	0,8	3,81	13,494		○	●									
	16	TNMM 160404-13	16,5	9,525	4,76	0,4	3,81	13,891			●									
		TNMM 160408-13	16,5	9,525	4,76	0,8	3,81	13,494		○	○									
	16	TNMG 160304	16,5	9,525	3,18	0,4	3,81	13,891			○									
		TNMG 160308	16,5	9,525	3,18	0,8	3,81	13,494			○									
		TNMG 160404	16,5	9,525	4,76	0,4	3,81	13,891	○	○	●			○	○	○	○	○	○	
		TNMG 160408	16,5	9,525	4,76	0,8	3,81	13,494			○			○	○	○	○	○	○	
		TNMG 160412	16,5	9,525	4,76	1,2	3,81	13,097			○			○	○	○	○	○	○	
		22	TNMG 220404	22	12,70	4,76	0,4	5,16	18,653			○			○	○	○	○	○	○
			TNMG 220408	22	12,70	4,76	0,8	5,16	18,256			○			○	○	○	○	○	○
			TNMG 220412	22	12,70	4,76	1,2	5,16	17,859			○			○	○	○	○	○	○
			TNMG 220416	22	12,70	4,76	1,6	5,16	17,463			○			○	○	○	○	○	○
	16	TNMM 160404	16,5	9,525	4,76	0,4	3,81	13,891		○	●						○	○	○	
		TNMM 160408	16,5	9,525	4,76	0,8	3,81	13,494			○						○	○	○	
	22	TNMM 160412	16,5	9,525	4,76	1,2	3,81	13,097			○									
		TNMM 220404	22	12,70	4,76	0,4	5,16	18,653			○									
		TNMM 220408	22	12,70	4,76	0,8	5,16	18,256			○									
		TNMM 220412	22	12,70	4,76	1,2	5,16	17,859			○									
TNMM 220416	22	12,70	4,76	1,6	5,16	17,463			○											
	16	TNMG 160408R	16,5	9,525	4,76	0,8	3,81	13,494		○	○	○		●		○				
		TNMG 160408L	16,5	9,525	4,76	0,8	3,81	13,494		○	●	○								
		TNMG 160412R	16,5	9,525	4,76	1,2	3,81	13,097		○	○									
		TNMG 160412L	16,5	9,525	4,76	1,2	3,81	13,097			○									
	16	TNMM 160408R	16,5	9,525	4,76	0,8	3,81	13,494		○	●									
		TNMM 160408L	16,5	9,525	4,76	0,8	3,81	13,494		○	○									
		TNMM 160412R	16,5	9,525	4,76	1,2	3,81	13,097		○	○									
		TNMM 160412L	16,5	9,525	4,76	1,2	3,81	13,097			○									

Przykład zamówienia / Ordering example: TNMG 160404-12, NTP25 – 10 szt. / pcs

CVD, PVD (HC) - gatunek pokrywany / coated grade

(HW) - gatunek niepokrywany / uncoated grade

● - pierwszy wybór / first choice

Płytki do toczenia

Inserts for turning

TNMA
TNMM
TNMG

TNMA

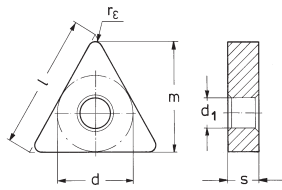

TNMM

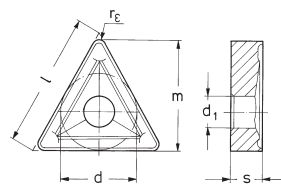

TNMG

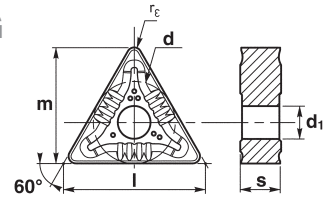

	Oznaczenie Designation	l (mm)	d (mm)	s (mm)	r _e (mm)	d ₁ (mm)	m (mm)	gatunki / grades														
								CVD						PVD			HW					
								NTP15	NTP25	NTP35	NTM25	NTM35	NTK05	NTK25	N325	N335	S10S	S20S	SM25T	S30S	H10S	H15X
	22 TNMG 220404-26 TNMG 220408-26 TNMG 220412-26 TNMG 220416-26	22	12,70	4,76	0,4	5,16	18,653		○	○												
	22 TNMM 220404-26 TNMM 220408-26 TNMM 220412-26 TNMM 220416-26	22	12,70	4,76	0,4	5,16	18,653		○	○												
	22 TNMM 220408-PD TNMM 220412-PD	22	12,70	4,76	0,8	5,16	18,256		○					●	●							
	22 TNMM 220412-53	22	12,70	4,76	1,2	5,16	17,859		●													
	22 TNMM 220412R TNMM 220412L	22	12,70	4,76	1,2	5,16	17,859		○	●	○											
	16 TNMG 160408-MB	16,5	9,525	4,76	0,8	3,81	13,494			○	○			●	●							
	16 22 TNMG 160408-MC TNMG 220408-MC TNMG 220412-MC	16,5	9,525	4,76	0,8	3,81	13,494			○	○			●	●	●						
	16 22 TNMA 160404 TNMA 160408 TNMA 160412 TNMA 220408 TNMA 220412 TNMA 220416	16,5	9,525	4,76	0,4	3,81	13,891							○	○					○	○	○
	16 22 TNMG 160408-KC TNMG 160412-KC TNMG 220408-KC TNMG 220412-KC	16,5	9,525	4,76	0,8	3,81	13,097			○	○											

Przykład zamówienia / Ordering example: TNMG 220404-26, NTP25 – 10 szt. / pcs

CVD, PVD (HC) - gatunek pokrywany / coated grade
(HW) - gatunek niepokrywany / uncoated grade

● - pierwszy wybór / first choice

VNMG

VNMG

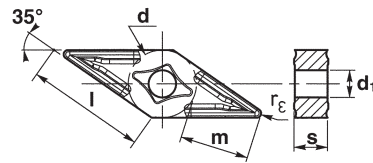

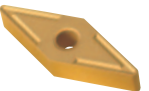
	Oznaczenie Designation	l (mm)	d (mm)	s (mm)	r ϵ (mm)	d ₁ (mm)	m (mm)	gatunki / grades														
								CVD						PVD			HW					
								NTP15	NTP25	NTP35	NTM25	NTM35	NTK05	NTK25	N325	N335	S10S	S20S	SM25T	S30S	H10S	H15X
	16 VNMG 160404-PC VNMG 160408-PC	16,5	9,525	4,76	0,4	3,81	10,152															
		16,5	9,525	4,76	0,8	3,81	9,229															
	16 VNMG 160408	16,5	9,525	4,76	0,8	3,81	9,229															

Przykład zamówienia / Ordering example: VNMG 160404-PC, NTP25 – 10 szt. / pcs

CVD, PVD (HC) - gatunek pokrywany / coated grade
 (HW) - gatunek niepokrywany / uncoated grade

● - pierwszy wybór / first choice

Płytki do toczenia

Inserts for turning

WNMA
WNMG

WNMA

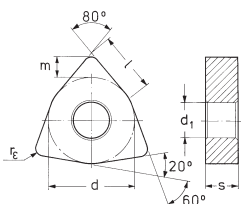

WNMG

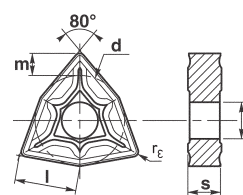

	Oznaczenie Designation	l (mm)	d (mm)	s (mm)	rε (mm)	d1 (mm)	m (mm)	gatunki / grades											
								CVD						PVD			HW		
								NTP15	NTP25	NTP35	NTM25	NTM35	NTK05	NTK25	N325	N335	S10S	S20S	SM25T
	06 WNMG 060404-PB 08 WNMG 060408-PB 08 WNMG 080404-PB 08 WNMG 080408-PB	6,5 6,5 8,7 8,7	9,525 9,525 12,70 12,70	4,76 4,76 4,76 4,76	0,4 0,8 0,4 0,8	3,81 3,81 5,16 5,16	2,426 2,205 3,308 3,088	○ ○ ○ ○					● ● ● ●						
	08 WNMG 080408-12	8,7	12,70	4,76	0,8	5,16	3,088	○ ○											
	06 WNMG 060404-PC 08 WNMG 060408-PC 08 WNMG 060412-PC 08 WNMG 080404-PC 08 WNMG 080408-PC 08 WNMG 080412-PC	6,5 6,5 6,5 8,7 8,7 8,7	9,525 9,525 9,525 12,70 12,70 12,70	4,76 4,76 4,76 4,76 4,76 4,76	0,4 0,8 1,2 0,4 0,8 1,2	3,81 3,81 3,81 5,16 5,16 5,16	2,426 2,205 1,985 3,308 3,088 2,867	○ ○ ○ ● ○ ○ ○ ○ ○ ○ ○ ○					● ● ● ● ● ○						
	08 WNMG 080408-SM 08 WNMG 080412-SM	8,7 8,7	12,70 12,70	4,76 4,76	0,8 1,2	5,16 5,16	3,088 2,867	○ ○ ○ ○					● ○						
	08 WNMG 080404-79 08 WNMG 080408-79 08 WNMG 080412-79	8,7 8,7 8,7	12,70 12,70 12,70	4,76 4,76 4,76	0,4 0,8 1,2	5,16 5,16 5,16	3,308 3,088 2,867	○ ○ ○ ○ ○ ○											
	08 WNMG 080408	8,7	12,70	4,76	0,8	5,16	3,088	○ ○				○						○	
	08 WNMG 080408-MB	8,7	12,70	4,76	0,8	5,16	3,088			○ ○			● ●						
	08 WNMG 080404-MC 08 WNMG 080408-MC	8,7 8,7	12,70 12,70	4,76 4,76	0,4 0,8	5,16 5,16	3,308 3,088			○ ○ ○ ○			● ● ● ●						
	08 WNMA 080408 08 WNMA 080412	8,7 8,7	12,70 12,70	4,76 4,76	0,8 1,2	5,16 5,16	3,088 2,867						○ ○ ○ ○					○	
	06 WNMG 060404-KC 08 WNMG 060408-KC 08 WNMG 080408-KC	6,5 6,5 8,7	9,525 9,525 12,70	4,76 4,76 4,76	0,4 0,8 0,8	3,81 3,81 5,16	2,426 2,205 3,088						○ ○ ○ ●						

Przykład zamówienia / Ordering example: WNMG 060404-PB, NTP25 – 10 szt. / pcs

CVD, PVD (HC) - gatunek pokrywany / coated grade
(HW) - gatunek niepokrywany / uncoated grade

● - pierwszy wybór / first choice

Płytki do toczenia

Inserts for turning

CCMT
DCMT
ECMT

CCMT

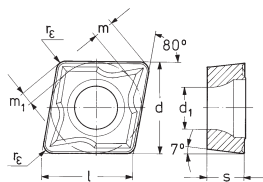

DCMT

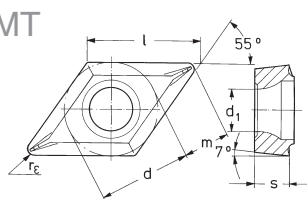

ECMT

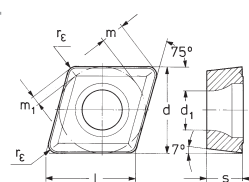

	Oznaczenie Designation	l (mm)	d (mm)	s (mm)	r _e (mm)	d ₁ (mm)	m (mm)	m ₁ (mm)	gatunki / grades													
									CVD						PVD		HW					
									NTP15	NTP25	NTP35	NTM25	NTM35	NTK05	NTK25	N325	N335	S10S	S20S	SM25T	S30S	H10S
	06 CCMT 060204-12	6,4	6,35	2,38	0,4	2,8	1,543	0,848	○	○	●											
	CCMT 060208-12	6,4	6,35	2,38	0,8	2,8	1,322	0,727	○	○	●											
	09 CCMT 09T304	9,7	9,525	3,97	0,4	4,4	2,424	1,333	○	○	●	○										○
	09 CCMT 09T308	9,7	9,525	3,97	0,8	4,4	2,206	1,212	○	○	●				○	○						○
	12 CCMT 120408-14	12,9	12,70	4,76	0,8	5,5	3,088	1,697		○	●										●	
	07 DCMT 070202-12	7,75	6,35	2,38	0,4	2,8	3,238			○	○											○
	DCMT 070204-12	7,75	6,35	2,38	0,4	2,8	3,238			○	○											○
	DCMT 070208-12	7,75	6,35	2,38	0,8	2,8	2,775			○	○											○
	11 DCMT 11T304-14	11,6	9,525	3,97	0,4	4,4	5,089			○	○											
	11 DCMT 11T304	11,6	9,525	3,97	0,4	4,4	5,089		○	○	●											○
	DCMT 11T308	11,6	9,525	3,97	0,8	4,4	4,626		○	○	●	○	○	○								○
	08 ECMT 080304	8,2	7,94	3,18	0,4	3,4	2,296	0,931		○	○											

Przykład zamówienia / Ordering example: CCMT 060202-12, NTP35 – 10 szt. / pcs

CVD, PVD (HC) - gatunek pokrywany / coated grade

(HW) - gatunek niepokrywany / uncoated grade

● - pierwszy wybór / first choice

Płytki do toczenia

Inserts for turning

TCMT
VBMT
VBMW
WCMT

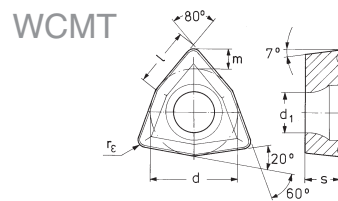
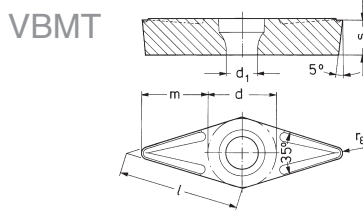
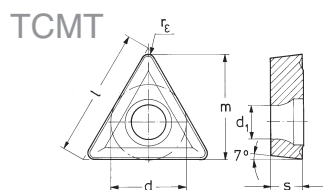

Image	Code	Oznaczenie Designation	l (mm)	d (mm)	s (mm)	r _e (mm)	d ₁ (mm)	m (mm)	gatunki / grades																
									CVD						PVD			HW							
									NTP15	NTP25	NTP35	NTM25	NTM35	NTK05	NTK25	N325	N335	S10S	S20S	SM25T	S30S	H10S	H15X	H20S	
	11	TCMT 110204	11,0	6,35	2,38	0,4	2,8	9,128	○	○	●	○													
	16	TCMT 16T308-11	16,5	9,525	3,97	0,8	4,4	13,494		○	○														
	16	TCMT 16T304	16,5	9,525	3,97	0,4	4,4	13,891	○	○	●											○	○		
		TCMT 16T308	16,5	9,525	3,97	0,8	4,4	13,494			○	○										○			
	22	TCMT 220408-11	22,0	12,70	4,76	0,8	5,5	18,256	○	○	●	○										●	○		
	16	VBMT 160404	16,6	9,525	4,76	0,4	4,4	9,755	○	○	●														
		VBMT 160408	16,6	9,525	4,76	0,8	4,4	9,229			○	○													
	16	VBMT 160408-MC	16,6	9,525	4,76	0,8	4,4	9,229				○	○			●									
	16	VBMW 160408	16,6	9,525	4,76	0,8	4,4	9,229																	
	16	VBMT 160408-23	16,6	9,525	4,76	0,8	4,4	9,229																	●
	05	WCMT 050308	5,43	7,94	3,18	0,8	4,0	1,765				○													
	06	WCMT 06T308	6,52	9,525	3,97	0,8	4,4	2,206				○													

Przykład zamówienia / Ordering example: TCMT 110204, NTP35 – 10 szt. / pcs

CVD, PVD (HC) - gatunek pokrywany / coated grade

(HW) - gatunek niepokrywany / uncoated grade

● - pierwszy wybór / first choice

Płytki do toczenia

Inserts for turning

do aluminium / for aluminium

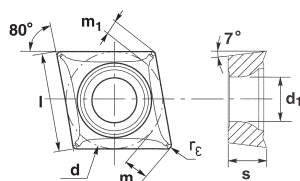

CCGT
DCGT
SCGT
TCGT
VCGT

CCGT

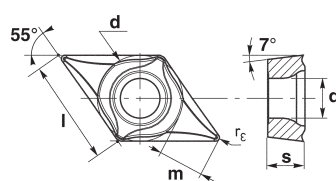

DCGT

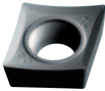
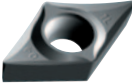
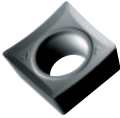

		Oznaczenie Designation	l (mm)	d (mm)	s (mm)	r ϵ (mm)	d ₁ (mm)	m (mm)	m ₁ (mm)	PVD
										KX20
	06	CCGT 060202-1L	6,49	6,40	2,58	0,2	2,8	1,668	0,917	●
		CCGT 060204-1L	6,49	6,40	2,58	0,4	2,8	1,557	0,856	●
	08	CCGT 080302-1L	8,12	8,00	3,43	0,2	3,4	2,113	1,161	●
		CCGT 080304-1L	8,12	8,00	3,43	0,4	3,4	2,003	1,101	●
	09	CCGT 09T304-1L	9,73	9,586	4,22	0,4	4,4	2,443	1,343	●
		CCGT 09T308-1L	9,73	9,586	4,22	0,8	4,4	2,222	1,221	●
	12	CCGT 120408-1L	12,96	12,76	5,01	0,8	5,5	3,105	1,706	●
	07	DCGT 070204-1L	7,78	6,399	2,58	0,4	2,9	3,267		●
	11	DCGT 11T302-1L	11,7	9,586	4,22	0,2	4,4	5,357		●
		DCGT 11T304-1L	11,7	9,586	4,22	0,4	4,4	5,125		●
		DCGT 11T308-1L	11,7	9,586	4,22	0,8	4,4	4,662		●
	09	SCGT 09T304-1L	9,586	9,586	4,22	0,4	4,4	1,821		●
		SCGT 09T308-1L	9,586	9,586	4,22	0,8	4,4	1,657		●
	11	TCGT 110202-1L	11,084	6,40	2,58	0,2	2,8	9,401		●
		TCGT 110204-1L	11,084	6,40	2,58	0,4	2,8	9,202		●
	16	TCGT 16T304-1L	16,604	9,586	4,22	0,4	4,4	13,983		●
		TCGT 16T308-1L	16,604	9,586	4,22	0,8	4,4	13,586		●
	11	VCGT 110202-1L	11,157	6,399	2,58	0,2	2,8	6,98		●
		VCGT 110204-1L	11,157	6,399	2,58	0,4	2,8	6,517		●
	13	VCGT 130302-1L	13,99	8,001	3,43	0,2	3,4	8,843		●
		VCGT 130304-1L	13,99	8,001	3,43	0,4	3,4	8,38		●
		VCGT 130308-1L	13,99	8,001	3,43	0,8	3,4	6,902		●
	16	VCGT 160404-1L	16,713	9,586	5,01	0,4	4,4	10,223		●
		VCGT 160408-1L	16,713	9,586	5,01	0,8	4,4	9,3		●

Przykład zamówienia / Ordering example: CCGT 060202-1L, KX20 – 10 szt. / pcs

CVD, PVD (HC) - gatunek pokrywany / coated grade
(HW) - gatunek niepokrywany / uncoated grade

● - pierwszy wybór / first choice

Płytki do toczenia

Inserts for turning

**SNGN
SNUN
SPGN
SPUN**

SNGN
SNUN

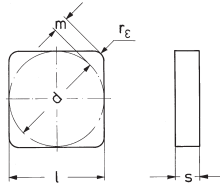

SPGN
SPUN

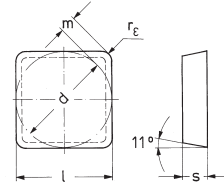

	Oznaczenie Designation	l=d (mm)	s (mm)	rε (mm)	m (mm)	gatunki / grades															
						CVD					PVD			HW							
						NTP15	NTP25	NTP35	NTM25	NTM35	NTK05	NTK25	N325	N335	S10S	S20S	SM25T	S30S	H10S	H15X	H20S
	12 SNGN 120408	12,70	4,76	0,8	2,301														○		
	SNGN 120412	12,70	4,76	1,2	2,137														○		
	09 SNUN 090308	9,525	3,18	0,8	1,644		●														
	12 SNUN 120308	12,70	3,18	0,8	2,301		○														
	SNUN 120408	12,70	4,76	0,8	2,301		●				○				○	●			○		
	SNUN 120412	12,70	4,76	1,2	2,137		●			○				○	○				○		
	SNUN 120416	12,70	4,76	1,6	1,973		●			○				○	○					○	
	15 SNUN 150408	15,875	4,76	0,8	2,959		●							○							
	SNUN 150412	15,875	4,76	1,2	2,795		●							○							○
	19 SNUN 190408	19,05	4,76	0,8	3,617		○				○				○	○					○
	SNUN 190412	19,05	4,76	1,2	3,452		●			○				○	○						
	SNUN 190416	19,05	4,76	1,6	3,288		○				○			○	○						
25 SNUN 250620	25,40	6,35	2,0	4,437		○							○	○							
SNUN 250620T ¹⁾	25,40	6,35	2,0	4,437		○							○	○		●					
	09 SPGN 090304	9,525	3,18	0,4	1,808														○		
	12 SPGN 090308	9,525	3,18	0,8	1,644														○		
	SPGN 120304	12,70	3,18	0,4	2,466														○	○	
	SPGN 120308	12,70	3,18	0,8	2,301		○													○	○
	SPGN 120312	12,70	3,18	1,2	2,137																○
	SPGN 120320	12,70	3,18	2,0	1,802																○
	SPGN 120408	12,70	4,76	0,8	2,301																○
	19 SPGN 190408	19,05	4,76	0,8	3,617																○
	SPGN 190412	19,05	4,76	1,2	3,452																○
	09 SPUN 090304	9,525	3,18	0,4	1,808		○	○												○	
	SPUN 090308	9,525	3,18	0,8	1,644		○	●												○	
	12 SPUN 120304	12,70	3,18	0,4	2,466		○	○		○	●									○	
	SPUN 120308	12,70	3,18	0,8	2,301		○	○	○		○	●								○	
	SPUN 120312	12,70	3,18	1,2	2,137		○	○	○		○	○								○	
	SPUN 120316	12,70	3,18	1,6	1,973		○	○	○		○	○								○	
	SPUN 150412	15,875	4,76	1,2	2,795		○	○												○	
	19 SPUN 190408	19,05	4,76	0,8	3,617		○	○	○		○	○								○	
	SPUN 190412	19,05	4,76	1,2	3,452		○	○	○		○	○								○	
	SPUN 190416	19,05	4,76	1,6	3,288		○	○	○		○	○								○	
25 SPUN 250620	25,40	6,35	2,0	4,437		○	○	○		○	○								○		
SPUN 250620T ¹⁾	25,40	6,35	2,0	4,437		○	○	○		○	○								○		

Krawędź ze ścinem. / Chamfered edge

¹⁾ T = 0,45 x 20°

Przykład zamówienia / Ordering example: SNGN 120408, S20S – 10 szt. / pcs

CVD, PVD (HC) - gatunek pokrywany / coated grade

(HW) - gatunek niepokrywany / uncoated grade

● - pierwszy wybór / first choice

Płytki do toczenia

Inserts for turning



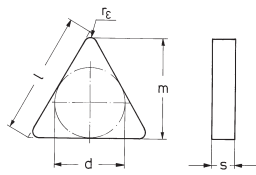

TNGN
TNUN
TPGN
TPUN

TNGN
TNUN

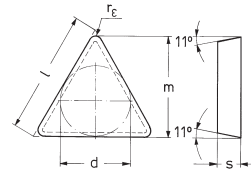

TPGN
TPUN



		Oznaczenie Designation	l (mm)	d (mm)	s (mm)	r _e (mm)	m (mm)	gatunki / grades															
								CVD			PVD		HW										
								NTP15	NTP25	NTP35	NTM25	NTM35	NTK05	NTK25	N325	N335	S10S	S20S	SM25T	S30S	H10S	H15X	H20S
	16	TNGN 160408	16,5	9,525	4,76	0,8	13,494																
	22	TNGN 160412	16,5	9,525	4,76	1,2	13,097															○	
	33	TNGN 220412	22	12,70	4,76	1,2	17,859													○			
		TNGN 330620	33	19,05	6,35	2,0	26,591																
	11	TNUN 110304	11	6,35	3,18	0,4	9,128													○			
	16	TNUN 110308	11	6,35	3,18	0,8	8,731													○			
		TNUN 160404	16,5	9,525	4,76	0,4	13,891	○															
		TNUN 160408	16,5	9,525	4,76	0,8	13,494		○											●			
		TNUN 160412	16,5	9,525	4,76	1,2	13,097			○										●			○
		TNUN 160416	16,5	9,525	4,76	1,2	13,097			○										○		●	
	22	TNUN 220408	22	12,70	4,76	0,8	18,256			○										○			
		TNUN 220412	22	12,70	4,76	1,2	17,859			○										○		○	
		TNUN 220416	22	12,70	4,76	1,6	17,463			○										○		○	
		TNUN 330620T ¹⁾	33	19,05	6,35	2,0	26,591													○			
	11	TPGN 110204	11	6,35	2,38	0,4	9,128			●				○					○	●		○	○
		TPGN 110208	11	6,35	2,38	0,8	8,731			○										○	●		
		TPGN 110302	11	6,35	3,18	0,2	9,325																
		TPGN 110304	11	6,35	3,18	0,4	9,128			○													
		TPGN 110308	11	6,35	3,18	0,8	8,731			○													
	16	TPGN 160302	16,5	9,525	3,18	0,2	14,088			○										○	●		○
		TPGN 160304	16,5	9,525	3,18	0,4	13,891	○													○	●	
		TPGN 160308	16,5	9,525	3,18	0,8	13,494		○											○	●		○
	22	TPGN 220404	22	12,70	4,76	0,4	18,653			○													
		TPGN 220408	22	12,70	4,76	0,8	18,256			○													
		TPGN 220412	22	12,70	4,76	1,2	17,859			○													
		TPGN 220430	22	12,70	4,76	3,0	16,050														○	●	
	11	TPUN 110208	11	6,35	3,18	0,8	8,731			○													
		TPUN 110302	11	6,35	3,18	0,2	9,325																
		TPUN 110304	11	6,35	3,18	0,4	9,128	○		○	○									○	○		○
		TPUN 110308	11	6,35	3,18	0,8	8,731			○										○	○		○
	16	TPUN 160304	16,5	9,525	3,18	0,4	13,891	○		○													
		TPUN 160308	16,5	9,525	3,18	0,8	13,494			○													
		TPUN 160312	16,5	9,525	3,18	1,2	13,097	○		○													
		TPUN 160316	16,5	9,525	3,18	1,6	12,700			○													
	22	TPUN 220404	22	12,70	4,76	0,4	18,653			○										○			
		TPUN 220408	22	12,70	4,76	0,8	18,256			○													
		TPUN 220412	22	12,70	4,76	1,2	17,859			○													
		TPUN 220416	22	12,70	4,76	1,6	17,463			○													
	33	TPUN 330620	33	19,05	6,35	2,0	26,591			○													
		TPUN 330620T ¹⁾	33	19,05	6,35	2,0	26,591			●													●

Krawędź ze ściem. / Chamfered edge

¹⁾ T = 0,45 x 20°

Przykład zamówienia / Ordering example: TNGN 160408, H10S – 10 szt. / pcs

CVD, PVD (HC) - gatunek pokrywany / coated grade
(HW) - gatunek niepokrywany / uncoated grade

● - pierwszy wybór / first choice

Inserts for turning

KNUX
SPMR
TPMR

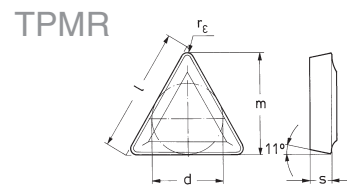
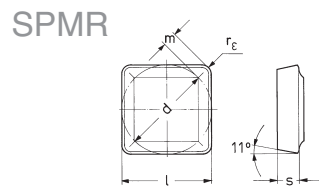
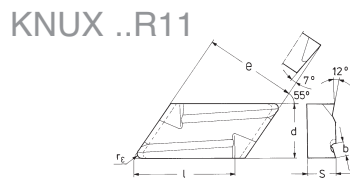

	Oznaczenie Designation	l (mm)	d (mm)	s (mm)	r _e (mm)	e (mm)	b (mm)	gatunki / grades																							
								CVD						PVD			HW														
								NTP15	NTP25	NTP35	NTM25	NTM35	NTK05	NTK25	N325	N335	S10S	S20S	SM25T	S30S	H10S	H15X	H20S								
	16 KNUX 160405 R11	16	9,525	4,76	0,5	16,15	3,2	○	○	●		○				○															
	Oznaczenie Designation	l=d (mm)	s (mm)	r _e (mm)	m (mm)																										
	09 SPMR 090304	9,525	3,18	0,4	1,808			○																							
	SPMR 090308	9,525	3,18	0,8	1,644			○																							
	12 SPMR 120304	12,70	3,18	0,4	2,466			○																							
	SPMR 120308	12,70	3,18	0,8	2,301			○	●																						
	SPMR 120312	12,70	3,18	1,2	2,137				○				●																		
	Oznaczenie Designation	l (mm)	d (mm)	s (mm)	r _e (mm)	m (mm)																									
	11 TPMPR 110304	11	6,35	3,18	0,4	9,128		○	○	○						○															
	TPMPR 110308	11	6,35	3,18	0,8	8,731										○															
	16 TPMPR 160304	16,5	9,525	3,18	0,4	13,891			○	●						○								○							
	TPMPR 160308	16,5	9,525	3,18	0,8	13,494			○	●						○															

Przykład zamówienia / Ordering example: KNUX 160405 R11, NTP35 – 10 szt. / pcs

CVD, PVD (HC) - gatunek pokrywany / coated grade
(HW) - gatunek niepokrywany / uncoated grade

● - pierwszy wybór / first choice

Płytki do toczenia

Inserts for turning



LNUX TNMR

LNUX

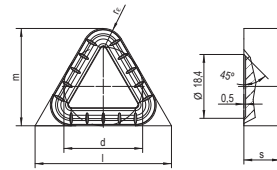
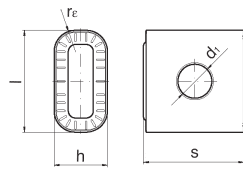
TNMR



do zestawów kołowych

	Oznaczenie Designation	l (mm)	s (mm)	h (mm)	rε (mm)	d ₁ (mm)	gatunki / grades												
							CVD						PVD		HW				
							NTP15	NTP25	NTP35	NTM25	NTM35	NTK05	NTK25	N325	N335	S10S	S20S	SM25T	S30S
	19 30 LNUX 191940 LNUX 301940	19,05 30	18,85 19,05	10 12	4,0 4,0	6,35 6,35	●	●	○										
	Oznaczenie Designation	l (mm)	d (mm)	s (mm)	rε (mm)	d ₁ (mm)	m (mm)												
	40 TNMR 401060	39,3	22,7	10,5	6,0	-	28,5											●	

Przykład zamówienia / Ordering example: LNUX 191940, NTP25 – 10 szt. / pcs

CVD, PVD (HC) - gatunek pokrywany / coated grade
 (HW) - gatunek niepokrywany / uncoated grade

● - pierwszy wybór / first choice

Płytki do toczenia

Inserts for turning

**TNMX
XNMX**

TNMX

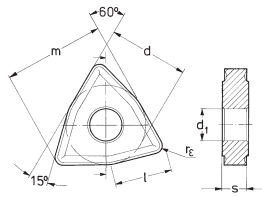

XNMX

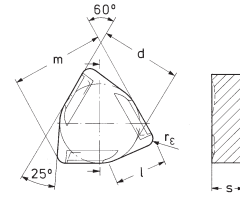

do łuszczenia prętów

	Oznaczenie Designation	l (mm)	d (mm)	s (mm)	r _e (mm)	d ₁ (mm)	m (mm)	gatunki / grades													
								CVD					PVD		HW						
								NTP15	NTP25	NTP35	NTM25	NTM35	NTK05	NTK25	N325	N335	S10S	S20S	SM25T	S30S	H10S
	15 TNMX 150916	16,5	22,225	9,52	1,6	7,93	28,21	○	○												
	28 XNMX 281012	14,8	22,0	10,0	1,2	-	26,36		○					○							

Przykład zamówienia / Ordering example: TNMX 150916, NTP25 – 10 szt. / pcs

CVD, PVD (HC) - gatunek pokrywany / coated grade
 (HW) - gatunek niepokrywany / uncoated grade

● - pierwszy wybór / first choice

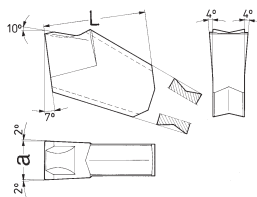

LFMX
150.15

LFMX ..N

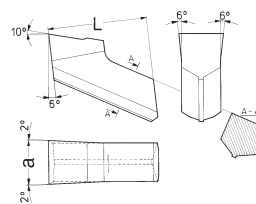

150.15

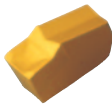

	Oznaczenie Designation	a (mm)	L (mm)	gatunki / grades													
				CVD						PVD		HW					
				NTP15	NTP25	NTP35	NTM25	NTM35	NTK05	NTK25	N435	S10S	S20S	SM25T	S30S	H10S	H15X
	2 LFMX 2R 3 LFMX 3N 4 LFMX 4N 5 LFMX 5N	2,2 3,1 4,1 5,1	9,0 11,0 11,0 11,0							●							
	3 150.15 - 9030 4 150.15 - 9040 5 150.15 - 9050	3,0 4,0 5,0	9,0 9,0 9,0			○				○			●				

Przykład zamówienia / Ordering example: LFMX 2R, N435 – 10 szt. / pcs

CVD, PVD (HC) - gatunek pokrywany / coated grade
(HW) - gatunek niepokrywany / uncoated grade

● - pierwszy wybór / first choice

Płytki do rowkowania X61..

Inserts for grooving X61..

X61

X61 0602-...R
X61 09T3-...R

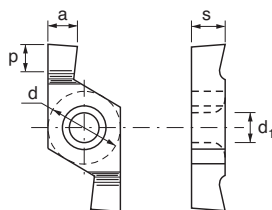

X61 0602-R...R
X61 09T3-R...R

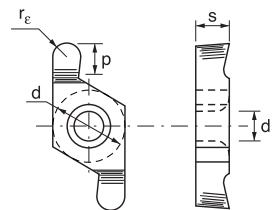

	Oznaczenie Designation	d (mm)	s (mm)	d ₁ (mm)	a (mm)	p (mm)	gatunki			
							CVD	PVD	HW	
							5735	5820	SY3	
	06 X61 0602-110 R	6,35	2,38	2,8	1,10	1,2	●	●		
	X61 0602-110 L	6,35	2,38	2,8	1,10	1,2	●	●		
	X61 0602-130 R	6,35	2,38	2,8	1,30	1,2	●	●		
	X61 0602-130 L	6,35	2,38	2,8	1,30	1,2	●	●		
	X61 0602-160 R	6,35	2,38	2,8	1,60	1,2	●	●		
	X61 0602-160 L	6,35	2,38	2,8	1,60	1,2	●	●		
	X61 0602-185 R	6,35	2,38	2,8	1,85	1,2	●	●		
	X61 0602-185 L	6,35	2,38	2,8	1,85	1,2	●	●		
	X61 0602-215 R	6,35	2,38	2,8	2,15	1,2	●	●		
	X61 0602-215 L	6,35	2,38	2,8	2,15	1,2	●	●		
	X61 0602-265 R	6,35	2,38	2,8	2,65	1,2	●	●		
	X61 0602-265 L	6,35	2,38	2,8	2,65	1,2	●	●		
	X61 0602-300 R	6,35	2,38	2,8	3,00	1,2	●	●		
	X61 0602-300 L	6,35	2,38	2,8	3,00	1,2	●	●		
	X61 0602-315 R	6,35	2,38	2,8	3,15	1,2	●	●		
	X61 0602-315 L	6,35	2,38	2,8	3,15	1,2	●	●		
	09	X61 09T3-415 R	9,525	3,97	3,8	4,15	5,5			●
		X61 09T3-415 L	9,525	3,97	3,8	4,15	5,5			●
X61 09T3-515 R		9,525	3,97	3,8	5,15	5,5			●	
	Oznaczenie Designation	d (mm)	s (mm)	d ₁ (mm)	r _e (mm)	p (mm)				
	06 X61 0602-R100 R	6,35	2,38	2,8	1,00	3,0	●	●		
	X61 0602-R100 L	6,35	2,38	2,8	1,00	3,0	●	●		
	X61 0602-R150 R	6,35	2,38	2,8	1,50	3,0	●	●		
	X61 0602-R150 L	6,35	2,38	2,8	1,50	3,0	●	●		
	09 X61 09T3-R250 L	9,525	3,97	3,8	2,50	5,5			●	

Przykład zamówienia / Ordering example: X61 0602-110 R, OR740 – 10 szt. / pcs

CVD, PVD (HC) - gatunek pokrywany / coated grade
(HW) - gatunek niepokrywany / uncoated grade

● - pierwszy wybór / first choice

X92

X92 ...-N

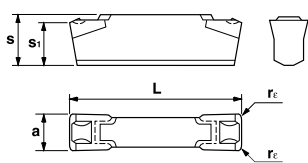

X92 ...-R

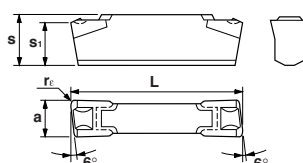

X92 ...-L

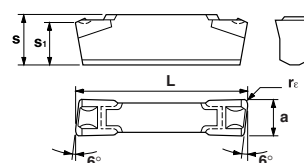

X92 ...-S

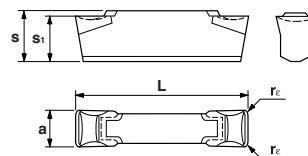

X92 ...-MS...

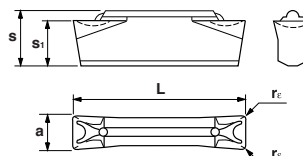

X92 ...-VS

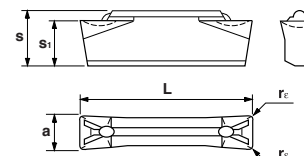

	Oznaczenie Designation	L (mm)	a (mm)	r _e (mm)	s (mm)	s ₁ (mm)	gatunki		
							PVD	HW	
	3 X92 200-30-V-N 4 X92 200-40-V-N 5 X92 250-50-V-N	20 20 25	3 4 5	0,1 0,2 0,2	4,3 5,3 6,3	4 5 6	5820	OR740	S4
	3 X92 200-30-V-R X92 200-30-V-L 4 X92 200-40-V-R X92 200-40-V-L	20 20 20 20	3 3 4 4	0,1 0,1 0,2 0,2	4,3 4,3 5,3 5,3	4 4 5 5			
	3 X92 200-30-V-S 4 X92 200-40-V-S 5 X92 250-50-V-S	20 20 25	3 4 5	0,1 0,2 0,2	4,3 5,3 6,3	4 5 6			
	3 X92 200-30-V-MS02 4 X92 200-40-V-MS02 5 X92 250-50-V-MS04	20 20 25	3 4 5	0,2 0,4 0,4	- 5,7 6,6	4 5 6			
	3 X92 200-30-V-VS 4 X92 200-40-V-VS 5 X92 250-50-V-VS	20 20 25	3 4 5	0,2 0,2 0,2	- 5,7 6,6	4 5 6			

Asortyment dostępny na zapytanie specjalne.
Available on special request.

Przykład zamówienia / Ordering example: X92 200-30-V-N, S4 – 10 szt. / pcs

CVD, PVD (HC) - gatunek pokrywany / coated grade
(HW) - gatunek niepokrywany / uncoated grade

● - pierwszy wybór / first choice

X92

X92 ...-20N

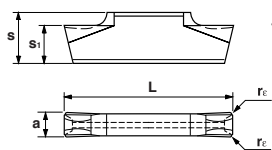

X92 ...-20R

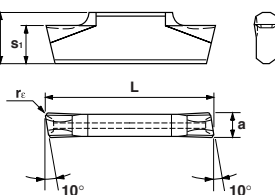

X92 ...-20L

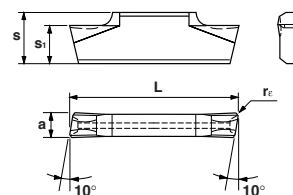



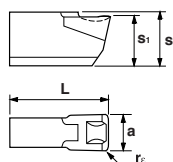

X92 ...-30N

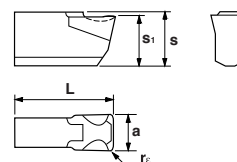

X92 ...-30S



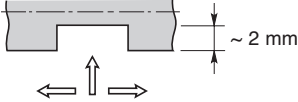







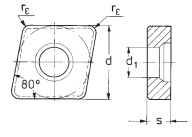

	Oznaczenie Designation	L (mm)	a (mm)	rε (mm)	s (mm)	s1 (mm)	gatunki		
							PVD	HW	
							5820	OR740	S4
	2 X92 140-20-V-N	14	2	0,2	4,2	3,1			
	2 X92 140-20-V-R X92 140-20-V-L	14 14	2 2	0,2 0,2	4,2 4,2	3,1 3,1			
	3 X92 95-30-V-N X92 120-30-V-N	9,5 12	3 3	0,2 0,2	4,3 4,3	4 4			
	3 X92 95-30-V-S	9,5	3	0,2	4,3	4			
									

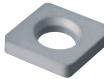
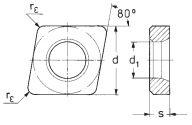
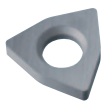
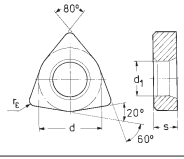
Asortyment dostępny na zapytanie specjalne.
Available on special request.

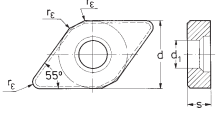
Przykład zamówienia / Ordering example: X92 140-20-V-N, OR740 – 10 szt. / pcs

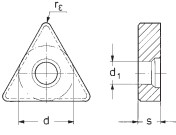
CVD, PVD (HC) - gatunek pokrywany / coated grade
(HW) - gatunek niepokrywany / uncoated grade

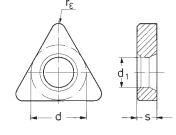
● - pierwszy wybór / first choice

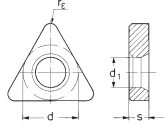
Płytki podporowe Shims		d (mm)	s (mm)	r _e (mm)	d ₁ (mm)	Długość boku płytki Insert edge length		
	123.26-622	12,30	4,76	1,20	6,20		12,9	
	123.26-628	18,60	6,35	1,60	8,30		19,3	
	123.24-721	12,50	3,18	1,20	6,40		12,9	CNMA CNMM CNMG
	454.64-721	12,50	3,18	0,80	6,40		8,7	WNMA WNMG
	171.66-624	12,30	4,76	1,20	6,20		15,5	
	171.64-721	12,50	3,18	1,20	6,40		15,5	
	117.26-621	9,52	3,18	1,20	5,20		16,5	
	117.26-622	9,52	4,76	1,20	5,20		16,5	
	170.26-624	12,30	4,76	1,20	6,20		22	TNMA TNMM TNMG
	117.26-719	9,30	2,80	1,20	4,85		16,5	

Części zamienne dobierać indywidualnie wg. zaleceń producenta narzędzi.

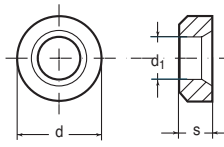

Przykład zamówienia / Ordering example: 123.26-622, B2 – 10 szt. / pcs
gatunek B2 / grade B2

	Płytki podporowe Shims	d (mm)	s (mm)	r _e (mm)	d ₁ (mm)		Długość boku płytki Insert edge length	
	111.26-622	12,70	4,76	1,20	6,20		12,7	 SNMA SNMM SNMG
	111.26.628	19,05	6,35	1,60	8,30		19,05	
	111.26-629	24,60	7,94	2,0	10,30		25,4	
	111.24-721	12,50	3,18	1,20	6,40		12,7	
	170.36-624	12,30	6,35	1,20	6,20		24,4	TNMX
	172.00-721	12,3	3,18	-	6,40		12,7	RNMG
	176.00-854	22,0	6,35	-	9,60		25,0	RCMX
	123.22-621	11,0	3,18	0,60	7,40		12,9	CCMT
	111.22-621	11,0	3,18	0,60	7,40		12,7	SCMT

Części zamienne dobierać indywidualnie wg. zaleceń producenta narzędzi.

Płytki podporowe i łamacze wióra

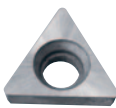
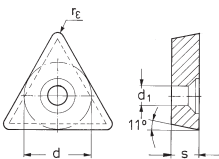
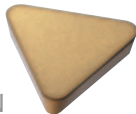
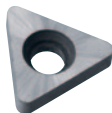
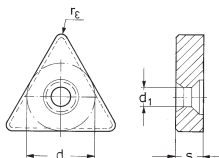

Shims and chipbreakers

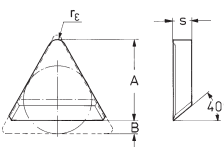
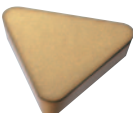
Płytki podporowe Shims		d (mm)	s (mm)	r _ε (mm)	d ₁ (mm)	Długość boku płytki Insert edge length		
	175.11-621	8,30	3,18	0,60	4,20		16,5	
	175.11-624	10,85	3,18	0,60	4,20		22,0	
	175.11-629	16,58	6,35	1,20	6,50		33,0	
	175.10-621	9,52	3,18	1,20	4,20		16,5	
	175.10-622		4,76				16,5	
	175.10-624	12,70	4,76	1,20	4,20		22,0	
	175.10-629	19,05	6,35	2,0	6,50		33,0	

Łamacze wióra Chipbreakers		B (mm)	A (mm)	s (mm)	r _ε (mm)	Długość boku płytki Insert edge length		
	PT 200	0,2	8,7	2,0	0,80		11,0	
	PT 212	1,2	7,5	2,0	0,80		11,0	
	PT 220	2,0	6,7	2,0	0,80		11,0	
	PT 300	0,2	13,5	2,5	0,80		16,5	
	PT 312	1,2	12,3	2,5	0,80		16,5	
	PT 320	2,0	11,5	2,5	0,80		16,5	
	PT 330	3,0	10,5	2,5	0,80		16,5	
	PT 345	4,5	9,0	2,5	0,80		16,5	
	PT 400	0,2	17,8	2,5	1,20		22,0	
	PT 420	2,0	15,8	2,5	1,20		22,0	
	PT 430	3,0	14,8	2,5	1,20		22,0	
	PT 445	4,5	13,3	2,5	1,20		22,0	
	PT 460	6,0	11,8	2,5	1,20		22,0	
	PT 600	0,2	27,0	4,0	1,60		33,0	
	PT 660	6,0	21,0	4,0	1,60		33,0	
	PT 690	9,0	18,0	4,0	1,60		33,0	

Części zamienne dobierać indywidualnie wg. zaleceń producenta narzędzi.

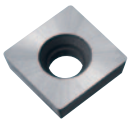
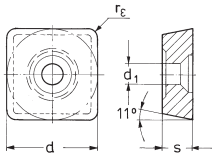
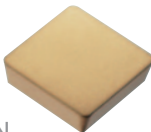
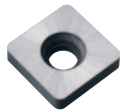
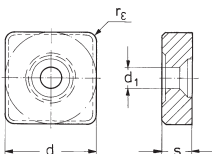
Przykład zamówienia / Ordering example: 175.11-621, B2 – 10 szt. / pcs
gatunek B2 / grade B2

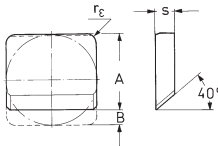
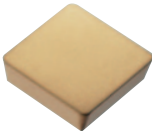
Płytki podporowe Shims		d (mm)	s (mm)	r _e (mm)	d ₁ (mm)	Długość boku płytki Insert edge length		
	174.11-621	11,46	3,18	0,60	4,20		12,70	 SPGN SPUN
	174.11-628	17,20	4,76	0,60	4,20		19,05	
	174.11-629	22,96	6,35	0,80	6,50		25,40	
	174.10-621	12,70	3,18	1,20	4,20		12,70	 SNGN SNUN
	174.10-622		4,76				12,70	
	174.10-628	19,05	4,76	1,20	4,20		19,05	
	174.10-629	25,40	9,52	2,0	6,50		25,40	
Łamacze wióra Chipbreakers		B (mm)	A (mm)	s (mm)	r _e (mm)	Długość boku płytki Insert edge length		
	PK 300	0,2	9,5	2,0	0,80		9,52	 SPGN SPUN
	PK 312	1,2	8,3	2,0	0,80		9,52	
	PK 320	2,0	7,5	2,0	0,80		9,52	
	PK 400	0,2	12,7	2,5	0,80		12,70	
	PK 412	1,2	11,5	2,5	0,80		12,70	
	PK 420	2,0	10,7	2,5	0,80		12,70	
	PK 430	3,0	9,7	2,5	0,80		12,70	
	PK 445	4,5	8,2	2,5	0,80		12,70	
	PK 460	6,0	6,7	2,5	0,80		12,70	
	PK 600	0,2	19,05	2,5	1,20		19,05	
	PK 620	2,0	17,05	2,5	1,20		19,05	
	PK 630	3,0	16,05	2,5	1,20		19,05	
	PK 645	4,5	14,55	2,5	1,20		19,05	
	PK 660	6,0	13,05	2,5	1,20		19,05	
	PK 690	9,0	10,05	2,5	1,20		19,05	
	PK 800	0,2	24,0	4,0	1,60		25,40	
	PK 860	6,0	18,0	4,0	1,60		25,40	
	PK 890	9,0	15,0	4,0	1,60		25,40	
	PK 8120	12,0	12,0	4,0	1,60		25,40	

Części zamienne dobierać indywidualnie wg. zaleceń producenta narzędzi.

Przykład zamówienia / Ordering example: 174.11-621, B2 – 10 szt. / pcs
gatunek B2 / grade B2



NARZĘDZIA DO TOCZENIA

TOOLS FOR TURNING

str. / page: rozdział / chapter:

D2	Oznaczenie noży do toczenia zewnętrznego <i>Designation of tools for external turning</i>
D3	Oznaczenie noży do toczenia wewnętrznego <i>Designation of tools for internal turning</i>
D4	Noże do toczenia zewnętrznego <i>Toolholders for external turning</i>
D16	Noże do toczenia wewnętrznego <i>Toolholders for internal turning</i>
D22	Przecinaki listwowe XLCFN.. <i>Parting blades XLCFN..</i>
D23	Noże do rowkowania P61.. <i>Toolholders for grooving P61..</i>
D24	Noże do rowkowania z roztaczaniem P92.. <i>Toolholders for grooving and recessing P92..</i>



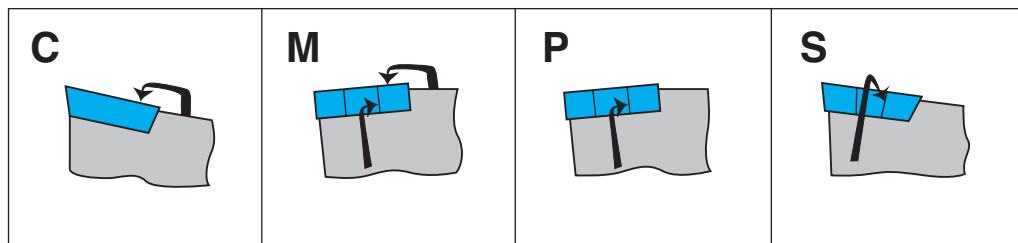
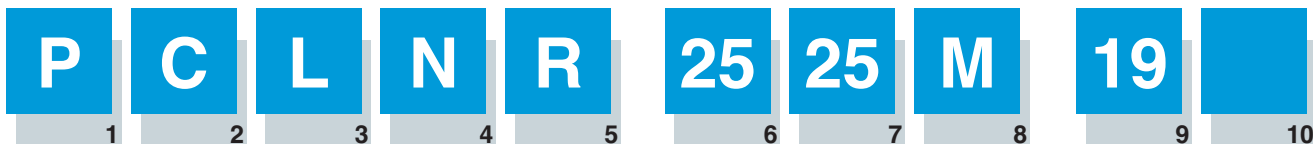

System mocowania / Clamping system 1

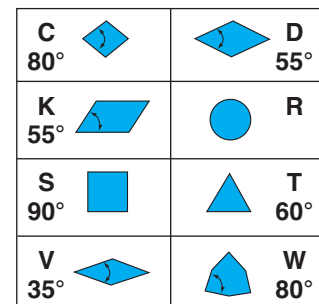

Kształt płytki 2
Insert shape

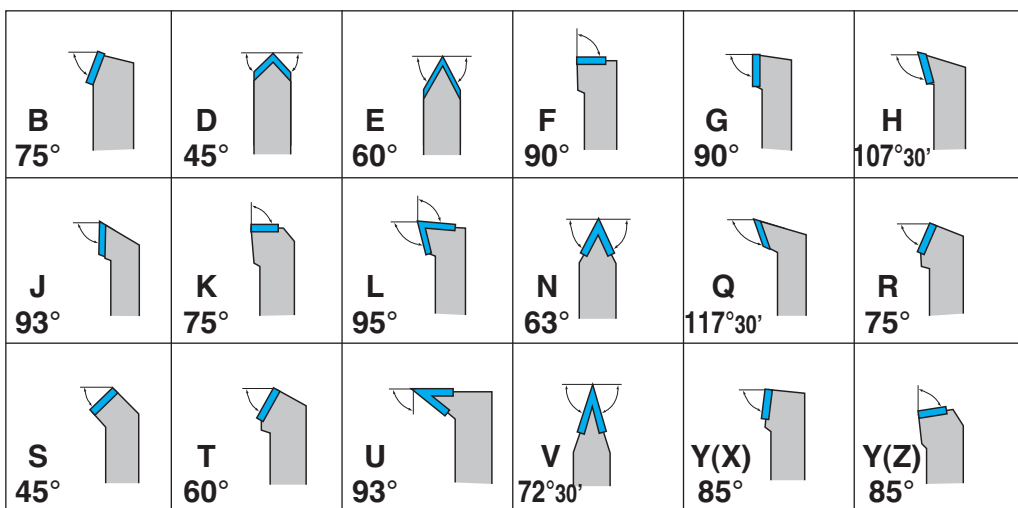

Rodzaj noża / Toolholder type 3

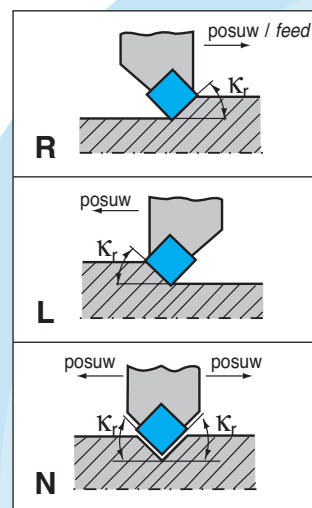

Kierunek skrawania 5
Cutting direction

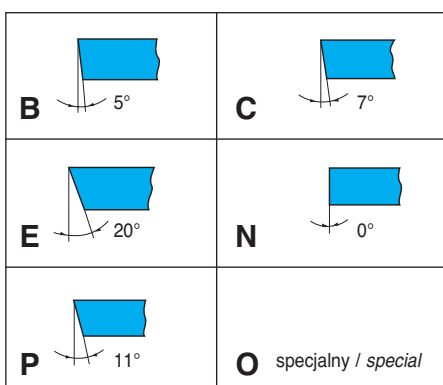

Kąt przyłożenia α_n 4
Normal clearance angle

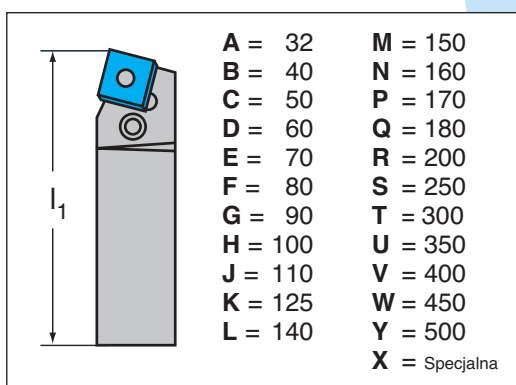

Długość noża / Toolholder length 8

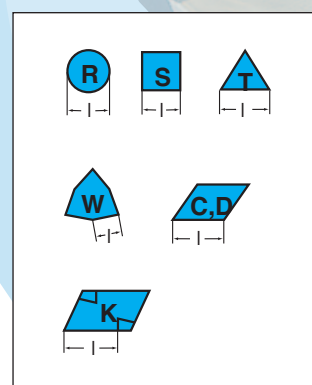

Długość boku płytki 9
Edge length

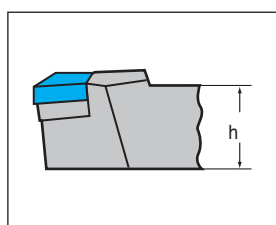

Wysokość noża 6
Toolholder height

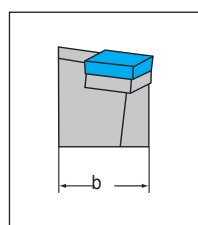

Szerokość noża 7
Toolholder width

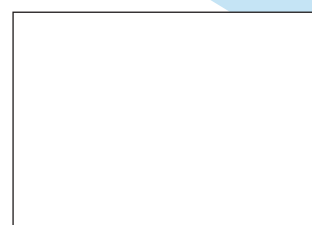

Informacja dodatkowa 10
Additional information

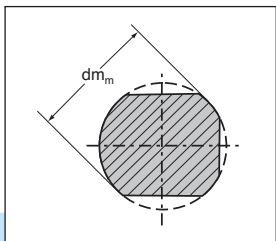

Średnica trzonu 2
Shank diameter

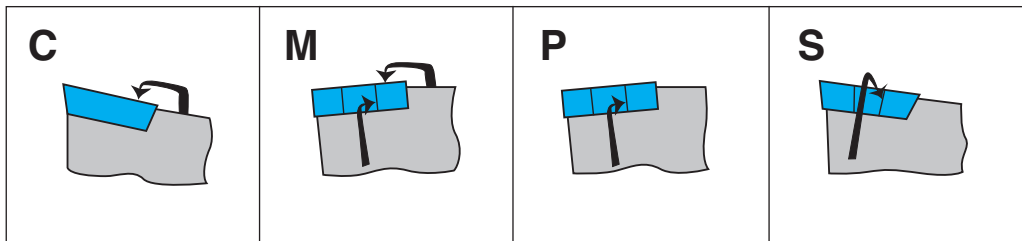

System mocowania / Clamping system 4

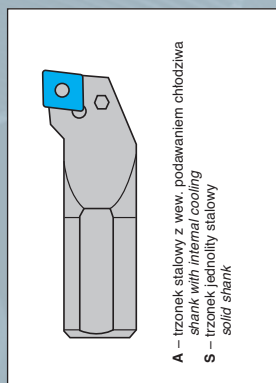

Wykonanie trzonu 1
Shank type

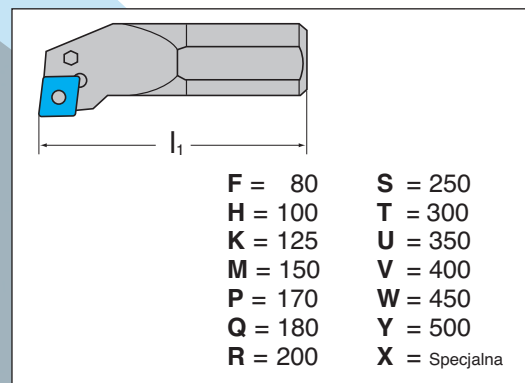

Długość noża / Toolholder length 3

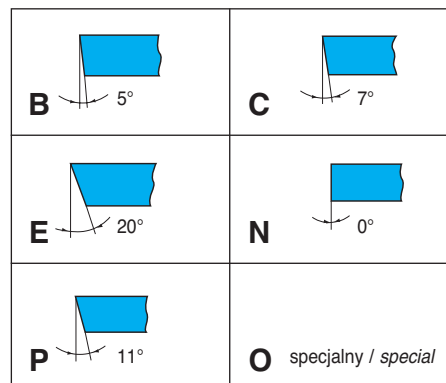

Kąt przyłożenia α_n 7
Normal clearance angle

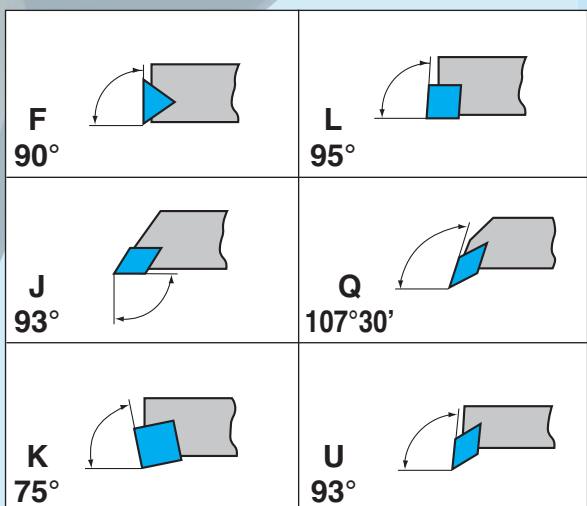

Rodzaj noża / Toolholder type 6

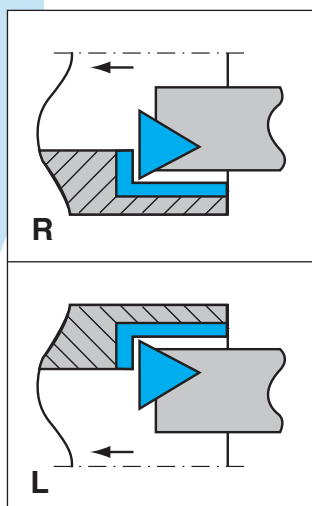

Kierunek skrawania 8
Cutting direction

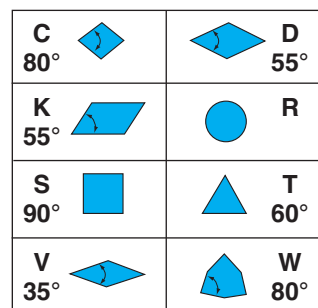

Kształt płytki 5
Insert shape

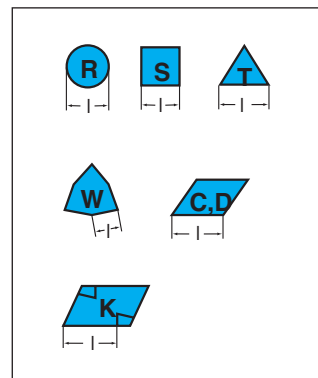

Długość boku płytki 9
Edge length

Np.

W – mocowanie klinem / wedge clamping

D – wymiar f_1 przedłużony o + 1,0 mm
extendend f_1 – dimension, + 1,0 mm

E – wymiar f_1 przedłużony o + 2,0 mm
extendend f_1 – dimension, + 2,0 mm

Informacja dodatkowa / Additional information 10

MSSNR/L

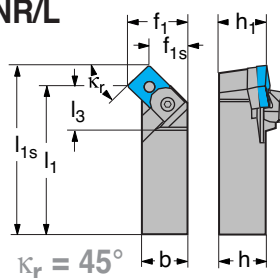

M

Zastosowanie
Application



Oznaczenie
Designation

h h₁ b l₁ l₃ f₁ f_{1s}
(mm) (mm) (mm) (mm) (mm) (mm) (mm)

SNMA
SNMM
SNMG

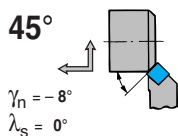

12	MSSNR/L 2525M12	25	25	25	150	158,3	23	32	23,9
19	MSSNR/L 3232P19	32	32	32	170	182,5	31,3	40	27,8
25	MSSNR/L 4040S25	40	40	40	250	266	34	50	34,3

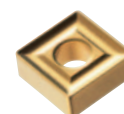

MTJNR/L

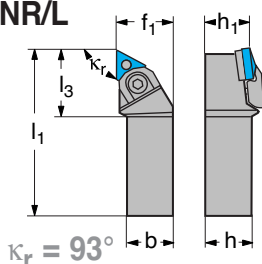

MTGNR/L

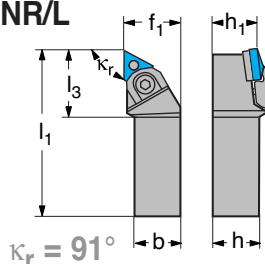

MTENN

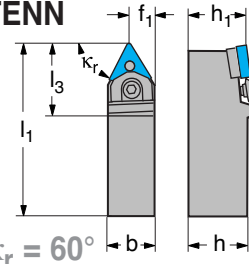

M

Zastosowanie
Application



Oznaczenie
Designation

h h₁ b l₁ l₃ f₁
(mm) (mm) (mm) (mm) (mm) (mm)

TNMA
TNMM
TNMG

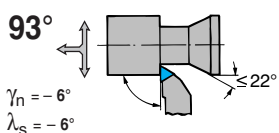

16	MTJNR/L 2020K16M1	20	20	20	125	30,8	25
	MTJNR/L 2525M16M1	25	25	25	150	30,8	32
	MTJNR/L 3225P16M1	32	32	25	170	30,8	32
22	MTJNR/L 2525M22M1	25	25	25	150	34,8	32
	MTJNR/L 3225P22M1	32	32	25	170	34,8	32

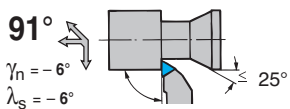

22	MTGNR/L 2525M22M1	25	25	25	150	34,8	32
	MTGNR/L 3225P22M1	32	32	25	170	34,8	32
	MTGNR/L 3232P22M1	32	32	32	170	34,8	40

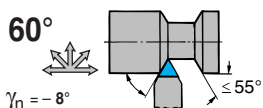

22	MTENN 2525M22M1	25	25	25	150	35,7	13
	MTENN 3225P22M1	32	32	25	170	35,7	13
	MTENN 3232P22M1	32	32	32	170	35,7	16,5



κ_r – kąt przystawienia, γ_n – kąt natarcia, λ_s – kąt pochylenia / tool cutting edge angle / tool normal rake / tool cutting edge indication /

Części zamienne
Spare parts



Klin
Clamp



Pł. podporowa
Shim



Kołek
Pin



Śruba
Screw



Klucz
Key



12	181.38-824-1	181.38-850	181.38-840	3212 010-255	174.1-864 (3,0)
19	181.38-825-1	181.38-851	181.38-841	3212 010-306	174.1-864 (3,0)
25	181.38-826-1	181.38-852	181.38-842	3212 100-357	3021 010-040 (4,0) 3021 010-050 (5,0) 3021 010-040 (4,0)



16	170.38-820-1	170.3-852	5313 021-02	3212 010-206	174.1-863 (2,5)
22	170.38-821-1	170.3-855	181.38-840	3212 010-255	174.1-864 (3,0)

Przykład zamówienia / Ordering example: MSSNR 2525M12 – 1 szt. / pcs

MWLNLR/L

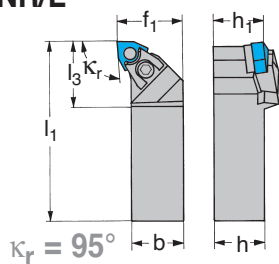

M

Zastosowanie
Application



Oznaczenie
Designation

h h₁ b l₁ l₃ f₁
(mm) (mm) (mm) (mm) (mm) (mm)

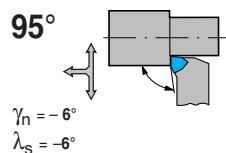

06

MWLNLR/L 2020K06
MWLNLR/L 2525M06

20 20 20 125 26 25
25 25 25 150 26 32

08

MWLNLR/L 2020K08
MWLNLR/L 2525M08
MWLNLR/L 3225P08

20 20 20 125 30 27
25 25 25 150 35 32
32 32 25 170 35 32

WNMA
WNMG



κ_r – kąt przystawienia, γ_n – kąt natarcia, λ_s – kąt pochylenia / tool cutting edge angle / tool normal rake / tool cutting edge indication /

Części zamienne
Spare parts



Docisk
Clamp



Śruba
Screw



Pł. podporowa
Shim



Kolek
Pin



Klucz
Key



06

5431125-011

5512-030-03

5322-331-06

5313022-01

170.3-860 (2,5)
170.3-864 (1,98)

08

5431125-021

3212-010-255

5322-331-07

5313022-03

174.1-864 (3,0)

PCLNR/L

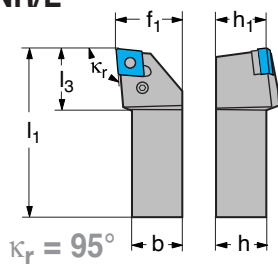

PCBNR/L

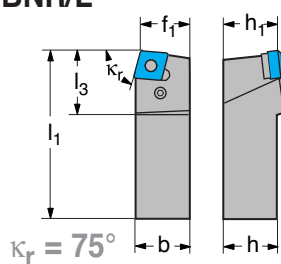

P

Zastosowanie
Application



Oznaczenie
Designation

h (mm) h₁ (mm) b (mm) l₁ (mm) l₃ (mm) f₁ (mm)

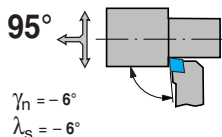

12	PCLNR/L 1616H12-M	16	16	16	100	26,1	20
	PCLNR/L 2020K12	20	20	20	125	29,4	25
	PCLNR/L 2525M12	25	25	25	150	30,0	32
	PCLNR/L 3225P12	32	32	25	170	30,0	32
19	PCLNR/L 2525M19	25	25	25	150	38,0	32
	PCLNR/L 3225P19	32	32	25	170	38,0	32
	PCLNR/L 3232P19	32	32	32	170	38,0	40
	PCLNR/L 4040S19	40	40	40	250	37,0	50

CNMA
CNMM
CNMG

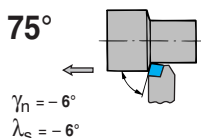

12	PCBNR/L 2525M12	25	25	25	150	29,0	22
19	PCBNR/L 3232P19	32	32	32	170	37,9	27
	PCBNR/L 4040S19	40	40	40	250	37,2	35

PDJNR/L R/L 171.35

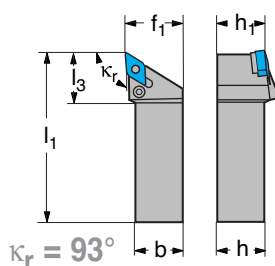

P

Zastosowanie
Application



Oznaczenie
Designation

h (mm) h₁ (mm) b (mm) l₁ (mm) l₃ (mm) f₁ (mm)

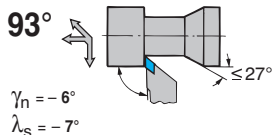

15	PDJNR/L 2020K15	20	20	20	125	34,7	25
	PDJNR/L 2525M15	25	25	25	150	34,7	32
	PDJNR/L 3225P15	32	32	25	170	34,7	40
15	R/L 171.35-4025-15	40	40	25	200	38,0	28,7
	R/L 171.35-5032-15	50	50	32	225	38,0	35

DNMG



κ_r – kąt przystawienia, γ_n – kąt natarcia, λ_s – kąt pochylenia / tool cutting edge angle / tool normal rake / tool cutting edge indication /

Części zamienne
Spare parts



Dźwignia
Lever

Śruba
Screw

Pł. podporowa
Shim

Tuleja sprężysta
Shim pin

Klucz
Key



12	dla/for ..-M	174.3-848M	174.3-858	171.31-850M	174.3-861	174.1-864 (3,0)
		174.3-841M	174.3-821	-	-	171.1-864 (3,0)
19		174.3-842M	174.3-822M	171.31-851M	174.3-862	3021 010-040 (4,0)
12	dla/for ..-M12	174.3-841M	174.3-821	171.31-850M	174.3-861	174.1-864 (3,0)



15		174.3-847M	174.3-830	171.35-851M	174.3-861	174.1-864 (3,0)
----	--	------------	-----------	-------------	-----------	-----------------

Przykład zamówienia / Ordering example: PCLNR 1616H12-M – 1 szt. / pcs

PSBNR/L

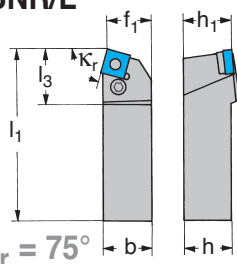

PSKNR/L

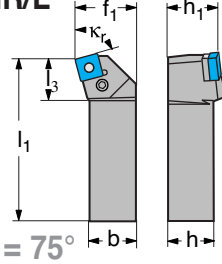

PSDNN

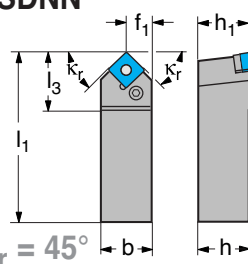

PSSNR/L

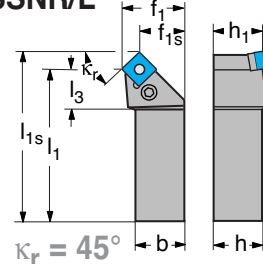

P

Zastosowanie Application	Oznaczenie Designation	h (mm)	h ₁ (mm)	b (mm)	l ₁ (mm)	l _{1s} (mm)	l ₃ (mm)	f ₁ (mm)	f _{1s} (mm)
	09 PSBNR/L 1616K09	16	16	16	100	-	20,8	13	-
	PSBNR/L 2020K09	20	20	20	125	-	23,0	17	-
	12 PSNR/L 1212F09	12	12	12	80	-	21,0	13	-
	PSBNR/L 2020K12	20	20	20	125	-	27,5	17	-
	PSBNR/L 2525M12	25	25	25	150	-	27,5	22	-
	PSBNR/L 3225P12	32	32	25	170	-	27,5	22	-
	19 PSBNR/L 3232P19	32	32	32	170	-	39,2	27	-
	PSBNR/L 4040S19	40	40	40	250	-	41,5	35	-
	25 PSBNR/L 4040S25	40	40	40	250	-	47,5	35	-
	PSBNR/L 5050T25	50	50	50	300	-	47,5	43	-
	09 PSKNR/L 1616K09	16	16	16	100	-	16,5	20	-
	PSKNR/L 2020K09	20	20	20	125	-	17,4	25	-
	12 PSKNR/L 2020K12	20	20	20	125	-	22,7	25	-
	PSKNR/L 2525M12	25	25	25	150	-	22,7	32	-
	PSKNR/L 3225P12	32	32	25	170	-	22,7	32	-
	19 PSKNR/L 3232P19	32	32	32	170	-	37,5	40	-
	PSKNR/L 4040S19	40	40	40	250	-	32,9	50	-
	25 PSKNR/L 5050T25	50	50	50	300	-	37,5	60	-
	09 PSDNN 1010E09	10	10	10	70	-	20,0	5,3	-
	PSDNN 1212E09	12	12	12	80	-	20,0	6,3	-
	12 PSDNN 1616H09	16	16	16	100	-	21,0	8,3	-
	PSDNN 2020K12	20	20	20	125	-	27,6	10,3	-
	PSDNN 2525M12	25	25	25	150	-	27,6	12,8	-
	PSDNN 3225P12	32	32	25	170	-	27,6	12,8	-
	19 PSDNN 3225P19	32	32	25	170	-	40,4	13,0	-
	PSDNN 3232P19	32	32	32	170	-	40,4	16,5	-
	25 PSDNN 4040S25	40	40	40	250	-	48,8	21,0	-
	09 PSSNR/L 1616H09	16	16	16	100	106,1	22,0	20	13,9
	PSNR/L 2020K09	20	20	20	125	131,1	21,9	25	18,9
	PSNR/L 2525M09	25	25	25	150	156,1	23,0	32	25,9
	12 PSSNR/L 2020K12	20	20	20	125	133,3	29,3	25	17,0
	PSNR/L 2525M12	25	25	25	150	158,3	29,3	32	24,0
	PSNR/L 3225P12	32	32	25	170	178,3	29,3	32	24,0
	15 PSSNR/L 2525M15	25	25	25	150	160,2	34,0	32	21,8
PSNR/L 3225P15	32	32	25	150	180,2	34,0	32	21,8	
PSNR/L 3232P15	32	32	32	170	180,2	34,0	40	29,8	
19 PSSNR/L 3232P19	32	32	32	170	182,5	41,3	40	27,9	
PSNR/L 4040S19	40	40	40	250	262,5	41,5	50	37,9	
25 PSSNR/L 4040S25	40	40	40	250	266	8,8	50	34,4	
	09*	174.3-840-1	174.3-829	-	-	-	-	170.1-870 (1,98)	
	09	174.3-840M	174.3-820M	174.3-850M	-	-	-	170.1-860 (2,5)	
	12	174.3-841M	174.3-821	174.3-851M	174.3-861	-	-	174.1-864 (3,0)	
	19	174.3-842M	174.3-822M	174.3-852M	174.3-862	-	-	3021 010-040 (4,0)	
	25	174.3-844M	174.3-827	174.3-853M	174.3-865	-	-	3021 010-050 (5,0)	

Części zamienne Spare parts



Dźwignia
Lever

Śruba
Screw

Pł. podporowa
Shim

Tuleja sprężysta
Shim pin

Klucz
Key

* tylko dla PSNR/L 1212F09

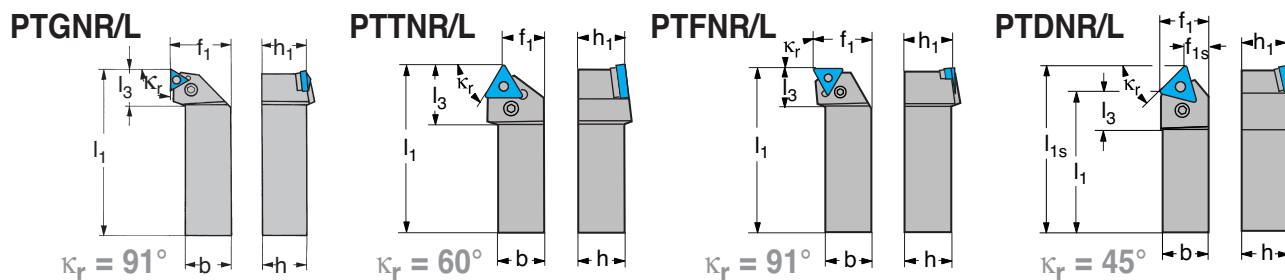

P

Zastosowanie Application		Oznaczenie Designation	h (mm)	h ₁ (mm)	b (mm)	l ₁ (mm)	l ₃ (mm)	f ₁ (mm)			
 $\gamma_n = -6^\circ$ $\lambda_s = -6^\circ$	16	PTG NR/L 1616H16 PTG NR/L 2020K16 PTG NR/L 2525M16 PTG NR/L 3225P16	16 20 25 32	16 20 25 32	16 20 25 25	100 125 150 170	20,2 20,2 22,2 22,2	20 25 32 32			
	22	PTG NR/L 2525M22 PTG NR/L 3225P22 PTG NR/L 3232P22	25 32 32	25 32 32	25 25 32	150 170 170	28,7 28,7 28,7	32 32 40			
	27	PTG NR/L 3232P27 PTG NR/L 4040S27	32 40	32 40	32 40	170 250	35,2 34	40 50			
	16	PTT NR/L 1616H16 PTT NR/L 2020K16	16 20	16 20	16 20	100 125	23,4 25,9	13 17			
	22	PTT NR/L 2525M22 PTT NR/L 3225P22	25 32	25 32	25 25	150 170	31,9 31,9	22 22			
	 $\gamma_n = -6^\circ$ $\lambda_s = -6^\circ$	16	PTF NR/L 1616H16 PTF NR/L 2020K16 PTF NR/L 2525M16	16 20 25	16 20 25	16 20 25	100 125 150	19,7 20,2 20,2	20 25 32		
22		PTF NR/L 2525M22 PTF NR/L 3225P22 PTF NR/L 3232P22	25 32 32	25 32 32	25 25 32	150 170 170	25,2 25,2 25,2	32 32 40			
27		PTF NR/L 3232P27 PTF NR/L 4040S27	32 40	32 40	32 40	170 250	34,4 33,2	40 50			
 $\gamma_n = -7^\circ$ $\lambda_s = 0^\circ$		22	PTD NR/L 2525M22	25	25,9	25	136	150	19,5	27	13

TNMA
TNMM
TNMG



κ_r – kąt przystawienia, γ_n – kąt natarcia, λ_s – kąt pochylenia / tool cutting edge angle / tool normal rake / tool cutting edge indication /

Części zamienne Spare parts



Dźwignia
Lever



Śruba
Screw



Pł. podporowa
Shim



Tuleja sprężysta
Shim pin



Klucz
Key



16
22
27

174.3-840M
174.3-841M
174.3-843M

174.3-820M
174.3-821
174.3-825

179.3-850M
179.3-852M
179.3-854M

174.3-860
174.3-861
174.3-864

170.3-860 (2,5)
174.1-864 (3,0)
174.1-864 (3,0)

PRGNR/L

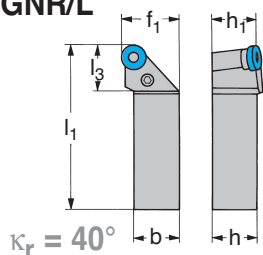

$\kappa_r = 40^\circ$

PRGCR/L

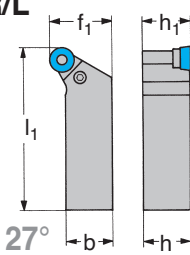

$\kappa_r = 27^\circ$

N 176.39

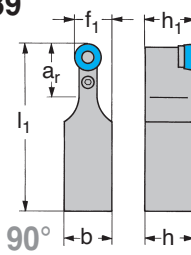

$\kappa_r = 90^\circ$

P

Zastosowanie Application	Oznaczenie Designation	h (mm)	h ₁ (mm)	b (mm)	l ₁ (mm)	l ₃ (mm)	a _r (mm)	f ₁ (mm)	RNMG
	09 PRGNR/L 2020K09	20	20	20	125	20,8	-	25	
	12 PRGNR/L 2525M12	25	25	25	150	27,2	-	32	
	15 PRGNR/L 3225P15	32	32	25	170	33,2	-	32	
	19 PRGNR/L 3232P19	32	32	32	170	38,0	-	40	
	25 PRGNR/L 4040S25	40	40	40	250	41,9	-	50	
	10 PRGCR/L 2020K10	20	20	20	125	-	-	25	
	12 PRGCR/L 2525M10	25	25	25	150	-	-	32	
	12 PRGCR/L 2020K12	20	20	20	125	-	-	25	
	12 PRGCR/L 2525M12	25	25	25	150	-	-	32	
	12 PRGCR/L 3225P12	32	32	25	170	-	-	32	
20 PRGCR/L 3232P20	32	32	32	170	-	-	40		
25 PRGCR/L 4040S25	40	40	40	250	-	-	50		
	10 N 176.39-2020-10	20	20	20	150	-	25	15,0	
	12 N 176.39-2525-12	25	25	25	150	-	28	18,5	
	12 N 176.39-3225-12	32	32	25	180	-	28	18,5	
	20 N 176.39-3232-20	32	32	32	180	-	40	26,0	
	25 N 176.39-4040-25	40	40	40	300	-	50	32,5	

κ_r – kąt przystawienia, γ_n – kąt natarcia, λ_s – kąt pochylenia / tool cutting edge angle / tool normal rake / tool cutting edge indication /

Części zamienne Spare parts



Dźwignia
Lever

Śruba
Screw

Pł. podporowa
Shim

Tuleja sprężysta
Shim pin

Klucz
Key



09	174.3-840M	174.3-820M	176.3-850	174.3-863	170.3-860 (2,5)
12	174.3-841M	174.3-821	176.3-851M	174.3-861	174.1-864 (3,0)
15	174.3-843M	174.3-825	176.3-854M	174.3-864	174.1-864 (3,0)
19	174.3-842M	174.3-822M	176.3-852M	174.3-862	3021 010-040 (4,0)
25	174.3-844M	174.3-827	176.3-853M	174.3-865	3021 010-050 (5,0)
10	176.39-840	174.3-834	176.39-850	174.3-860	170.3-864 (1,98)
12	5432 005-01	174.3-820M	176.39-851	174.3-863	170.3-860 (2,5)
20	176.39-843	174.3-825	176.39-853	174.3-864	174.1-864 (3,0)
25	176.39-844	174.3-832	176.39-854	174.3-862	3021 010-040 (4,0)
10	176.39-840	174.3-834	176.39-850	174.3-860	170.3-864 (1,98)
12	5432 005-01	174.3-820M	176.39-851	174.3-863	170.3-860 (2,5)
20	176.39-843	174.3-825	176.39-853	174.3-864	174.1-864 (3,0)
25	176.39-844	174.3-832	176.39-854	174.3-862	3021 010-040 (4,0)

SCLCR/L

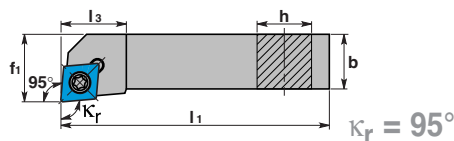

S

Zastosowanie
Application



Oznaczenie
Designation

h b l_{1s} l₃ f₁
(mm) (mm) (mm) (mm) (mm)

CCMT

06	SCLCR/L 0808K06-S	8	8	125	8	8
	SCLCR/L 1010K06-S	10	10	125	10	10
	SCLCR/L 1212K06-S	12	12	125	12	12
	SCLCR/L 1616K06-S	16	16	125	16	16
09	SCLCR 1212F09-M	12	12	80	19,5	16
	SCLCR 1616H09	16	16	100	18	20
	SCLCR 2020K09	20	20	125	18	25
12	SCLCR 2020K12	20	20	125	25	25
	SCLCR 2525M12	25	25	150	25	32



CCGT

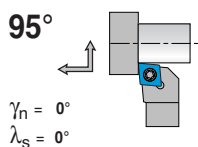
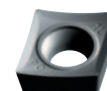

SDJCR/L

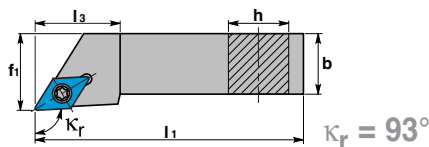

S

Zastosowanie
Application



Oznaczenie
Designation

h b l₁ l₃ f₁
(mm) (mm) (mm) (mm) (mm)

DCMT

07	SDJCR/L 1010E07	10	10	70	17	12
	SDJCR/L 1212F07	12	12	80	19	16
	SDJCR/L 1616H07	16	16	100	19	20
	SDJCR/L 2020K07	20	20	125	22	25
11	SDJCR/L 2020K11	20	20	125	24	25
	SDJCR/L 2525M11	25	25	150	28	32



DCGT

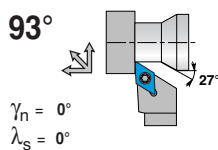

κ_r – kąt przystawienia, γ_n – kąt natarcia, λ_s – kąt pochylenia / tool cutting edge angle / tool normal rake / tool cutting edge indication /

Części zamienne
Spare parts



Śruba
Screw



Pł. podporowa
Shim



Śruba pł. podpor.
Shim screw



Klucz
Key



06	5513 020-03 (M2,5)	–	–	416.1-861 (T8)
	09 5513 020-01 (M3,5)	5322 232-01	5512 090-01	5680 049-01 (T15/3,5)
	dla/for ...-M 5513 020-10 (M3,5)	–	–	5680 016-01 (T15/3,5)
12	5513 020-18 (M4)	5322 232-02	5512 090-03	5680 049-01 (15IP)



07	5513 020-03 (M2,5)	–	–	5680 051-02 (7IP)
	11 5513 020-01 (M3,5)	5322 263-01	–	5680 049-01 (15IP)

Przykład zamówienia / Ordering example: SCLCR 0808J06 – 1 szt. / pcs

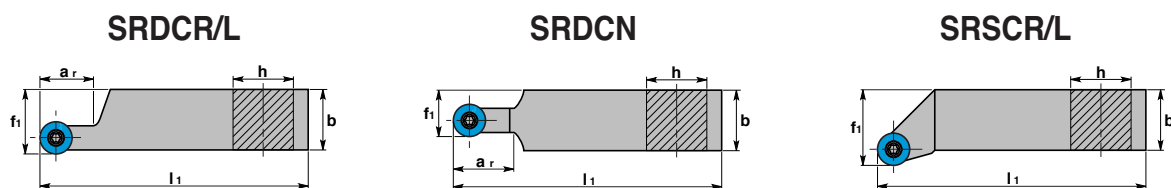

S

Zastosowanie Application	Oznaczenie Designation	h (mm)	b (mm)	l ₁ (mm)	a _r (mm)	f ₁ (mm)
	06 SRDCR/L 2020K06A	20	20	125	20	20,5
	SRDCR/L 3225P06A	32	25	170	20	25,5
	08 SRDCR/L 2020K08A	20	20	125	20	20,5
	SRDCR/L 2525M08A	25	25	150	20	25,5
	SRDCR/L 3225P08A	32	25	170	20	25,5
	06 SRDCN 1212F06	12	12	80	12	9
	08 SRDCN 1616H08	16	16	100	16	12
	10 SRDCN 2020K10A	20	20	125	25	15
	SRDCN 2525M10A	25	25	150	25	17,5
	12 SRDCN 2525M12A	25	25	150	28	18,5
SRDCN 3225P12A	32	25	170	28	18,5	
	06 SRSCR/L 3225P06	32	25	170	-	32
	08 SRSCR/L 3225P08	32	25	170	-	32
	10 SRSCR/L 2020K10	20	20	125	-	25
	12 SRSCR/L 2525M12	25	25	150	-	32
	SRSCR/L 3225P12	32	25	170	-	32

RCMT



κ_r – kąt przystawienia, γ_n – kąt natarcia, λ_s – kąt pochylenia / tool cutting edge angle / tool normal rake / tool cutting edge indication /

Części zamienne Spare parts



Śruba
Screw



Pł. podporowa
Shim



Śruba pł. podpor.
Shim screw



Klucz
Key



06	5513 020-05 (M2,2)	-	-	5680 051-02 (7IP)
08	5513 020-04 (M3)	-	-	5680 051-03 (9IP)
10	5513 020-10 (M3,5)	5322 110-01	5512 090-01	5680 016-01 (T15/3,5)
12	5513 020-01 (M3,5)	5322 110-02	5512 090-01	5680 016-01 (T15/3,5)

Przykład zamówienia / Ordering example: SRDCR 2020K08A – 1 szt. / pcs

SSBCR/L

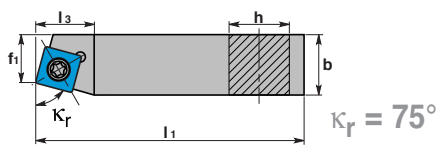

SSKCR/L

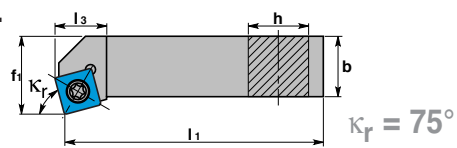

SSDCR/L

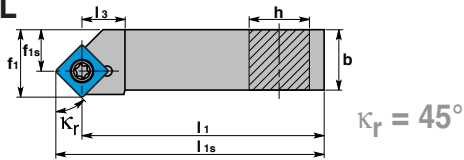

SSDCN

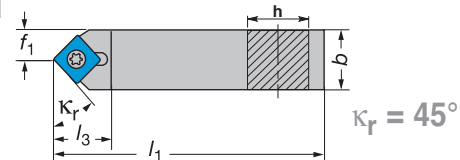

S

Zastosowanie
Application



Oznaczenie
Designation

h (mm) b (mm) l1 (mm) l3 (mm) f1 (mm) l1s (mm) f1s (mm)

75°

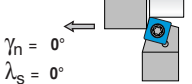

$\gamma_n = 0^\circ$
 $\lambda_s = 0^\circ$

09

SSBCR/L 1616H09

16 16 100 15,5 13 - -

12

SSBCR/L 2020K12
SSBCR/L 2525M12

20 20 125 21 17 - -
25 25 150 24 22 - -

SCMT



45°

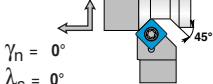

$\gamma_n = 0^\circ$
 $\lambda_s = 0^\circ$

09

SSDCR/L 1616H09

16 16 93,9 9,4 17 100 10,9

12

SSDCR/L 2020K09
SSDCR/L 2020K12
SSDCR/L 2525M12

20 20 118,9 12,9 22 125 15,9
20 20 116,7 15,7 22 125 13,7
25 25 141,7 15,7 27 150 18,7

SCGT

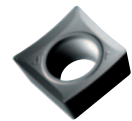

75°

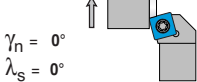

$\gamma_n = 0^\circ$
 $\lambda_s = 0^\circ$

09

SSKCR/L 1616H09

16 16 100 10,8 20 - -

45°



$\gamma_n = 0^\circ$
 $\lambda_s = 0^\circ$

09

SSDCN 1212F09-M
SSDCN 1616H09

12 12 80 15,5 6 - -
16 16 100 15,5 8 - -

κ_r – kąt przystawienia, γ_n – kąt natarcia, λ_s – kąt pochylenia / tool cutting edge angle / tool normal rake / tool cutting edge indication /

Części zamienne
Spare parts



Śruba
Screw



Pł. podporowa
Shim



Śruba pł. podpor.
Shim screw



Tuleja pł. podporowej
Shim pin



Klucz
Key



09*

5513 020-10 (M3,5)

-

-

-

5680 049-01 (15IP)

09

5513 020-01 (M3,5)

5322 420-01

5512 090-01

-

5680 049-01 (15IP)

12

5513 020-18 (M4x0,5)

5322 420-02

5512 090-03

-

5680 049-01 (3,5)

5680 049-02 (15IP)

5680 049-02 (4,0)

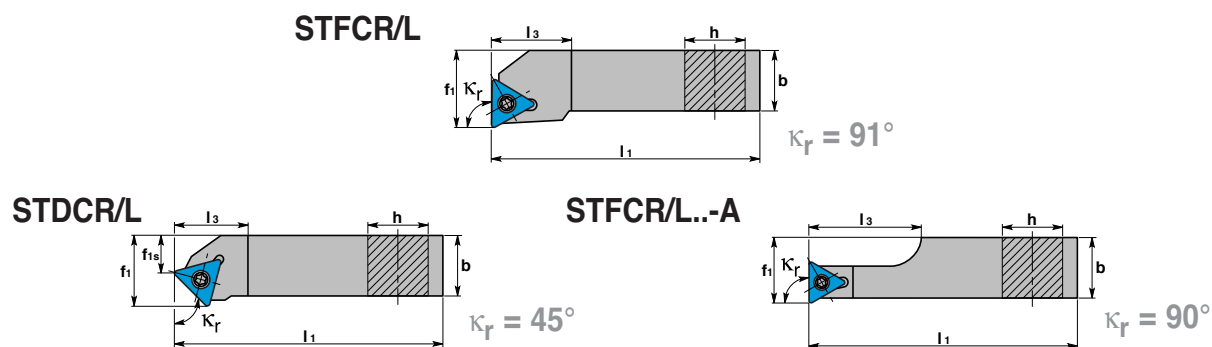

S

Zastosowanie Application	Oznaczenie Designation	h (mm)	b (mm)	l ₁ (mm)	l ₃ (mm)	f ₁ (mm)	f _{1s} (mm)
45° $\gamma_n = 0^\circ$ $\lambda_s = 0^\circ$	11 STDCR/L 1212F11	12	12	80	17,4	13	6
	16 STDCR/L 1616H11	16	16	100	17,4	17	10
91° $\gamma_n = 0^\circ$ $\lambda_s = 0^\circ$	11 STFCR/L 1212F11	12	12	80	16	16	-
	16 STFCR/L 1616H11	16	16	100	16	20	-
	16 STFCR/L 1616H16	16	16	100	22	20	-
	16 STFCR/L 2020K16	20	20	125	22	25	-
16 STFCR/L 2525M16	25	25	150	24	32	-	
90° $\gamma_n = 0^\circ$ $\lambda_s = 0^\circ$	11 STFCR/L 2020K11-A	20	20	125	37	20,8	-

TCMT



TCGT



κ_r – kąt przystawienia, γ_n – kąt natarcia, λ_s – kąt pochylenia / tool cutting edge angle / tool normal rake / tool cutting edge indication /

Części zamienne Spare parts



Śruba
Screw



Pł. podporowa
Shim



Śruba pł. podpor.
Shim screw



Klucz
Key



11
16

5513 020-03 (M2,5)
5513 020-01 (M3,5)

-
5322 320-01

-
5512 090-01

5680 051-02 (7IP)
5680 049-01 (15IP)
5680 049-01 (3,5)

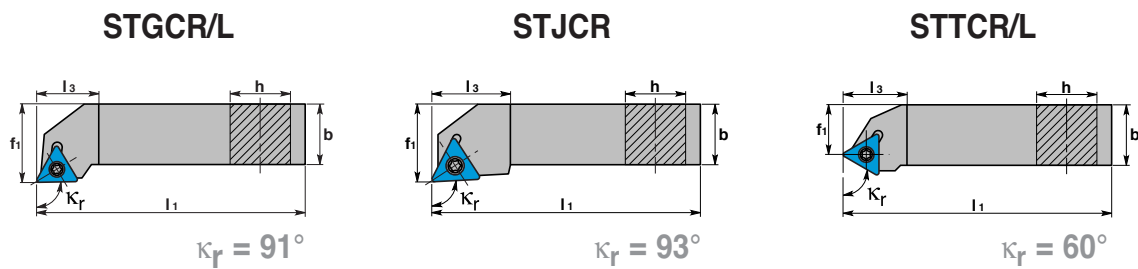

S

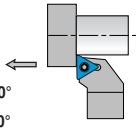
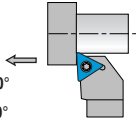
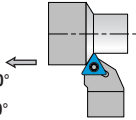
Zastosowanie Application		Oznaczenie Designation	h (mm)	b (mm)	l ₁ (mm)	l ₃ (mm)	f ₁ (mm)	
91°  $\gamma_n = 0^\circ$ $\lambda_s = 0^\circ$	11	STGCR/L 1212F11	12	12	80	16,3	16	
		STGCR/L 1616H11	16	16	100	16,3	20	
		16	STGCR/L 1616H16	16	16	100	25	20
			STGCR/L 2020K16	20	20	125	26	25
STGCR/L 2525M16	25	25	150	27	32			
93°  $\gamma_n = 0^\circ$ $\lambda_s = 0^\circ$	11	STJCR 1010K11-S	10	10	125	16	10	
		STJCR 1212K11-S	12	12	125	16	12	
		STJCR 1616K11-S	16	16	125	16	16	
60°  $\gamma_n = 0^\circ$ $\lambda_s = 0^\circ$	11	STTCR/L 1616H11	16	16	100	16,4	13	
		16	STTCR/L 1616H16	16	16	100	25	13
	STTCR/L 2020K16		20	20	125	25	17	
	STTCR/L 2525M16		25	25	150	25	22	

TCMT



TCGT

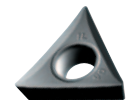

κ_r – kąt przystawienia, γ_n – kąt natarcia, λ_s – kąt pochylenia / tool cutting edge angle / tool normal rake / tool cutting edge indication /

Części zamienne Spare parts



Śruba
Screw



Pł. podporowa
Shim



Śruba pł. podpor.
Shim screw



Tuleja pł. podporowej
Shim pin



Klucz
Key



11	5513 020-03 (M2,5)	–	–	–	5680 051-02 (7IP)	
	16	5513 020-01 (M3,5)	5322 320-01	5512 090-01	–	5680 049-01 (15IP)
	16 dla/for STJCR	5513 020-49 (M4)	179.3-850M	–	174.3-860	5680 049-01 (3,5)
16					5680 016-01 (T15/3,5)	

Przykład zamówienia / Ordering example: STGCR 1212F11 – 1 szt. / pcs

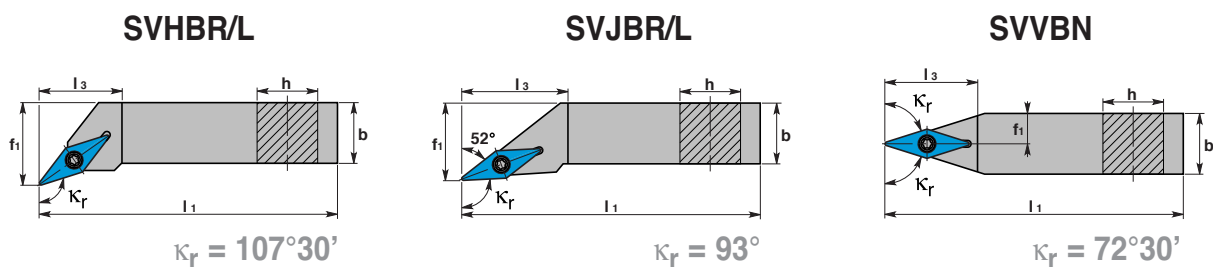

S

Zastosowanie Application	Oznaczenie Designation	h (mm)	b (mm)	l ₁ (mm)	l ₃ (mm)	f ₁ (mm)	
107°30' $\gamma_n = 0^\circ$ $\lambda_s = 0^\circ$	16	SVHBR/L 2020K16	20	20	125	31,5	25
		SVHBR/L 2525M16	25	25	150	31,5	32
		SVHBR/L 3225P16	32	25	170	31,5	32
93° $\gamma_n = 0^\circ$ $\lambda_s = 0^\circ$	11	SVJBR/L 1212F11	12	12	80	27	16
		SVJBR/L 1616H11	16	16	100	27	20
		SVJBR/L 2020K11	20	20	125	27	25
		SVJBR/L 2525M11	25	25	150	27	32
72°30' $\gamma_n = 0^\circ$ $\lambda_s = 0^\circ$	16	SVJBR/L 2020K16	20	20	125	31,5	25
		SVJBR/L 2525M16	25	25	150	31,5	32
		SVJBR/L 3225P16	32	25	170	31,5	32
	11	SVVBN 1212F11	12	12	80	27	6,3
		SVVBN 1616H11	16	16	100	27	8,3
		SVVBN 2020K11	20	20	125	27	10,3
	SVVBN 2525M11	25	25	150	39,9	12,8	
	16	SVVBN 2020K16	20	20	125	31,5	10,6
	SVVBN 2525M16	25	25	150	31,5	13,1	
	SVVBN 3225P16	32	25	170	31,5	13,1	

VBMT



VCGT



κ_r – kąt przystawienia, γ_n – kąt natarcia, λ_s – kąt pochylenia / tool cutting edge angle / tool normal rake / tool cutting edge indication /

Części zamienne Spare parts



11	5513 020-03 (M2,5)	–	–	5680 051-02 (7IP)
16	5513 020-01 (M3,5)	5322 270-01	5512 090-01	5680 049-01 (15IP) 5680 049-01 (3,5)

S..-MVUNR/L

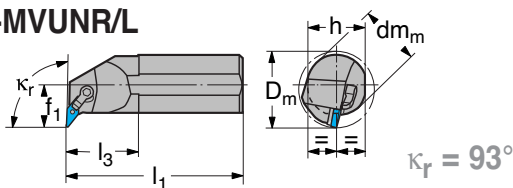

M

Zastosowanie
Application



Oznaczenie
Designation

dm_m h l₁ l₃ f₁ D_m_{min}
(mm) (mm) (mm) (mm) (mm) (mm)

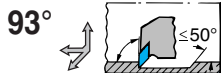

$\gamma_n = -6^\circ$
 $\lambda_s = -10^\circ$

16

S40V-MVUNR/L 16

40 37 400 56 27 50

VNMG



A..-MWLNR/L

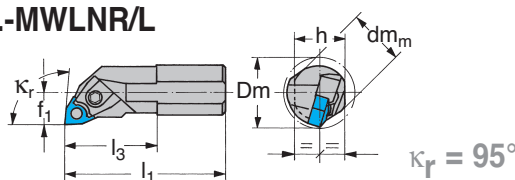

M

Zastosowanie
Application



Oznaczenie
Designation

dm_m h l₁ l₃ f₁ D_m_{min} λ_s
(mm) (mm) (mm) (mm) (mm) (mm) (°)

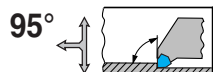

$\gamma_n = -6^\circ$
 $\lambda_s = \dots$

06

A20S-MWLNR/L 06

20 18 250 32,3 13 25 -14°

A25T-MWLNR/L 06

25 23 300 31,7 17 32 -12°

A32U-MWLNR/L 06

32 30 350 40,0 22 40 -14°

08

A25T-MWLNR/L 08

25 23 300 39,9 17 32 -14°

A32U-MWLNR/L 08

32 30 350 40,0 22 40 -14°

A40V-MWLNR/L 08

40 37 400 56,0 27 50 -12°

A50W-MWLNR/L 08

50 47 450 60,0 35 63 -10°

WNMA
WNMG



κ_r – kąt przystawienia, γ_n – kąt natarcia, λ_s – kąt pochylenia / tool cutting edge angle / tool normal rake / tool cutting edge indication /

Części zamienne
Spare parts



Docisk
Clamp



Śruba
Screw



Pł. podporowa
Shim



Kołek
Pin



Klucz
Key



16

MC-12

MS-510

MVN-322

MN-34L

174.1-870 (1,98)
3021 011-532 (3,96)

06

dla/for A20S

5431 125-011

–

–

5313 022-02

170.3-860 (2,5)
170.3-864 (1,98)

dla/for A25T

5431 125-011

5512 030-03

5322 331-11

5313 022-01

170.3-860 (2,5)
170.3-864 (1,98)

dla/for A32U

5431 125-011

–

5322 331-06

5313 022-02

170.3-860 (2,5)

08

dla/for A25T

5431 125-021

–

5322 331-09

5313 022-03

174.1-864 (3,0)

dla/for A40V

5431 125-021

5512 030-04

5322 331-07

5313 022-03

174.1-864 (3,0)

dla/for A50W

5431 125-021

5512 030-04

5322 331-07

5313 022-03

174.1-863 (2,5)
174.1-864 (3,0)
174.1-863 (2,5)

Przykład zamówienia / Ordering example: S40S-MWLNR 16 – 1 szt. / pcs

S..-PCLNR/L

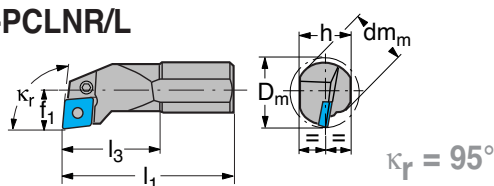

P

Zastosowanie
Application



Oznaczenie
Designation

dm_m h l₁ l₃ f₁ D_mmin λ_s
(mm) (mm) (mm) (mm) (mm) (mm) (°)

CNMA
CNMM
CNMG

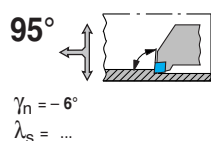

12	S25T-PCLNR/L 12 S32U-PCLNR/L 12 S40V-PCLNR/L 12	25 32 40	23 30 37	300 350 400	37 40 56	17 22 27	32 40 50	-13° -11° -10°
19	S50W-PCLNR/L 19	50	47	450	63	35	63	-11°



S..-PDUNR/L

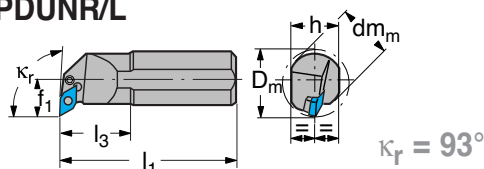

P

Zastosowanie
Application



Oznaczenie
Designation

dm_m h l₁ l₃ f₁ D_mmin λ_s
(mm) (mm) (mm) (mm) (mm) (mm) (°)

DNMG

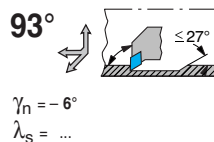

15	S40V-PDUNR/L 15 S50W-PDUNR/L 15	40 50	37 47	400 450	56 63	27 35	50 63	-11° -10°
----	------------------------------------	----------	----------	------------	----------	----------	----------	--------------



κ_r – kąt przystawienia, γ_n – kąt natarcia, λ_s – kąt pochylenia / tool cutting edge angle / tool normal rake / tool cutting edge indication /

Części zamienne
Spare parts



Dźwignia
Lever

Śruba
Screw

Pł. podporowa
Shim

Tuleja sprężysta
Shim pin

Klucz
Key

12	dla/for S25T	438.3-832M	174.3-832M	–	–	174.1-863 (2,5)
	dla/for S32U	174.3-848M	174.3-858	171.31-850M	174.3-861	174.1-864 (3,0)
	dla/for S40V	174.3-841M	174.3-821	171.31-850M	174.3-861	174.1-864 (3,0)
19		174.3-849M	174.3-822M	171.31-851M	174.3-868	3021 010-040 (4,0)
15		174.3-847M	174.3-830	171.35-850M		174.1-864 (3,0)

S...PSKNR/L

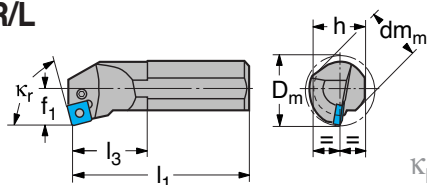

P

Zastosowanie
Application



Oznaczenie
Designation

dm_m h l₁ l₃ f₁ D_mmin λ_s
(mm) (mm) (mm) (mm) (mm) (mm) (°)

SNMA
SNMM
SNMG

75°

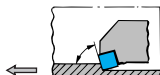

γ_n = -6°
λ_s = ...

12

S25T-PSKNR/L 12 25 23 300 36,8 17 32 -11°
S32U-PSKNR/L 12 32 30 350 37,8 22 40 -10°
S40V-PSKNR/L 12 40 37 400 49,8 27 50 -10°



S...PTFNR/L

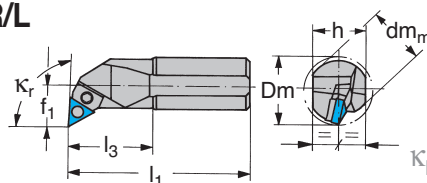

P

Zastosowanie
Application



Oznaczenie
Designation

dm_m h l₁ l₃ f₁ D_mmin λ_s
(mm) (mm) (mm) (mm) (mm) (mm) (°)

TNMA
TNMM
TNMG

91°

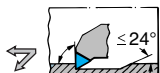

γ_n = -6°
λ_s = ...

16

S25T-PTFNR/L 16-W 25 23 300 36,8 17 32 -13°
S32U-PTFNR/L 16-W 32 30 350 45 22 40 -12°
S40V-PTFNR/L 16-W 40 37 400 49,5 27 50 -11°
S50W-PTFNR/L 16-W 50 47 450 56 35 63 -10°



22

S40V-PTFNR/L 22W 40 37 400 58,9 27 50 -11°
S50W-PTFNR/L 22W 50 47 450 65,9 35 63 -10°

κ_r – kąt przystawienia, γ_n – kąt natarcia, λ_s – kąt pochylenia / tool cutting edge angle / tool normal rake / tool cutting edge indication /

Części zamienne
Spare parts



Dźwignia
Lever

Śruba
Screw

Pł. podporowa
Shim

Tuleja sprężysta
Shim pin

Kotek
Pin

Klucz
Key



12 dla/for S25T 438.3-832M 174.3-832M – – -174.3-863 (2,5)
dla/for S32U 174.3-848M 174.3-858 174.3-851M 174.3-861 -174.1-864 (3,0)
dla/for S40V 174.3-841M 174.3-821 174.3-851M 174.3-861 -174.1-864 (3,0)



16 dla/for S25T 170.38-823-2 5512 031-01 – – 5313 021-01 174.1-864 (3,0)
5680 051-03 (9IP)
dla/for S32U, S40V 170.38-823-1 5512 031-01 170.3-852 – 5313 021-02 174.1-864 (3,0)
5680 051-03 (9IP)
dla/for S50W 170.38-823-1 3212 100-206 170.3-852 – 5313 021-02 174.1-864 (3,0)
174.1-870 (1,98)
22 170.38-824-1 5512 031-02 170.3-855 – 5313 021-03 3021 010-040 (4,0)
5680 049-02 (15IP)

S..-CKUNR/L

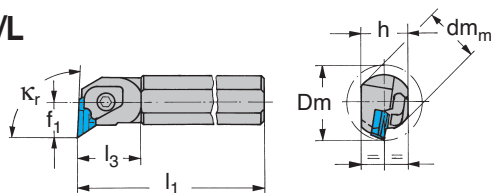

$\kappa_r = 93^\circ$

C

Zastosowanie
Application



Oznaczenie
Designation

dm_m h l_1 l_3 f_1 D_{mmin}
(mm) (mm) (mm) (mm) (mm) (mm)

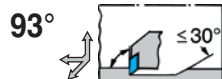

$\gamma_n = -6^\circ$
 $\lambda_s = -10^\circ$

16

S32U-CKUNR/L 16

32

30

350

54

22

44

S40V-CKUNR/L 16

40

37

400

54

27

48

KNUX

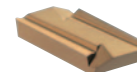

Do noża w wersji prawej stosować płytkę lewą.
With a right-hand toolholder use a left-hand insert.

A..-SCLCR/L

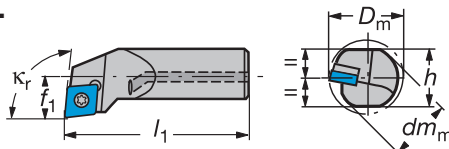

$\kappa_r = 95^\circ$

S

Zastosowanie
Application



Oznaczenie
Designation

dm_m l_1 h f_1 D_{mmin}
(mm) (mm) (mm) (mm) (mm)

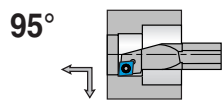

$\gamma_n = 0^\circ$
 $\lambda_s = -5^\circ$

06

A08H-SCLCR/L 06

08

100

7

5

10

A10K-SCLCR/L 06

10

125

9

6

12

A12M-SCLCR/L 06

12

150

11

9

16

A16R-SCLCR/L 06

16

200

15

11

20

09

A16R-SCLCR 09

16

200

15

11

20

A20S-SCLCR/L 09

20

250

18

13

25

A25T-SCLCR/L 09

25

300

23

17

32

12

A25T-SCLCR/L 12

25

300

23

17

32

A32T-SCLCR/L 12

32

300

30

22

40

A40T-SCLCR/L 12

40

300

37

23

50

CCMT



CCGT

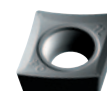

κ_r – kąt przystawienia, γ_n – kąt natarcia, λ_s – kąt pochylenia / tool cutting edge angle / tool normal rake / tool cutting edge indication /

Części zamienne
Spare parts



Docisk R
Clamp R

Docisk L
Clamp L

Śruba
Screw

Pł. podporowa
Shim

Sprężyna
Spring

Sprężyna i kołek
Spring and pin

Klucz
Key



16

170.5-825

170.5-824

170.5-865

170.5-851

170.5-848

170.5-841

3021 010-040 (4,0)



Śruba
Screw

Pł. podporowa
Shim

Śruba
Screw



Klucz
Key



06

5513 020-03

–

–

5680 051-02 (7IP)

09

dla/for 16-20

5513 020-09

–

–

5680 049-01 (15IP)

09

dla/for 25

5513 020-10

–

–

5680 049-01 (15IP)

12

dla/for 25

5513 020-17

–

–

5680 049-02 (15IP)

12

dla/for 32-40

5513 020-18

5322 232-02

5512 090-03

5680 049-02 (15IP)

Przykład zamówienia / Ordering example: S32U-CKUNR 16 – 1 szt. / pcs

A..SDUCR/L

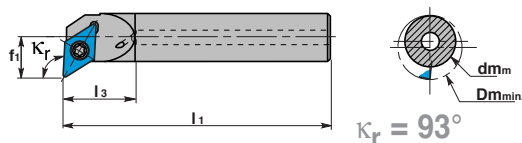

S

Zastosowanie
Application



Oznaczenie
Designation

dm_m l_1 l_3 h f_1 D_{mmin} λ_s γ_n
(mm) (mm) (mm) (mm) (mm) (mm) (°) (°)

DCMT



07 A10K-SDUCR/L 07

10 125 19,8 9 7 13 -9° 0°

A12M-SDUCR/L 07

12 150 22 11 9 16 -6,5° 0°

A16R-SDUCR/L 07

16 200 27 15 11 20 -4° 0°

11 A20S-SDUCR/L 11

20 250 30,4 18 13 25 -5,5° 0°

A25T-SDUCR/L 11

25 300 46 23 17 32 -3° 0°

DCGT



93°

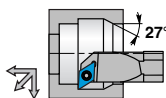

$\gamma_n = \dots$

$\lambda_s = \dots$

κ_r – kąt przystawienia, γ_n – kąt natarcia, λ_s – kąt pochylenia / tool cutting edge angle / tool normal rake / tool cutting edge indication /

A..SSKCR/L

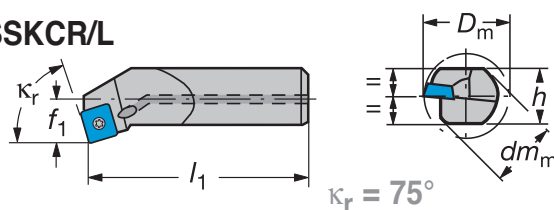

S

Zastosowanie
Application



Oznaczenie
Designation

dm_m l_1 h f_1 D_{mmin} λ_s
(mm) (mm) (mm) (mm) (mm) (°)

SCMT



75°

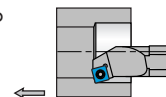

$\gamma_n = 0^\circ$

$\lambda_s = \dots$

09 A16R-SSKCR/L 09

16 200 15 11 20 -8°

A20S-SSKCR/L 09

20 250 18 13 25 -6°

12 A25T-SSKCR/L 12

25 300 23 17 32 -4,5°

A32T-SSKCR/L 12

32 300 30 22 40 -9°

SCGT

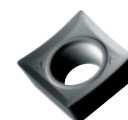

κ_r – kąt przystawienia, γ_n – kąt natarcia, λ_s – kąt pochylenia / tool cutting edge angle / tool normal rake / tool cutting edge indication /

Części zamienne
Spare parts



Śruba
Screw



Pł. podporowa
Shim



Śruba pł. podpor.
Shim screw



Klucz
Key



07

11

dla/for 20
dla/for 25

5513 020-03

5513 020-09

5513 020-10

–

–

–

–

–

–

5680 051-02 (7IP)

5680 049-01 (15IP)

5680 049-01 (15IP)



09

12

dla/for 25
dla/for 32

5513 020-09

5513 020-17

5513 020-18

–

–

5522 420-02

–

–

5512 090-03

5680 049-01 (15IP)

5680 049-02 (15IP)

5680 049-02 (15IP)

Przykład zamówienia / Ordering example: A10K-SDUCR 07 – 1 szt. / pcs

A..-STFCR/L

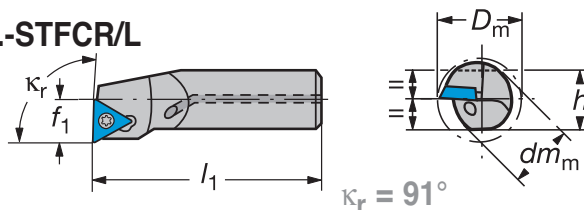

S

Zastosowanie
Application



Oznaczenie
Designation

dm_m l₁ h f₁ D_{mmin} λ_s
(mm) (mm) (mm) (mm) (mm) (°)

TCMT



91°

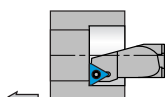

γ_n = 0°
λ_s = ...

11

A12M-STFCR/L 11-B1
A16R-STFCR/L 11-B1
A20S-STFCR/L 11-B1

12 150 11 9 16 -8°
16 200 15 11 20 -5°
20 250 18 13 25 -3°

16

A25T-STFCR/L 16
A32T-STFCR/L 16
A40T-STFCR/L 16

25 300 23 17 32 -3°
32 300 30 22 32 -7°
40 300 37 27 32 -4,5°

TCGT



A..-SVQBR/L

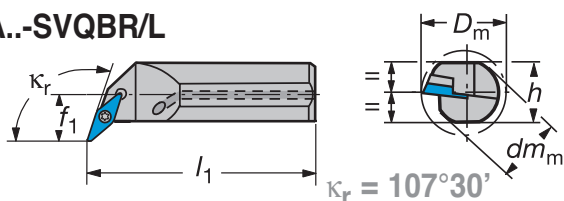

A..-SVUBR/L

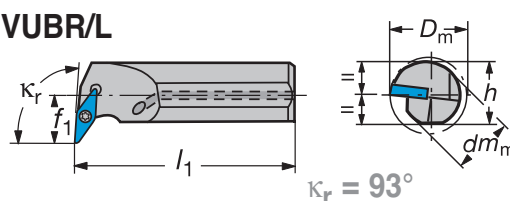

S

Zastosowanie
Application



Oznaczenie
Designation

dm_m l₁ h f₁ D_{mmin} λ_s
(mm) (mm) (mm) (mm) (mm) (°)

VBMT



107°30'

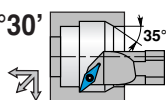

γ_n = 0°
λ_s = ...

11

A16R-SVQBR/L 11-EB1
A20S-SVQBR/L 11-EB1
A25T-SVQBR/L 11-DB1

16 200 15 13 22 -7°
20 250 18 15 27 -6°
25 300 23 18 33 -4°

16

A25T-SVQBR/L 16-D
A32U-SVQBR/L 16
A40V-SVQBR/L 16

25 300 23 18 33 -6°
32 350 30 22 40 -8°
40 400 37 27 50 -8°

VCGT



93°

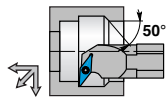

γ_n = 0°
λ_s = ...

11

A16R-SVUBR/L 11-EB1
A20S-SVUBR/L 11-EB1
A25T-SVUBR/L 11-DB1

16 200 15 13 22 -7°
20 250 18 15 27 -5°
25 300 23 18 33 -4°

16

A25T-SVUBR/L 16-D
A32T-SVUBR/L 16
A40T-SVUBR/L 16

25 300 23 18 33 -6,5°
32 300 30 22 40 -6°
40 300 37 27 50 -3,5°

κ_r – kąt przystawienia, γ_n – kąt natarcia, λ_s – kąt pochylenia / tool cutting edge angle / tool normal rake / tool cutting edge indication /

Części zamienne
Spare parts



Śruba
Screw



Pł. podporowa
Shim



Śruba pł. podpor.
Shim screw



Klucz
Key



11

16

dla/for 25
dla/for 32-40

5513 020-03
5513 020-10
5513 020-01

5322 320-01

5512 090-01

5680 051-02 (7IP)
5680 049-01 (15IP)
5680 049-01 (15IP)



11

16

dla/for 25
dla/for 32-40

5513 020-03
5513 020-10
5513 020-01

5322 270-01

5512 090-01

5680 051-02 (7IP)
5680 049-01 (15IP)
5680 049-01 (15IP)

Przykład zamówienia / Ordering example: A12M-STFCR 11-B1 – 1 szt. / pcs

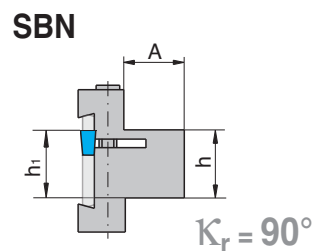
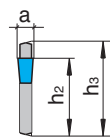
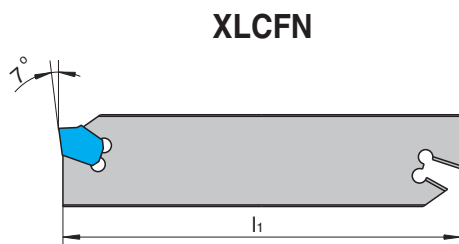

Zastosowanie
Application



Listwa
Blade

h₃ (mm) l₁ (mm) h₂ (mm) D_{mmax} (mm) a (mm)

90°

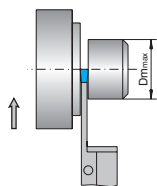

2	XLCFN 1902G22	19	90	15,7	30	2,2
	XLCFN 2602J22-FX	26	110	21,4	40	2,2
	XLCFN 3202M22-FX	32	150	25,0	40	2,2
3	XLCFN 2603J31-FX	26	110	21,4	75	3,1
	XLCFN 3203M31-FX	32	150	25,0	100	3,1
4	XLCFN 2604J41-FX	26	110	21,4	75	4,1
	XLCFN 3204M41-FX	32	150	25,0	100	4,1
5	XLCFN 3205M51-FX	32	150	25,0	100	5,1

LFMX

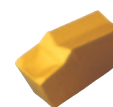

Imak blokowy
Tool block

h=h₁ (mm) A (mm)

2	SBN 1616-19	16	16
2, 3, 4	SBN 2019-26	20	19
2, 3, 4, 5	SBN 2019-32	20	19
2, 3, 4, 5	SBN 2520-32	25	20
2, 3, 4, 5	SBN 3228-32	32	28

K_r – kąt przystawienia / tool cutting edge angle

Części zamienne Spare parts



Płytki
Insert

Listwa
Blade

Imak blokowy
Tool block



Klucz płytki
Insert key



Śruba
Screw



Klucz
Key

2	LFMX 2R	XLCFN 1902G22	SBN 1616-19	150.19-130	M520	KI 04
		XLCFN 2602J22-FX	SBN 2019-26	150.19-130	M630	KI 05
		XLCFN 3202M22-FX	SBN 2019-32	150.19-130	M630	KI 05
			SBN 2520-32	150.19-130	M630	KI 05
			SBN 3228-32	150.19-130	M630	KI 05
3	LFMX 3N	XLCFN 2603J31-FX	SBN 2019-26	150.19-130	M630	KI 05
		XLCFN 3203M31-FX	SBN 2019-32	150.19-130	M630	KI 05
			SBN 2520-32	150.19-130	M630	KI 05
			SBN 3228-32	150.19-130	M630	KI 05
4	LFMX 4N	XLCFN 2604J41-FX	SBN 2019-26	150.19-130	M630	KI 05
		XLCFN 3204M41-FX	SBN 2019-32	150.19-130	M630	KI 05
			SBN 2520-32	150.19-130	M630	KI 05
			SBN 3228-32	150.19-130	M630	KI 05
5	LFMX 5N	XLCFN 3205M51-FX	SBN 2019-32	150.19-130	M630	KI 05
			SBN 2520-32	150.19-130	M630	KI 05
			SBN 3228-32	150.19-130	M630	KI 05

Przykład zamówienia / Ordering example: XLCFN 2602J22-FX – 1 szt. / pcs
+ imak blokowy: / tool block: SBN 2019-26 – 1 szt. / pcs

P61.SFR/L

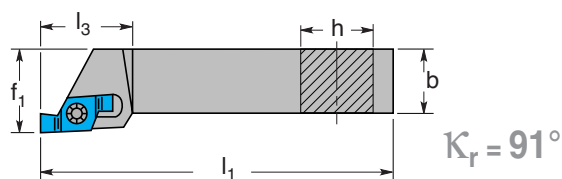

zewnętrzne / external

Zastosowanie
Application



Oznaczenie
Designation

b (mm) h (mm) l1 (mm) l3 (mm) f1 (mm)

91°

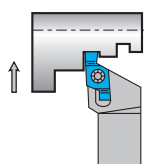

06

P61.SFR/L-1616H-06
P61.SFR/L-2020K-06
P61.SFR/L-2525M-06

16 16 100 21 20
20 20 125 25 25
25 25 150 32 32

09

P61.SFR-2020K-09
P61.SFR/L-2525M-09

20 20 125 25 25
25 25 150 32 32

X61..R/L
X61..R..R/L



P61.SGR/L

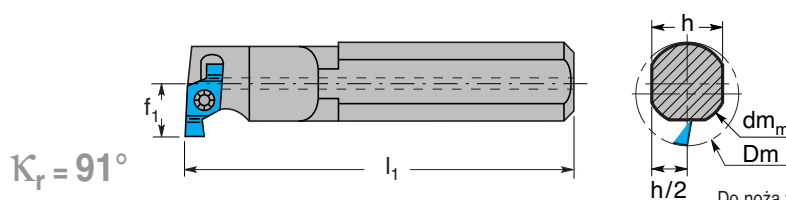

wewnętrzne / internal

Zastosowanie
Application



Oznaczenie
Designation

dm_min (mm) h (mm) l1 (mm) f1 (mm) Dm_min (mm)

91°

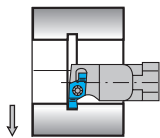

06

P61.SGR/L-0012M-06
P61.SGR/L-A-0016M-06
P61.SGR/L-A-0020P-06
P61.SGR/L-A-0025R-06
P61.SGR/L-A-0032T-06

12 11 150 9 16
16 15 150 11 20
20 18 170 13 25
25 23 200 17 32
32 30 300 22 40

09

P61.SGR-A-0020P-09

20 18 170 13 25

X61..R/L
X61..R..R/L

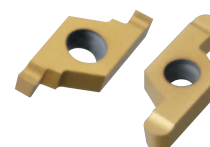

Do noża w wersji prawej stosować płytkę lewą.
With a right-hand toolholder use a left-hand insert.

Kr – kąt przystawienia / tool cutting edge angle

Części zamienne
Spare parts



Śruba
Screw



Klucz
Key



Pł. podporowa
Shim



Śruba pł. podpor.
Shim screw



Klucz
Key



06

TORX-P-M2,5x6/7

MA2-8304

–

–

–

09

TORX-P-M3x10A/9

T9 MD703

PZ61-09 R/L

DVT0332

UNI 2415-2



06

TORX-P-M2,5x6/7

MA2-8304

–

–

–

09

TORX-P-M3x10A/9

T9 MD703

PZ61-09 R/L

–

–

P92.CXCBR/L

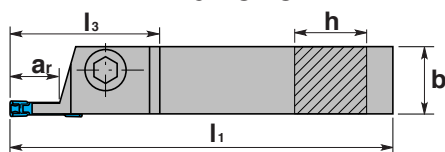

$K_r = 90^\circ$

zewnętrzne / external

Zastosowanie
Application



Oznaczenie
Designation

h b l1 l3 ar
(mm) (mm) (mm) (mm) (mm)

90°

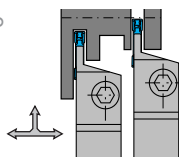

3
4
5

P92.CXCBR/L 2020M-30V
P92.CXCBR/L 2525M-30V
P92.CXCBR/L 2020M-40V
P92.CXCBR/L 2525M-40V
P92.CXCBR/L 2020M-50V
P92.CXCBR/L 2525N-50V

20 20 150 34 14
25 25 150 34 14
20 20 150 34 14
25 25 150 34 14
20 20 150 40 20
25 25 160 40 20



P92-S-CXCBR/L

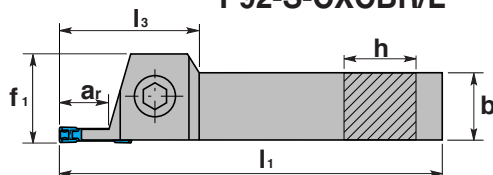

$K_r = 90^\circ$

zewnętrzne / external

Zastosowanie
Application



Oznaczenie
Designation

h b f1 l1 l3 ar
(mm) (mm) (mm) (mm) (mm) (mm)

90°

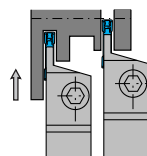

2

P92.S-CXCBR 0808 K20V
P92.S-CXCBR/L 1010 K20V
P92.S-CXCBR/L 1212 K20V
P92.S-CXCBR/L 1612 K20V
P92.S-CXCBR/L 2020 K20V
P92.S-CXCBL 2525 M20V

08 08 12 125 21 11
10 10 12 125 21 11
12 12 - 125 21 11
16 12 - 125 21 11
20 20 - 125 21 11
25 25 - 150 21 11

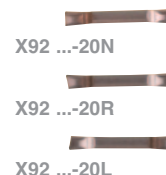

K_r – kąt przystawienia / tool cutting edge angle

Części zamienne
Spare parts



Nóż
Toolholder



Śruba
Screw



Klucz
Key

3, 4, 5

..2020M..
..2525M..

UNI 5931 M6x20
UNI 5931 M6x25

186-843
186-843

2

..0808..
..1010..
..1212..
..1612..
..2020..
..2525..

UNI 5931 M4x8
UNI 5931 M4x10
UNI 5931 M4x10
UNI 5931 M4x12
UNI 5931 M4x16
UNI 5931 M4x16

MA2-688
MA2-688
MA2-688
MA2-688
MA2-688
MA2-688

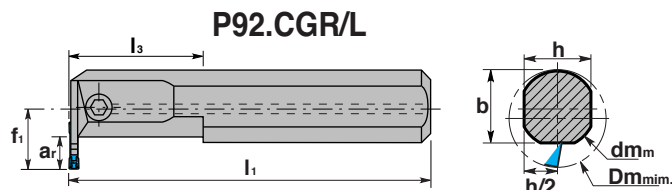

$K_r = 90^\circ$

wewnętrzne / internal

Zastosowanie
Application



Oznaczenie
Designation

dm_m h b f_1 l_1 l_3 $a_{r_{max}}$ $D_{m_{min}}$
(mm) (mm) (mm) (mm) (mm) (mm) (mm) (mm)

90°

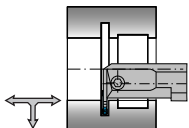

3

P92.CGR/L-A-0020R-30V
P92.CGR/L-A-0025R-30V

20 18 18 13 200 30 7 25
25 23 22,5 17 225 40 10 32

4

P92.CGR/L-A-0032S-30V
P92.CGR/L-A-0025R-40V

32 30 29,5 22 250 45 12 40
25 23 22,5 17 225 40 10 32

5

P92.CGR/L-A-0032S-40V
P92.CGR/L-A-0040T-40V
P92.CGR-A-0040T-50V

32 30 29,5 22 250 45 12 40
40 37 37,5 30 300 80 16 52
40 37 37,5 30 300 80 16 52



P92.CGR/L..-30C

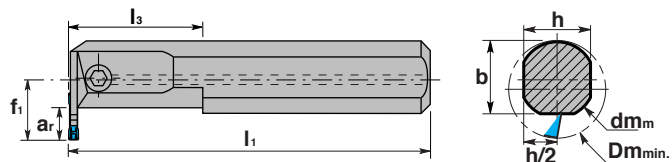

$K_r = 90^\circ$

wewnętrzne / internal

Zastosowanie
Application



Oznaczenie
Designation

dm_m h b f_1 l_1 l_3 $a_{r_{max}}$ $D_{m_{min}}$
(mm) (mm) (mm) (mm) (mm) (mm) (mm) (mm)

90°

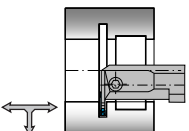

3

P92.CGR/L-0012M-30CV

12 11 11,5 9 150 22 3 15,5
5,5 18

P92.CGR/L-A-0016P-30CV

16 15 15,5 11 170 26 4,5 20
7 22,5



K_r – kąt przystawienia / tool cutting edge angle

Części zamienne
Spare parts



Nóż
Toolholder



Śruba
Screw



Klucz
Key

3

..0020R..
..0025R..
..0032S..

UNI 5931 M5x12
UNI 5931 M6x16
UNI 5931 M6x16

174.818
186-843
186-843

4

..0025R..
..0032S..
..0040T..

UNI 5931 M6x16
UNI 5931 M6x16
UNI 5931 M6x20

186-843
186-843
186-843

5

..0040T..

UNI 5931 M6x20

186-843

3

..0012M..
..0016M..

UNI 5931 M4x8
UNI 5931 M5x10

MA2-688
174.818

P92-2-CXCRC-.. + C92-RC-..

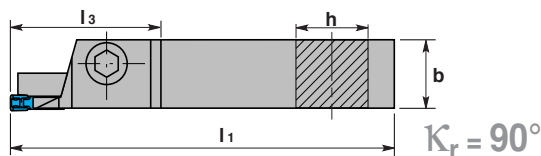

rowkowanie osiowe
axial grooving

Zastosowanie
Application



Oznaczenie
Designation

b l1 l3 h
(mm) (mm) (mm) (mm)

3

P92-2-CXCRC-2020M-30V
P92-2-CXCLC-2020M-30V
P92-2-CXCLC-2525N-30V

20 150 44 20
20 150 44 20
25 160 44 25

4

P92-2-CXCRC-2020M-40V
P92-2-CXCLC-2020M-40V
P92-2-CXCRC-2525N-40V
P92-2-CXCLC-2525N-40V

20 150 44 20
20 150 44 20
25 160 44 25
25 160 44 25



X92 200-30-V-N
X92 200-40-V-N



X92 200-30-V-S
X92 200-40-V-S

90°

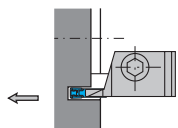

C92-RC

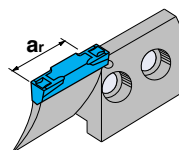
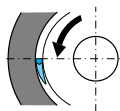

C92-LC

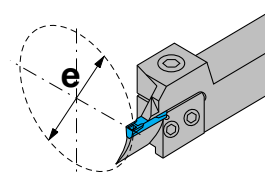
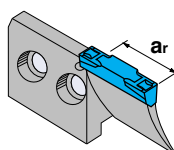

Kompletne narzędzie składa się z oprawki i wkładki.
A complete tool consist of a toolholder and a cartridge.

Wkładki prawe R
Right-hand cartridge R

E_{min-max} ar_{max}

C92-RC-3035-30	30 - 35	15
C92-RC-3542-30	35 - 42	15
C92-RC-4250-30	42 - 50	15
C92-RC-5058-30	50 - 58	15
C92-RC-5866-30	58 - 66	15
C92-RC-6675-30	66 - 75	15
C92-RC-75100-30	75 - 100	15
C92-RC-100200-30	100 - 200	15

Wkładki lewe L
Left-hand cartridge L

E_{min-max} ar_{max}

C92-LC-3035-30	30 - 35	15
C92-LC-3542-30	35 - 42	15
C92-LC-4250-30	42 - 50	15
C92-LC-5866-30	58 - 66	15
C92-LC-75100-30	75 - 100	15
C92-LC-100200-30	100 - 200	15

C92-RC-4254-40	42 - 54	15
C92-RC-5466-40	54 - 66	15
C92-RC-6680-40	66 - 80	15
C92-RC-80100-40	80 - 100	15
C92-RC-100200-40	100 - 200	15

C92-LC-5466-40	54 - 66	15
C92-LC-6680-40	66 - 80	15
C92-LC-80100-40	80 - 100	15
C92-LC-100200-40	100 - 200	15

K_r – kąt przystawienia / tool cutting edge angle

Części zamienne
Spare parts



Nóż
Toolholder



Śruba
Screw



Klucz
Key



Śruba
Screw



Klucz
Key



3, 4

..2020M..
..2525M..

UNI 5931 M6x20
UNI 5931 M6x20

186-843
186-843

N°2 - UNI 5931 M4x12
N°2 - UNI 5931 M4x12

MA2-688
MA2-688

Przykład zamówienia / Ordering example: P92-2-CXCRC-2020M-30V – 1 szt. / pcs
+ wkładka: / cartridge: C92-RC-3035-30 – 1 szt. / pcs

rowkowanie osiowe
axial grooving

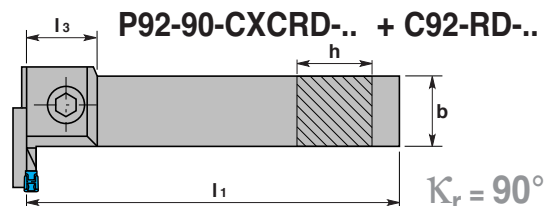
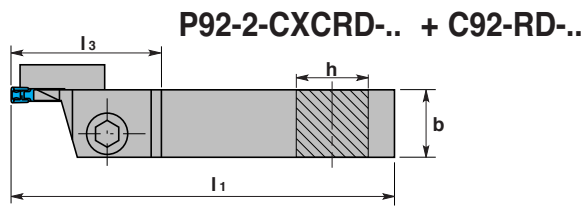

Zastosowanie
Application



Oznaczenie
Designation

b l1 l3 h
(mm) (mm) (mm) (mm)

90°

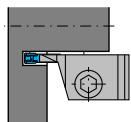

3

P92-2-CXCRD-2020M-30V

20 150 44 20

P92-2-CXCLD-2020M-30V

20 150 44 20

P92-2-CXCRD-2525N-30V

25 160 44 25

P92-2-CXCLD-2525N-30V

25 160 44 25

4

P92-2-CXCRD-2020M-40V

20 150 44 20

P92-2-CXCRD-2525N-40V

25 160 44 25

P92-2-CXCLD-2525N-40V

25 160 44 25



X92 200-30-V-N
X92 200-40-V-N

90°

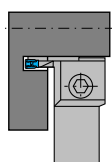

3

P92-90-CXCRD-2525N-30V

25 160 44 25

P92-90-CXCLD-2525N-30V

25 160 44 25

4

P92-90-CXCRD-2525N-40V

25 160 44 25

P92-90-CXCLD-2525N-40V

25 160 44 25

X92 200-30-V-S
X92 200-40-V-S

C92-RD

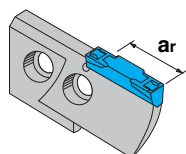

C92-LD

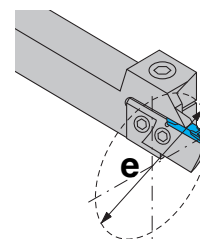
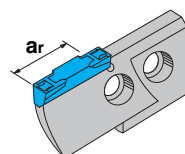

Kompletne narzędzie składa się z oprawki i wkładki.
A complete tool consist of a toolholder and a cartridge.

Wkładki prawe R
Right-hand cartridge R

E_{min-max} a_{rmax}

Wkładki lewe L
Left-hand cartridge L

E_{min-max} a_{rmax}

C92-RD-3035-30
C92-RD-3542-30
C92-RD-4250-30
C92-RD-5058-30
C92-RD-5866-30
C92-RD-6675-30
C92-RD-75100-30
C92-RD-100200-30

30 - 35 15
35 - 42 15
42 - 50 15
50 - 58 15
58 - 66 15
66 - 75 15
75 - 100 15
100 - 200 15

C92-LD-3035-30
C92-LD-3542-30
C92-LD-4250-30
C92-LD-5058-30
C92-LD-5866-30
C92-LD-6675-30
C92-LD-75100-30
C92-LD-100200-30

30 - 35 15
35 - 42 15
42 - 50 15
50 - 58 15
58 - 66 15
66 - 75 15
75 - 100 15
100 - 200 15

C92-RD-4254-40
C92-RD-5466-40
C92-RD-6680-40
C92-RD-80100-40
C92-RD-100200-40

42 - 54 15
54 - 66 15
66 - 80 15
80 - 100 15
100 - 200 15

C92-LD-4254-40
C92-LD-5466-40
C92-LD-6680-40
C92-LD-80100-40
C92-LD-100200-40

42 - 54 15
54 - 66 15
66 - 80 15
80 - 100 15
100 - 200 15

K_r – kąt przystawienia / tool cutting edge angle

Części zamienne
Spare parts



Nóż
Toolholder

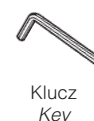
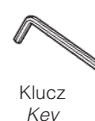

3, 4

..2020M..
..2525M..

UNI 5931 M6x20
UNI 5931 M6x20

186-843
186-843

N°2 - UNI 5931 M4x12
N°2 - UNI 5931 M4x12

MA2-688
MA2-688

Przykład zamówienia / Ordering example: P92-2-CXCRD-2020M-30V – 1 szt. / pcs
+ wkładka: / cartridge: C92-RD-3035-30 – 1 szt. / pcs



PŁYTKI DO FREZOWANIA

INSERTS FOR MILLING

str. / page: rozdział / chapter:

- E2 **Oznaczenie płytek do frezowania**
Designation of inserts for milling
- E4 **Płytki do frezowania**
Inserts for milling
- E10 **Płytki do frezowania – narzędzia QUADRI i ECO 45**
Inserts for milling – QUADRI and ECO 45 tools
- E12 **Płytki do frezów tarczowych**
Inserts for slitting cutters
- E13 **Płytki do wiercenia**
Inserts for drilling
- E14 **Płytki podporowe**
Shims

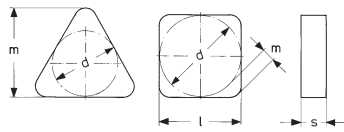

S

P

K

N

12

1. Kształt płytki i kąt naroża ϵ_r

Insert shape and angle ϵ_r

2. Kąt przyłożenia normalny α_n

Normal clearance angle α_n

3. Dokładność płytki

Tolerance class

4. Kształt powierzchni natarcia i sposób mocowania płytki
Chipbreaker and clamping type

5. Długość boku płytki

Edge length

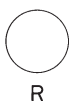
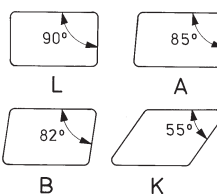
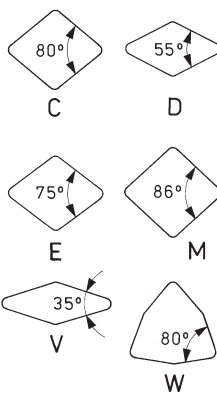
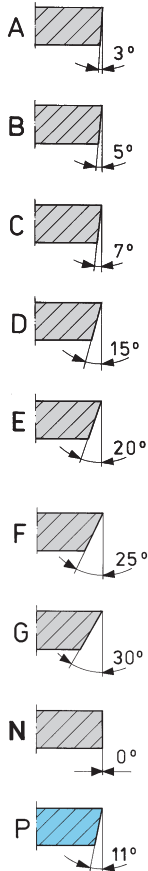
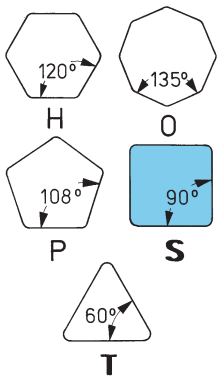
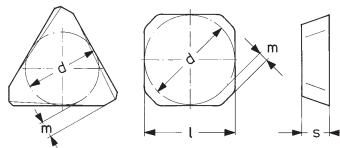
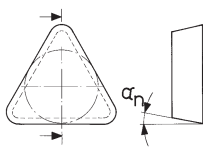

O – inne
others

Tolerancja (mm) Tolerance		
l(d)	m	s
±0,025	±0,005	±0,025
A ¹⁾		
±0,013	±0,005	±0,025
F ¹⁾		
±0,025	±0,013	±0,025
C ¹⁾		
±0,013	±0,013	±0,025
H		
±0,025	±0,025	±0,025
E		
±0,025	±0,025	±0,13
G		
±0,05 ±0,15 ²⁾	±0,005	±0,025
J ¹⁾		
±0,05 ±0,15 ²⁾	±0,013	±0,025
K ¹⁾		
±0,05 ±0,15 ²⁾	±0,025	±0,025
L ¹⁾		
±0,05 ±0,15 ²⁾	±0,08 ±0,20 ²⁾	±0,13
M		
±0,05 ±0,15 ²⁾	±0,08 ±0,20 ²⁾	±0,025
N		
±0,08 ±0,25 ²⁾	±0,13 ±0,38 ²⁾	±0,13
U		

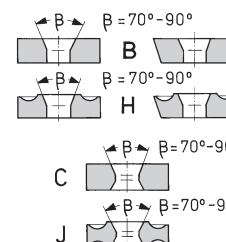
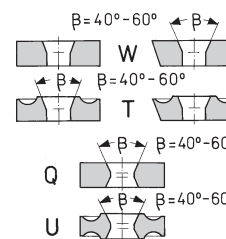
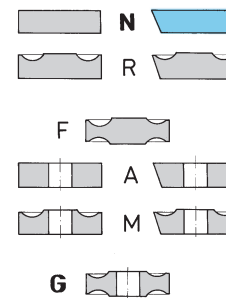

X – wykonanie specjalne
tailor-made inserts

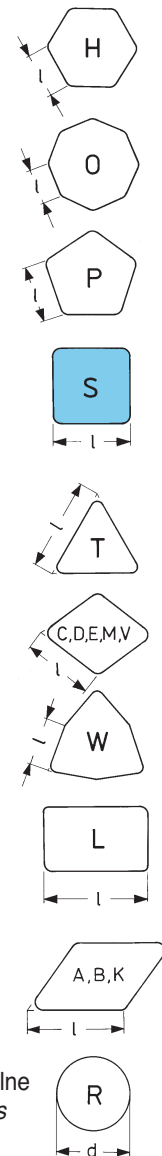

1) Odchyłki te stosuje się dla płytek szlifowanych ze ścinami
These tolerance classes apply to ground indexable inserts with wiper edge
2) Wartości odchyłek (od-do) w zależności od wielkości „d”
Values of deviations (from-to) according to insert size „d”

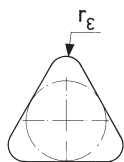

7. Promień naroża r_e
Corner radius r_e

Symbol	r_e (mm)
00	<0,2
02	0,2
04	0,4
08	0,8
24	2,4
x	inne others
00 MO	dla płytek okrągłych for round inserts

03 ED S R

6. Grubość płytki
Insert thickness

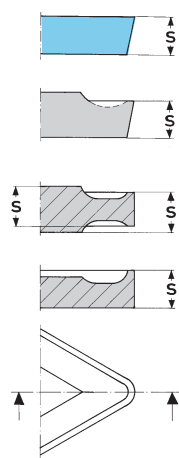

7. Kształt naroża płytki ze ścinami
Insert with wiper edges

Pierwsza litera określa kąt przystawienia K_r
First letter indicate cutting edge angle K_r

Druga litera określa normalny kąt przyłożenia ścinu krawędzi skrawającej pomocniczej α'_1
Second letter indicates wiper edge normal clearance α'_1

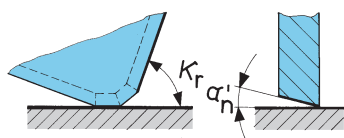

8. Postać krawędzi skrawającej
Cutting edge condition

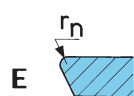

– zaokrąglona / rounded
 $r_n \geq 0,02$ mm



– ze ścinem i zaokrąglona
chamfered and rounded



– ostra / sharp
 $r_n < 0,02$ mm



– ze ścinem / chamfered

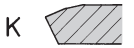

– z podwójnym ścinem
double chamfered



– z podwójnym ścinem i zaokrąglona
double chamfered and rounded

9. Kierunek skrawania
Cutting direction

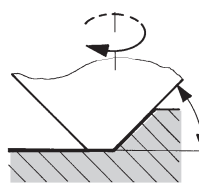
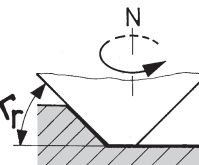
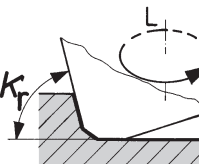
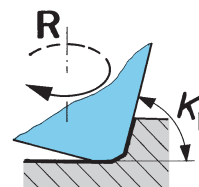

10. Symbol ustalony przez producenta np. geometria łamacza wiórów

Manufacturer's optional symbol e.g. chipbreaker geometry

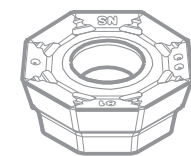

Symbols	(mm)
01	1,59
T1	1,98
02	2,38
03	3,18
T3	3,97
04	4,76
05	5,56
06	6,35
07	7,94
09	9,52
12	12,70

Symbol	K_r
A	= 45°
D	= 60°
E	= 75°
F	= 85°
P	= 90°
Z	= inne
others	others

Symbol	α'_1
A	= 3°
B	= 5°
C	= 7°
D	= 15°
E	= 20°
F	= 25°
G	= 30°
N	= 0°
P	= 11°
Z	= inne
others	others

Symboly dodatkowe
Additional symbols

d (mm)	Płytki okrągłe Round inserts
	R
5,0	05
6,0	06
8,0	08
9,525	09
10,0	10
12,0	12
12,70	12
15,875	15
16,0	16
19,05	19
20,0	20
25,0	25
25,4	25
31,75	31
32,0	32

l (d) (mm)	Tolerancje Tolerances mm					
	for l (d)			for m		
	Dokładność płytki Tolerance class					
	J,K,L,M,N	U	M i N	U i M	M	
Kształt płytki Insert shape						
H,O,P,S,T,C,D,E,M,W,R			H,O,P,S,T,C,E,N,W,R			
D						
4,76						
5,56						
6,35 (6)	±0,05	±0,08	±0,08	±0,13	±0,11	
7,94 (8)						
9,525 (10)						
12,7 (12)	±0,08	±0,13	±0,13	±0,20	±0,15	
15,875 (16)						
19,05 (20)	±0,10	±0,18	±0,15	±0,27	±0,18	
25,4 (25)	±0,13	±0,25	±0,18	±0,38		
31,75 (32)	±0,15	±0,25	±0,20	±0,38		

Uzupełnienie do punktu 3

Supplement to point 3

Uzupełnienie do punktu 5 Supplement to point 5

l (d) (mm)	Symbol literowy określający kształt płytki Symbol for insert shape													
	H	O	P	S	T	C	D	E	M	V	W			
	4,76	-	-	-	04	08	04	05	04	04	08	-		
5,56	-	-	-	05	09	05	06	05	05	09	03			
6,35	03	02	04	06	11	06	07	06	06	11	04			
7,94	04	03	05	07	13	08	09	08	07	13	05			
9,525	05	04	07	09	16	09	11	09	09	16	06			
12,70	07	05	09	12	22	12	15	13	12	22	08			
15,875	09	06	11	15	27	16	19	16	15	27	10			
19,05	11	07	13	19	33	19	23	19	19	33	13			
25,40	14	10	18	25	44	25	31	26	25	44	17			
31,75	18	13	23	31	54	32	38	32	31	54	21			



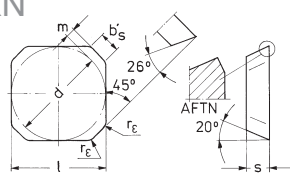

SEAN
SEGN
SEKN
SEKR
SNKN
SNHN

SEKN

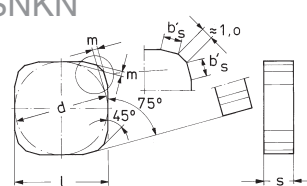

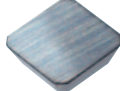
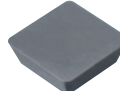
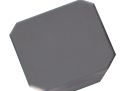
SNKN

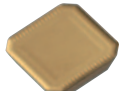
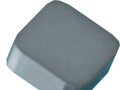

	Oznaczenie Designation	l=d (mm)	s (mm)	r _e (mm)	m (mm)	b' _s (mm)	gatunki / grades								
							CVD			PVD			HW		
							NMP20	NMK20	NMK30	N210	N250	N300	N350	SM25T	H10S
	12 SEAN 1203AFTN ¹⁾ SEAN 1203AFN 15 SEAN 1504AFTN ²⁾ SEAN 1504AFN	12,70 12,70 15,875 15,875	3,18 3,18 4,76 4,76	1,20 1,20 1,20 1,20	1,50 1,50 2,15 2,15	~2,30 ~2,30 ~2,30 ~2,30	○ ○ ○ ○							○ ○ ● ○	○ ○ ○ ○
	09 SEGN 090308 12 SEGN 120304 SEGN 120312	9,525 12,70 12,70	3,18 3,18 3,18	0,80 0,40 1,20	1,644 2,466 2,137	- - -								○ ● ●	
	12 SEKN 1204AZN SEKN 1204AZTN ³⁾	12,70 12,70	4,76 4,76	1,20 1,20	1,55 1,55	~2,30 ~2,30				○ ○			○ ●	○ ○	
	12 SEKN 1203AFTN ⁴⁾ SEKN 1203AFN 15 SEKN 1504AFTN ⁵⁾ SEKN 1504AFN	12,70 12,70 15,875 15,875	3,18 3,18 4,76 4,76	2,40 2,40 2,40 2,40	1,50 1,50 2,15 2,15	~1,60 ~1,60 ~1,60 ~1,60	○ ○ ○ ○			● ● ● ○			● ○ ○ ○	○ ○	
	12 SEKR 1203AFN	12,70	3,18	2,40	1,50	~1,60	●			●			○	○	
	12 SNKN 1204ENN	12,70	4,76	-	0,80	~1,50							●	○	○
	12 SNHN 1204ENEN 15 SNHN 1504ENEN	12,70 15,875	4,76 4,76	- -	0,95 1,30	~1,50 ~1,50	○ ○			○ ●			○ ○	○ ○	

Krawędź ze ściem / Chamfered edge

¹⁾ T = 0,15 x 20°

²⁾ T = 0,15 x 20°

³⁾ T = 0,20 x 25°

⁴⁾ T = 0,15 x 20°

⁵⁾ T = 0,15 x 20°

Przykład zamówienia / Ordering example: SEAN 1203AFTN, NMP20 – 10 szt. / pcs

CVD, PVD (HC) - gatunek pokrywany / coated grade
(HW) - gatunek niepokrywany / uncoated grade

● - pierwszy wybór / first choice

Inserts for milling

**SPAN
SPKN
SPKR
LPKN**

SPKN ..R

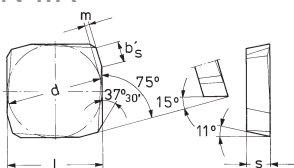

SPKR ..R

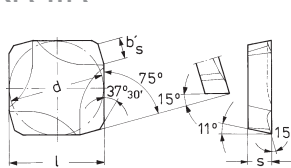

LPKN ..R

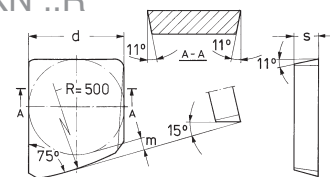

		Oznaczenie Designation	l=d (mm)	s (mm)	m (mm)	b's (mm)	gatunki / grades													
							CVD			PVD			HW							
							NMP20	NMK20	NMK30	N210	N250	N300	N350	SM25T	H10S	H15X	H20S			
	12	SPAN 1203EDR	12,70	3,18	0,88	~1,40												●	○	○
	15	SPAN 1504EDR	15,875	4,76	1,26	~1,40												○	○	○
	12	SPKN 1203EDR	12,70	3,18	0,88	~1,40												○	○	○
		SPKN 1203EDL	12,70	3,18	0,92	~1,40	○	○		●	●	●	●	●	○	●	○	○	○	
	15	SPKN 1504EDR	15,875	4,76	1,26	~1,40	○	○		●	●	●	●	●	○	●	○	○	○	
		SPKN 1504EDL	15,875	4,76	1,26	~1,40	○	○		●	●	●	●	●	○	●	○	○	○	
	12	SPKN 1203EDTR ¹⁾	12,70	3,18	0,90	~1,40	●									●		○		
	12	SPKR 1203EDR	12,70	3,18	-	~1,40												●	●	○
		SPKR 1203EDL	12,70	3,18	-	~1,40												●	○	
	12	SPKR 1203EDR-PR1	12,70	3,18	0,872	~1,60				●	●		●	●	○					
		Oznaczenie Designation	d (mm)	s (mm)	m (mm)															
	12	LPKN 1203ZZR	12,70	3,18	0,96													○	○	

Krawędź ze ściemem / Chamfered edge

¹⁾ T = 0,35 x 10°

Przykład zamówienia / Ordering example: SPAN 1203EDR, SM25T – 10 szt. / pcs

CVD, PVD (HC) - gatunek pokrywany / coated grade
 (HW) - gatunek niepokrywany / uncoated grade

● - pierwszy wybór / first choice

Płytki do frezowania

Inserts for milling

TPAN
TPKN
TPKR

TPAN

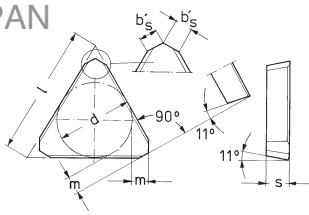

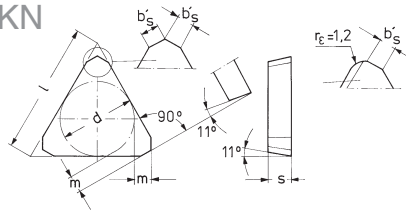

TPKN

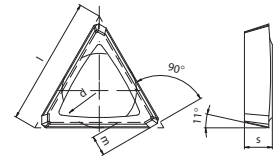

TPKR ..PR1

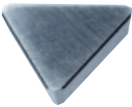
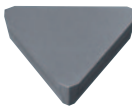
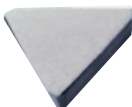

	Oznaczenie Designation	l (mm)	d (mm)	s (mm)	m (mm)	b' _s (mm)	gatunki / grades												
							CVD			PVD			HW						
							NMP20	NMK20	NMK30	N210	N250	N300	N350	SM25T	H10S	H15X	H20S		
	16 TPAN 1603PPN	16,5	9,525	3,18	2,40	~1,20				○		●							
	16 TPKN 1603PPN 22 TPKN 2204PPN	16,5 22,0	9,525 12,70	3,18 4,76	2,40 3,48	~1,20 ~1,50	○							○					
	16 TPKN 1603PPL 22 TPKN 2204PPL	16,5 22,0 22,0	9,525 12,70 12,70	3,18 4,76 4,76	2,40 3,48 3,48	~1,00 ~1,50 ~1,50	○	●	○	●	●	●	●	○	●	○	○	○	○
	16 TPKR 1603PDR-PR1 22 TPKR 2204PDR-PR1	16,5 22,0	9,525 12,70	3,18 4,76	2,42 3,465	~1,23 ~1,26		○	●	●	●	●	○						

Przykład zamówienia / Ordering example: TPAN 1603PPN, SM25T – 10 szt. / pcs

CVD, PVD (HC) - gatunek pokrywany / coated grade
(HW) - gatunek niepokrywany / uncoated grade

● - pierwszy wybór / first choice

TPKN TEGN

TPKN ..R

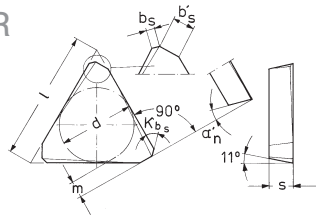

TEGN

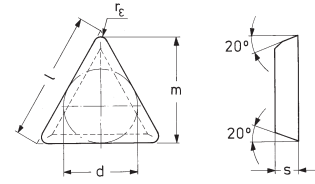

				gatunki / grades										
				CVD		PVD			HW					
				NMP20	NMK20	NMK30	N210	N250	N300	N350	SM25T	H10S	H15X	H20S
		Oznaczenie Designation	l (mm)	d (mm)	s (mm)	m (mm)	b _s (mm)	b' _s (mm)	K _{ps} (°)	α' _n (°)				
	16	TPKN 1603PPR-A	16,5	9,525	3,18	2,40	~1,00	~1,20	30	11				○
	22	TPKN 2204PDR TPKN 2204PDTR ¹⁾	22,0	12,70	4,76	3,48	~0,70	~1,40	45	15	○		●	○ ○ ○ ○ ○ ○
			22,0	12,70	4,76	3,48	~0,70	~1,40	45	15			○	○ ○ ○ ○ ○ ○
		Oznaczenie Designation	l (mm)	d (mm)	s (mm)	m (mm)	r _e (mm)							
	11	TEGN 110304	11	6,35	3,18	9,128	0,4						○ ○ ○ ○ ○ ○	
		TEGN 110308	11	6,35	3,18	8,731	0,8						○ ○ ○ ○ ○ ○	
	16	TEGN 160308	16,5	9,525	3,18	13,494	0,8						○ ○ ○ ○ ○ ○	

Krawędź ze ścinem. / Chamfered edge

¹⁾ T = 0,20 x 20°

Przykład zamówienia / Ordering example: TPKN 1603PPR-A, SM25T – 10 szt. / pcs

CVD, PVD (HC) - gatunek pokrywany / coated grade
(HW) - gatunek niepokrywany / uncoated grade

● - pierwszy wybór / first choice

Płytki do frezowania

Inserts for milling

ADMT
ADMW
APFT
APKW
CCMX
RPHT

ADMW ..R

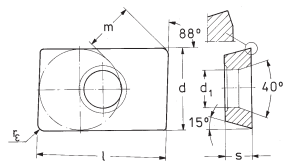

APFT ..R

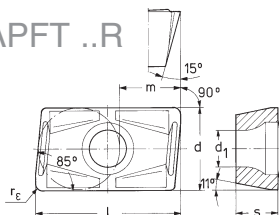

CCMX

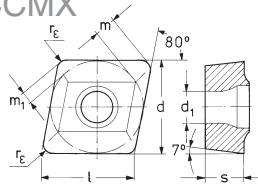

RPHT

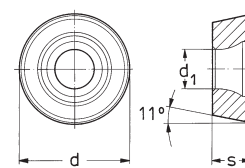

	Oznaczenie Designation	l (mm)	d (mm)	s (mm)	r _E (mm)	d ₁ (mm)	m (mm)	gatunki / grades												
								CVD			PVD			HW						
								NMP20	NMK20	NMK30	N210	N250	N300	N350	SM25T	H10S	H15X	H20S		

	15	ADMT 150308TR ¹⁾	15	9,525	3,18	0,8	4,4	5,683												
	15	ADMW 150308R ADMW 150308TR ²⁾	15	9,525	3,18	0,8	4,4	5,683												
	16	APFT 1604PDTR ³⁾	17	9,525	4,76	0,8	4,4	7,21												
	16	APFT 1604PDTR-PM1	17	9,525	5,56	0,8	4,4	7,21												
	16	APKW 160430TR ⁴⁾ APKW 160450R	17	9,525	4,76	3,0	4,4	6,03												

	Oznaczenie Designation	l (mm)	d (mm)	s (mm)	r _E (mm)	d ₁ (mm)	m (mm)	m ₁ (mm)	gatunki / grades											
									NMP20	NMK20	NMK30	N210	N250	N300	N350	SM25T	H10S	H15X	H20S	
	06	CCMX 060204	6,4	6,35	2,38	0,4	2,5	1,543	0,848											
	08	CCMX 080308	8,1	7,94	3,18	0,8	2,9	1,765	0,970											
	09	CCMX 09T308	9,7	9,525	3,97	0,8	3,4	2,206	1,212											
	12	CCMX 120408	12,9	17,70	4,76	0,8	3,8	3,088	1,697											

	Oznaczenie Designation	d (mm)	s (mm)	d ₁ (mm)	gatunki / grades															
					NMP20	NMK20	NMK30	N210	N250	N300	N350	SM25T	H10S	H15X	H20S					
	08	RPHT 0803MOT ⁵⁾	8,0	3,18	3,4															
	10	RPHT 10T3MOT ⁶⁾	10,0	3,97	4,4															
	12	RPHT 1204MO	12,0	4,76	4,4															

Krawędź ze ścinem. / Chamfered edge

- ¹⁾ T = 0,10 x 30°
- ²⁾ T = 0,15 x 20°
- ³⁾ T = 0,40 x 90°
- ⁴⁾ T = 0,20 x 20°
- ⁵⁾ T = 0,14 x 7°
- ⁶⁾ T = 0,12 x 7°

Przykład zamówienia / Ordering example: ADMT 150308TR, NMP20 – 10 szt. / pcs

CVD, PVD (HC) - gatunek pokrywany / coated grade
(HW) - gatunek niepokrywany / uncoated grade

● - pierwszy wybór / first choice

Płytki do frezowania

Inserts for milling

SEHX
SPMT
SPMW
SPMX
TCMT

SEHX

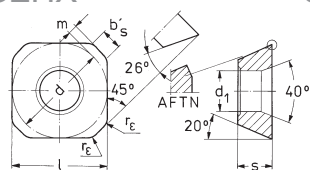

SPMW

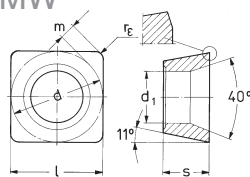

SPMX

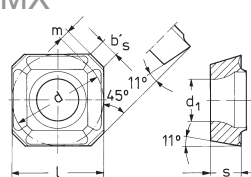

TCMT

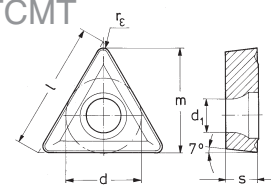

	Oznaczenie Designation	l=d (mm)	s (mm)	r _E (mm)	d ₁ (mm)	m (mm)	b' _s (mm)	gatunki / grades								
								CVD			PVD			HW		
								NMP20	NMK20	NMK30	N210	N250	N300	N350	SM25T	H10S
	12 SEHX 1204AFTN ¹⁾ SEHX 1204AFN	12,70 12,70	4,76 4,76	1,20 1,20	5,70 5,70	1,50 1,50	~2,30 ~2,30	○ ●							● ●	●
	12 SPMW 120408 SPMW 120408T ¹⁾	12,70 12,70	4,76 4,76	0,8 0,8	5,5 5,5	2,301 2,301	– –	○							● ●	●
	06 09 SPMX 0602AP SPMX 0903AP	6,35 9,525	2,38 3,18	– –	2,5 3,4	0,825 1,25	~1,0 ~1,45	○			○				○	
	16 TCMT 16T304 TCMT 16T308	16,5 16,5	9,525 9,525	3,97 3,97	0,4 0,8	4,4 4,4	13,891 13,494	○							○ ○	○
	22 TCMT 220408-11	22,0	12,70	4,76	0,8	5,5	18,256	○							●	○

Krawędź ze ściem. / Chamfered edge

¹⁾ T = 0,15 x 20°

Przykład zamówienia / Ordering example: SEHX 1204AFTN, SM25T – 10 szt. / pcs

CVD, PVD (HC) - gatunek pokrywany / coated grade
(HW) - gatunek niepokrywany / uncoated grade

● - pierwszy wybór / first choice

Inserts for milling - for QUADRI and ECO 45 tools





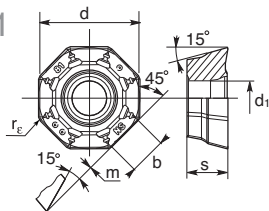

ODKT
ODMT
RDGT
RDMT

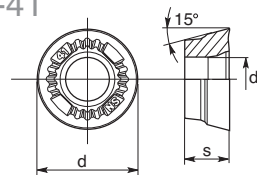
ODMT ..-81

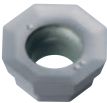

RDGT ..-41



	Oznaczenie Designation	d (mm)	s (mm)	r _e (mm)	d ₁ (mm)	m (mm)	b (mm)	gatunki / grades			
								CVD	PVD		
								5135	5020	5040	2003
	12 ODKT 1205AD FR-11	12,70	5,56	0,8	5,5	0,011	5,26				●
	12 ODKT 1205AD SR-41	12,70	5,56	0,8	5,5	0,011	5,26	●	●		●
	15 ODKT 1506AD SR-41	15,875	6,35	0,8	5,5	0,014	6,58	●			●
	12 ODMT 120508 SN-81	12,70	5,56	0,8	5,5	-	5,26	●	●		
	15 ODMT 150608 SN-81	15,875	6,35	0,8	5,5	-	6,58	●			
	12 RDGT 120500 FN-11	12,70	5,56	-	5,5						●
	12 RDGT 120500 SN-F8-41	12,70	5,56	-	5,5				●		
	12 RDMT 120500 SN-F8-81	12,70	5,56	-	5,5			●	●		
	15 RDMT 150600 SN-81	15,875	6,35	-	5,5						

Przykład zamówienia / Ordering example: ODKT 1205AD FR-11, 2003 – 10 szt. / pcs

CVD, PVD (HC) - gatunek pokrywany / coated grade
(HW) - gatunek niepokrywany / uncoated grade

● - pierwszy wybór / first choice

Inserts for milling - for QUADRI and ECO 45 tools

SDKT
SDMT

SDMT ..-81

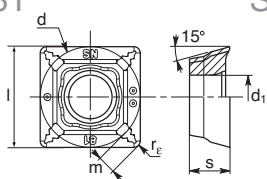

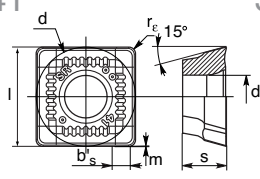

SDKT ..-41

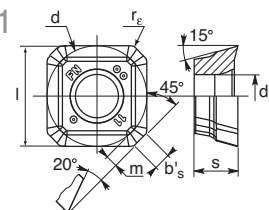

SDKT ..-11

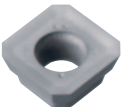

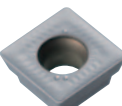
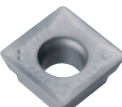
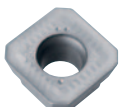
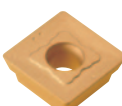
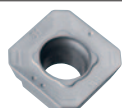
	Oznaczenie Designation	l=d (mm)	s (mm)	r _ε (mm)	d ₁ (mm)	m (mm)	b' _s (mm)	gatunki / grades				
								CVD	PVD		KX20	
								5135	5020	5040	2003	KX20
	12 SDKT 1205AE FN-11	12,70	5,56	0,8	5,5	1,43	2,18					●
	12 SDKT 1205AE SN-41	12,70	5,56	0,8	5,5	1,43	2,2	●	●			●
	12 SDKT 1205PD SR-41	12,70	5,56	0,8	5,5	0,028	2,3	●	●			
	12 SDMT 120508 EN-21 15 SDMT 150608 EN-21	12,70 15,875	5,56 6,35	0,8 0,8	5,5 5,5	2,301 2,958	– –	●	●			●
	12 SDMT 1205AE EN-21	12,70	5,56	0,8	5,5	1,43	1,7	●	●			
	12 SDMT 120508 SN-81 15 SDMT 150608 SN-81	12,70 15,875	5,56 6,35	0,8 0,8	5,5 5,5	2,301 2,958	– –	●	●			
	12 SDMT 1205AE SN-81 15 SDMT 1506AE SN-81	12,70 15,875	5,56 6,35	0,8 0,8	5,5 5,5	1,43 2,0	1,7 1,92	●	●		●	●

Przykład zamówienia / Ordering example: SDKT 1205AE FN-11, 2003 – 10 szt. / pcs

CVD, PVD (HC) - gatunek pokrywany / coated grade

(HW) - gatunek niepokrywany / uncoated grade

● - pierwszy wybór / first choice

LFMX

LFMX ..N

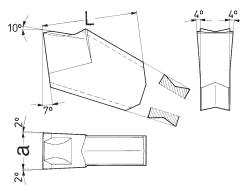

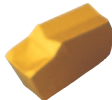
		Oznaczenie <i>Designation</i>	a (mm)	L (mm)	gatunki / grades			
					PVD	HW		
					N435	SM25T	H15X	H20S
	3	LFMX 3N	3,1	11,0	●	○	○	○
	4	LFMX 4N	4,1	11,0	○	○	○	○
	5	LFMX 5N	5,1	11,0	○	○	○	○



Przykład zamówienia / *Ordering example*: LFMX 3N, N435 – 10 szt. / pcs

CVD, PVD (HC) - gatunek pokrywany / coated grade
 (HW) - gatunek niepokrywany / uncoated grade

● - pierwszy wybór / *first choice*

WCMX

WCMX

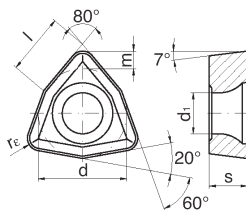

	Oznaczenie Designation	l (mm)	d (mm)	s (mm)	r _e (mm)	d _i (mm)	m (mm)	gatunki / grades												
								CVD		PVD		HW								
								NMP20	NMK20	NMK30	N250	N300	SM25T	H10S	H15X	H20S				
	03 WCMX 030208 04 WCMX 040208 05 WCMX 050308 06 WCMX 06T308	3,47 4,0 5,07 6,14	5,56 6,35 7,94 9,525	2,38 2,38 3,18 3,97	0,8 0,8 0,8 0,8	2,56 2,8 3,4 3,8	1,104 1,323 1,765 2,205													



Przykład zamówienia / Ordering example: WCMX 030208, NMK30 – 10 szt. / pcs

CVD, PVD (HC) - gatunek pokrywany / coated grade
(HW) - gatunek niepokrywany / uncoated grade

● - pierwszy wybór / first choice

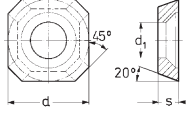
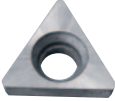
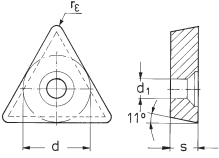
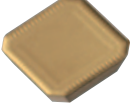
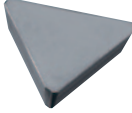
Płytki podporowe Shims		d (mm)	s (mm)	r _e (mm)	d ₁ (mm)	Długość boku płytki Insert edge length		
	220.13-621-12	10,30	3,18	-	4,20		12,7	
	220.13-624-15	12,20	3,18	-	4,20		15,875	
	175.11-624	10,85	3,18	0,60	4,20		22,0	
							SEKR SEAN SEKN	
							TPKN TPUN TPGN	



NARZĘDZIA DO FREZOWANIA

TOOLS FOR MILLING

str. / page: rozdział / chapter:

- F2 **Głowice frezowe ECO 45**
ECO 45 milling cutters
- F3 **Frezy trzpieniowe ECO 45**
ECO 45 shank cutters
- F4 **Frezy tarczowe NFTs..**
NFTs.. slitting cutters

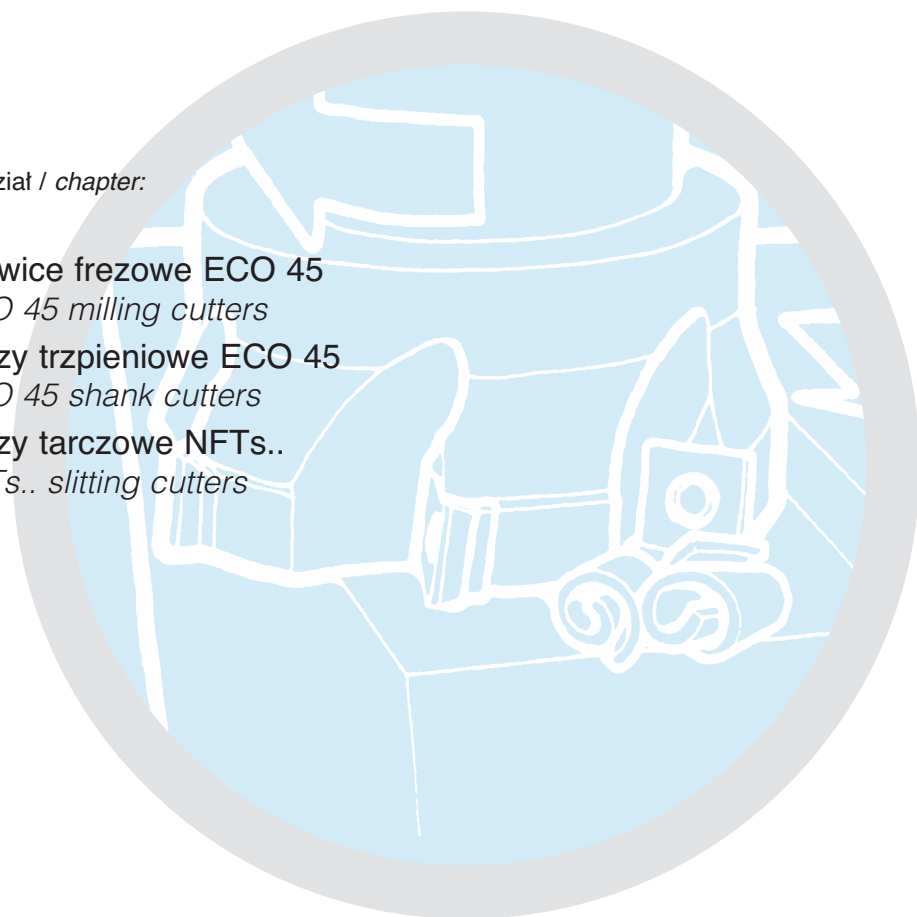

GQ..

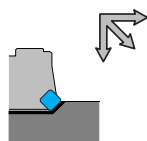

$$K_r = 45^\circ$$

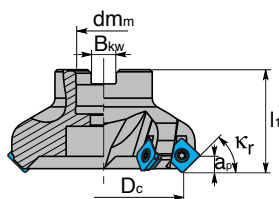

Ø 40 – Ø 125

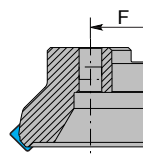

Ø 160

Oznaczenie Designation	Ilość ostrzy No. of teeth	D _c (mm)	a _p (mm)	B _{kw} (mm)	d _m (mm)	F (mm)	l ₁ (mm)	
GQ-12/040-03-AL-R	3	40	6	8,4	16	–	40	0,25
GQ-12/050-04-AL-R	4	50	6	10,4	22	–	40	0,30
GQ-12/063-05-AL-R	5	63	6	10,4	22	–	40	0,45
GQ-12/080-06-AL-R	6	80	6	12,4	27	–	50	0,80
GQ-12/100-07-AL-R	7	100	6	14,4	32	–	50	1,25
GQ-12/125-08-AL-R	8	125	6	16,4	40	–	63	2,65
GQ-12/160-10-AL-R	10	160	6	16,4	40	66,7	63	4,76
GQ-15/063-05-AS-R								
GQ-15/125-07-AL-R	7	125	8	16,4	40	–	63	2,25
GQ-15/160-08-AL-R	8	160	8	16,4	40	66,7	63	4,50



SDMT..AE/SDKT..AE

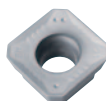

Części zamienne Spare parts

Średnica Ø (mm)
Diameter



Śruba
Screw



Klucz
Key



Smar
Grease



Zestaw
Kit



Śruba spec.
Spec. screw

D _c	40	12	DVF 2097	DMP 2099 (T20)	DDS 0463	DDR 2098	DVZ 1715
D _c	50	12	DVF 2097	DMP 2099 (T20)	DDS 0463	DDR 2098	28300
D _c	63 – 160	12	DVF 2097	DMP 2099 (T20)	DDS 0463	DDR 2098	–
D _c	50	15	DVF 2097	DMP 2099 (T20)	DDS 0463	DDR 2098	DVC 2103
D _c	63	15	DVF 2097	DMP 2099 (T20)	DDS 0463	DDR 2098	DVC 2102
D _c	80 – 160	15	DVF 2097	DMP 2099 (T20)	DDS 0463	DDR 2098	–

Frezy trzpieniowe ECO 45

ECO 45 shank cutters

GQ..CM..

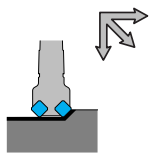

$$K_r = 45^\circ$$

CM

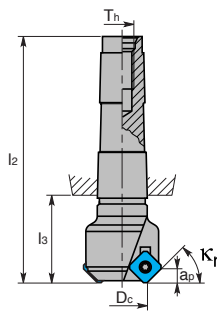

Oznaczenie Designation	Ilość ostrzy No. of teeth	D _c (mm)	a _p (mm)	T _h (mm)	l ₂ (mm)	l ₃ (mm)	Chwył Holder	kg
 GQ-12/032-03-CM3-5-R	3	32	6	M12	126	4	CM3	0,40

CM – Chwył Morse'a / Morse taper

SDMT..AE/SDKT..AE

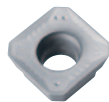

Części zamienne Spare parts

Średnica Ø (mm)
Diameter



Śruba
Screw



Klucz
Key



Smar
Grease



Zestaw
Kit

D _c	32 – 40	12	DVF 2097	DMP 2099 (T20)	DDS 0463	DDR 2098
----------------	---------	----	----------	----------------	----------	----------

Przykład zamówienia / Ordering example: GQ-12/032-03-CM3-5-R – 1 szt. / pcs

NFTs..

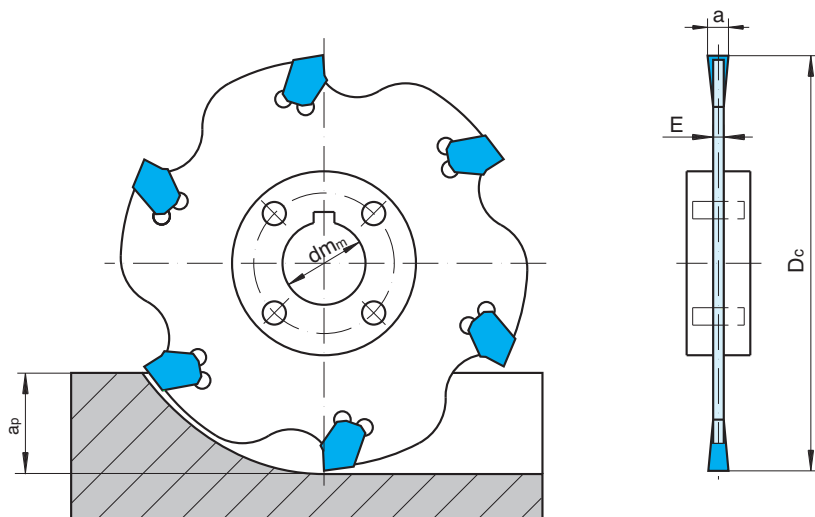

Frez tarczowy
Slitting cutter

	D_c (mm)	$d_{m\text{mm}}$ (mm)	E (mm)	Ilość ostrzy No. of teeth	n_{max} obr/min	a_p (mm)	Płytki Insert	a (mm)	Zabierak Adaptor ring
NFTs 100-22-3	100	22	2,4	6	800	27	LFMX 3N	3,1	Z 22-46
NFTs 100-22-4	100	22	3,2	6	800	27	LFMX 4N	4,1	Z 22-46
NFTs 100-22-5	100	22	4	6	800	27	LFMX 5N	5,1	Z 22-46
NFTs 125-32-3	125	32	2,4	8	640	35	LFMX 3N	3,1	Z 32-55
NFTs 125-32-4	125	32	3,2	8	640	35	LFMX 4N	4,1	Z 32-55
NFTs 125-32-5	125	32	4	8	640	35	LFMX 5N	5,1	Z 32-55
NFTs 160-32-3	160	32	2,4	10	500	52	LFMX 3N	3,1	Z 32-55
NFTs 160-32-4	160	32	3,2	10	500	52	LFMX 4N	4,1	Z 32-55
NFTs 160-32-5	160	32	4	10	500	52	LFMX 5N	5,1	Z 32-55
NFTs 160-40-3	160	40	2,4	10	500	39	LFMX 3N	3,1	Z 40-80
NFTs 160-40-4	160	40	3,2	10	500	39	LFMX 4N	4,1	Z 40-80
NFTs 160-40-5	160	40	4	10	500	39	LFMX 5N	5,1	Z 40-80
NFTs 200-40-3	200	40	2,4	14	400	59	LFMX 3N	3,1	Z 40-80
NFTs 200-40-4	200	40	3,2	14	400	59	LFMX 4N	4,1	Z 40-80
NFTs 200-40-5	200	40	4	14	400	59	LFMX 5N	5,1	Z 40-80
NFTs 250-40-3	250	40	2,4	18	320	84	LFMX 3N	3,1	Z 40-80
NFTs 250-40-4	250	40	3,2	18	320	84	LFMX 4N	4,1	Z 40-80
NFTs 250-40-5	250	40	4	18	320	84	LFMX 5N	5,1	Z 40-80
NFTs 315-40-4	315	40	3,2	22	250	117	LFMX 4N	4,1	Z 40-80
NFTs 315-40-5	315	40	4	22	250	117	LFMX 5N	5,1	Z 40-80

LFMX

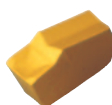

Części zamienne
Spare parts



Klucz płytki
Insert key

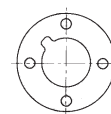

Zabierak
Adaptor ring

150.19-130

Z 22-46 / Z 32-55 / Z 40-80





INFORMACJE TECHNICZNE

TECHNICAL INFORMATION

str. / page: rozdział / chapter:

- G2 Zastosowanie narzędzi do toczenia
Application of tools for turning
- G16 Zastosowanie narzędzi do przecinania
Application of tools for parting
- G17 Zastosowanie narzędzi do rowkowania P61..
Application of tools for grooving P61..
- G18 Zastosowanie narzędzi do rowkowania z roztaczaniem P92..
Application of tools for grooving and recessing P92..
- G20 Zastosowanie narzędzi do frezowania
Application of tools for milling
- G26 Zastosowanie płytek do frezowania w narzędziach
innych producentów
Application of inserts for milling in other producers' tools
- G32 Zastosowanie narzędzi QUADRI i ECO 45
Application of QUADRI and ECO 45 tools
- G46 Zastosowanie narzędzi SR.. do frezowania form i matryc
Application of SR.. ball nose milling cutters
- G52 Zastosowanie frezów tarczowych NFTs..
Application of NFTs.. slitting cutters
- G54 Zestawienie materiałów obrabialnych
Materials comparison
- G56 Rodzaje zużycia ostrza
Tooth wear

1. Zasady doboru parametrów skrawania / Rules for selection of cutting data

Dobór parametrów skrawania dla określonej operacji uzależniony jest głównie od rodzaju obrabianego materiału, rodzaju obróbki, narzędzia, typowymiaru płytki oraz rodzaju i stanu obrabiarki.

Znajomość materiału obrabianego i jego własności, ma duże znaczenie w doborze optymalnych parametrów skrawania i gatunku węgliku spiekaneego. Przy występującej olbrzymiej ilości materiałów obrabianych podanie dokładnych parametrów skrawania dla każdego z nich jest niemożliwe. W związku z tym wszelkiego rodzaju zalecenia obejmujące parametry skrawania mogą mieć jedynie charakter wstępnych informacji, które wymagają każdorazowo dopasowania do konkretnej operacji.

Należy pamiętać, że w celu uzyskania najkorzystniejszego okresu trwałości ostrza, zachowując zadaną wydajność skrawania, dokonuje się doboru parametrów skrawania w kolejności odwrotnej do ich wpływu na intensywność zużycia ostrza.

Tak więc ustala się możliwie dużą głębokość skrawania (g), dobiera się możliwie duży posuw (p) i do tych parametrów dobiera się odpowiednią prędkość skrawania (v_c), (najczęściej odpowiadającą ekonomicznemu okresowi trwałości ostrza).

The selection of the cutting data for the specific operation mainly depends on the kind of workpiece, machining, tool, insert type and dimension and the machine tool kind and condition.

Good knowledge of the workpiece material and its properties is essential for selection of the optimum cutting data and the sintered carbide grade. Due to variety of workpiece materials it is impossible to give the exact cutting data for every material. Therefore all recommendations involving the cutting data serve as general information only, and they must be always adapted to the specific operation.

One should remember that the cutting data are selected reversely to their impact on the edge wear in order to optimise the tool life at the given cutting productivity.

Therefore the maximum depth of cut (g) is set, the maximum feed (p) is selected and the cutting speed (v_c) is selected accordingly (most often it corresponds to the economical tool life).



Chcąc dobrać optymalne parametry skrawania dla konkretnej operacji należy:

- dla danego materiału wybrać z tabel odpowiedni gatunek węgliku spiekaneego
- wybrać w zależności od operacji typowymiar płytki kierując się przy wyborze poniższymi zasadami:
 - określić maks. głębokość skrawania (a_p)
 - określić kąt przystawienia narzędzia (K_r)

To select the optimum cutting data to the specific operation you should:

- select the proper sintered carbide grade from the tables depending on the material to be machined
- select the insert type and dimension following the rules below:
 - determine the maximum depth of cut (a_p)
 - determine the entering angle of the tool (K_r)

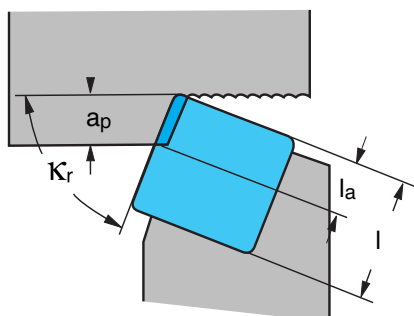

l_a = efektywna długość krawędzi skrawającej
effective cutting edge

l = długość krawędzi skrawającej
cutting edge length

Kąt przystawienia Entering angle K_r (°)	Głębokość skrawania / Cutting depth a_p (mm)										
	1	2	3	4	5	6	7	8	9	10	15
	Efektywna długość krawędzi skrawającej l_a (mm) Necessary effective cutting edge length										
90	1	2	3	4	5	6	7	8	9	10	15
105	1,5	2,1	3,1	4,1	5,2	6,2	7,3	8,3	9,3	11	16
120	1,2	2,3	3,5	4,7	5,8	7	8,2	9,3	11	12	18
135	1,4	2,9	4,3	5,7	7,1	8,5	10	12	13	15	22
150	2	4	6	8	10	12	14	16	18	20	30
165	4	8	12	16	20	24	27	31	35	39	58

– dobrać głębokość skrawania tak, aby usunąć nadatek w najmniejszej liczbie przejęć

– select the depth of cut to remove the excess material in the lowest possible number of cuts

☐ efektywną długość krawędzi skrawających dla poszczególnych rodzajów płytek przedstawiono poniżej

☐ effective cutting edge is shown below

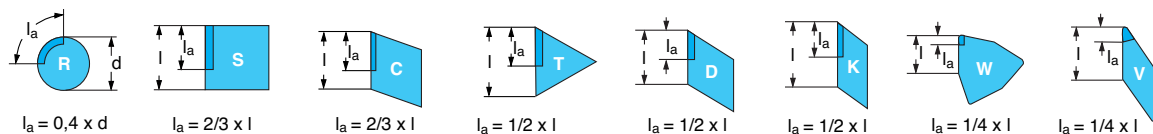

☐ celem zwiększenia odporności płytki wielostrzałowej należy stosować płytki z maks. możliwym kątem wierzchołkowym, pamiętając jednak, iż w miarę wzrastania tego kąta następuje wzrost wibracji

☐ to increase the indexable insert strength you should use inserts with the maximum nose angle, remembering, however, that vibrations increase along with this angle

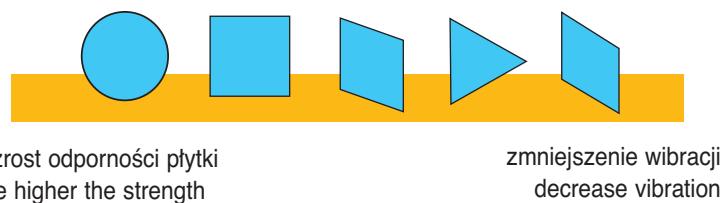

☐ dla obróbki zgrubnej wybrać największy z możliwych promień naroża celem zastosowania możliwie dużego posuwu

☐ in roughing you should select the largest nose radius in order to apply the highest feed

Promień naroża r_E (mm) Nose radius	0,4	0,8	1,2	1,6	2,4
Max. zalecany posuw Max recommended feed f_n (mm/obr.) (mm/rev)	0,2–0,27	0,4–0,5	0,5–0,8	0,7–1,0	1,0–1,6

Dla obróbki zgrubnej zaleca się stosowanie płytek z promieniem naroża 1,2–1,6
In roughing it is recommended to use the inserts with 1.2–1.6 nose radius

- jeżeli przedmiot obrabiany ma tendencję do wibracji, promień naroża należy zmienić na mniejszy
- standardowo posuw nie powinien przekraczać 1/2 promienia zaokrąglenia, jeżeli jednak decydujemy się na zastosowanie posuwu o wartości 2/3 promienia zaokrąglenia płytki, to powinny być spełnione następujące warunki:
- płytką musi być jednostronna
- kąt przystawienia mniejszy niż 90°
- materiał powinien wykazywać dobrą obrabialność
- w obróbce dokładnej dobrać możliwie największy posuw zapewniający dopuszczalną chropowatość powierzchni po obróbce
- if the workpiece tends to vibrate, the nose radius should be lower
- in general the feed should not exceed 1/2 rounded radius, but if you decide to use the feed of 2/3 rounded radius, the following conditions should be met:
- the insert must be single-sided
- the entering angle must be smaller than 90°
- the material should have good machinability
- in finishing, select the maximum feed to ensure the permissible surface roughness after machining

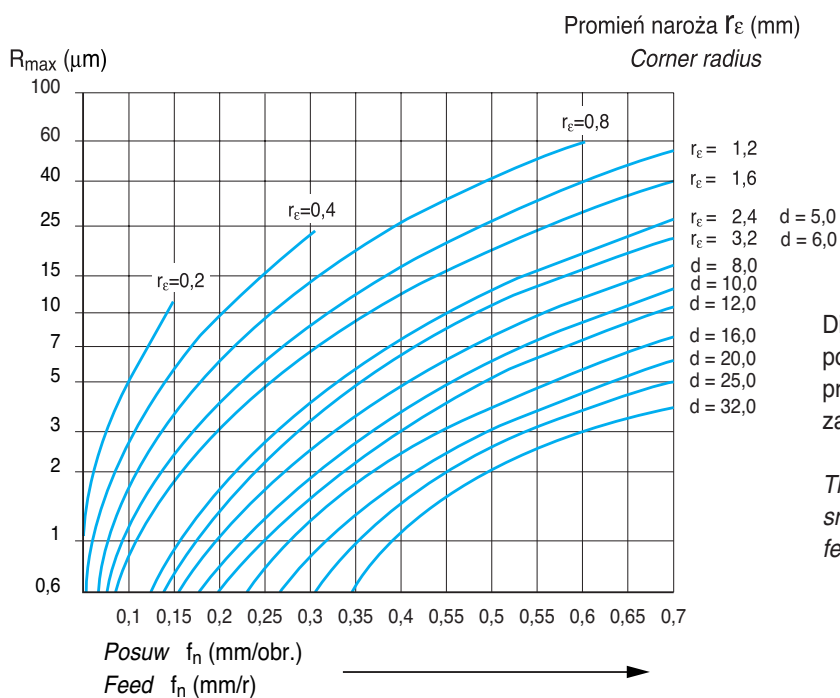

Diagram przedstawia teoretyczną gładkość powierzchni R_{max} możliwą do otrzymania przy odpowiednim dobraniu posuwu i promienia zaokrąglenia płytki

The graph shows the theoretical attainable surface smoothness R_{max} with appropriately selected feed and rounded radius.

- ustalić wstępnie prędkość skrawania w oparciu o zalecane parametry skrawania,
- sprawdzić wymaganą moc skrawania z mocą obrabiarki,
- przeprowadzić próbę skrawania, ewentualnie dokonać korekty p , g , v_c tak, aby nie była przekroczona moc obrabiarki oraz aby trwałość ostrza wynosiła ok. 15 minut
- to predetermine the cutting speed based on the recommended cutting data
- to check the required cutting power against the machine tool power
- to run a cutting test, possibly correct p , g , v_c so that the machine tool power is not exceeded and the tool life is roughly 15 minutes

$$P_c = \frac{V_c \times a_p \times f_n \times k_{c0,4}}{60 \times 10^3} \left[\frac{0,4}{f_n \times \sin K_r} \right]^{0,29} \quad [kW]$$

Wstępne informacje na temat doboru parametrów skrawania zestawiono w zalecanych parametrach skrawania (str. G6-G7).

Introductory information on selection of the cutting data is given in the recommended cutting data (page G6-G7).

Wskazówki praktyczne związane z doбором parametrów:

- ❑ płytki z ujemnym kątem natarcia w większości przypadków nadają się do obróbki zgrubnej
- ❑ zapotrzebowanie mocy dla płytek z ujemnym kątem natarcia jest o około 10–15% wyższe niż w przypadku płytek z kątem dodatnim
- ❑ przyjmuje się ogólną zasadę, aby maksymalna wielkość posuwu nie przekraczała 2/3 promienia zaokrąglenia naroża płytki
- ❑ głębokość skrawania dobiera się tak, aby w systemie **P** mocowania płytki nie przekroczyć 0,5 długości krawędzi skrawającej, w systemie **C** 0,7, a w systemie **S** 0,25 ÷ 0,5
- ❑ jakość powierzchni obrabianej zależy głównie od posuwu i promienia zaokrąglenia naroża (przy założeniu, że zamocowany przedmiot jest stabilny, braku drgań, a obrabiarka jest w należyłym stanie)
- ❑ w miarę wzrostu szerokości wyprasowanego łamacza wióra wzrasta zakres posuwów, przy których uzyskuje się łamanie wiórów
- ❑ wraz ze wzrostem głębokości i prędkości skrawania wzrasta zapotrzebowanie na moc obrabiarki

Parametry podane w tabelach wymagają każdorazowo sprawdzenia przez technologa w zakładzie oraz dopasowania do konkretnego stanowiska.

Practical hints connected with the selection of cutting data:

- ❑ inserts with negative tool rake angle are in most cases suitable for roughing
- ❑ power requirements for inserts with a negative tool rake angle are by about 10–15% higher than in case of inserts with a positive angle
- ❑ the general rule is that maximum feed should not exceed 2/3 nose radius,
- ❑ the depth of cut is selected so that in the **P** insert clamping system, 0.5 of the cutting edge length should not be exceeded, in the **C** clamping system 0.7 and in the **S** clamping system 0.25 ÷ 0.5
- ❑ the quality of the machined surface depends mainly on the feed and the rounded corner (assuming that the clamped workpiece is stable, there are no vibrations and the machine tool is in a proper condition).
- ❑ as the width of the pressed-out chipbreaker grows, the range feeds for chipbreaking increases
- ❑ as the depth of cut and the cutting speed increase, the power requirements of the machine tool raise.

The data given in the tables must be always checked by the works process engineer and adapted to the specific work stand.

Wzory pomocnicze:

Auxiliary formulas:

$$V_c = \frac{\pi \times D_m \times n}{10^3} \quad [\text{m/min}] \quad \text{Prędkość skrawania} \\ \text{Cutting speed}$$

$$n = \frac{V_c \times 10^3}{\pi \times D_m} \quad [\text{obr/min}] \quad \text{Prędkość obrotowa} \\ \text{Rotation speed}$$

$$Q = v_c \times a_p \times f_n \quad [\text{cm}^3/\text{min}] \quad \text{Ilość usuniętego materiału} \\ \text{Material removal}$$

$$T_c = \frac{l_m}{f_n \times n} \quad [\text{min}] \quad \text{Czas obróbki} \\ \text{Machining time}$$

$$R_{\max} = \frac{f_n^2}{r_\epsilon} \times 125 \quad [\mu\text{m}] \quad \text{Gładkość powierzchni} \\ \text{Surface roughness}$$

D_m	Średnica obrabiana (mm) Machined diameter
v_c	Prędkość skrawania (m/min) Cutting speed
n	Prędkość obrotowa (obr/min) Rotation speed (rev/min)
T_c	Czas obróbki (min) Machining time
Q	Ilość usuniętego materiału (cm ³ /min) Material removal
l_m	Długość powierzchni obrabianej (mm) Machined surface length
P_c	Zapotrzebowanie mocy (kW) Power requirements
$K_{c,0.4}$	Siła skrawania dla wióra 0,4 mm (N/mm ²) Cutting strength for chip
f_n	Posuw na obrót (mm/obr) Feed per revolution (mm/rev)
K_r	Kąt przystawienia (stopnie) Entering angle (degree)
R_{\max}	Max wysokość profilu nierówności (dla obliczeń gładkości pow.) (μm) Max. roughness height profile (to calculate surface roughness)
r_ϵ	Promień naroża płytki (mm) Insert corner radius
a_p	Głębokość skrawania (mm) Depth of cut

2. Zalecane parametry skrawania / Recommended cutting data

Material <i>Material</i>	★	Twardość <i>Hardnes</i>	NTP15	NTP25	NTP35	NTM25	NTM35	NTK05	NTK25		
			Posuw (mm/obr) / <i>Feed (mm/rev)</i>								
			0,1-0,8	0,15-0,8	0,2-1,0	0,2-0,6	0,2-0,6	0,1-0,4	0,5		
		HB	Prędkość skrawania (m/min) / <i>Cutting speed (m/min)</i>								
P Stal węglowa konstrukcyjna ogólnego przeznaczenia <i>Constructional carbon steel of general application</i> C 0,2% C 0,4% C 0,7%	2000	135	430-230	380-185	280-150						
	2100	180	385-200	370-175	245-90						
	2180	230	150-80		200-70						
P Stal niskostopowa <i>Low -alloy steel</i> – wyżarzona / <i>annealed</i> – ulepszona / <i>hardened</i>	2100	180	350-170	300-150	180-90						
	2775	300	220-110	185-100	135-90						
P Stal szybko tnąca <i>High-speed steel</i> – wyżarzona / <i>annealed</i>		250	220-110	200-125	100-55						
P Staliwo <i>Cast steel</i> – niestopowe / <i>non-alloy</i> – niskostopowe / <i>low-alloy</i> – wysokostopowe / <i>high-alloy</i>	1800	200	240-130	215-115	120-65						
	2100	200	210-110	180-110	110-55						
	2500	225	175-85	160-75	85-50						
M Stal nierdzewna <i>Stainless steel</i> – ferrytyczno-martenzytyczna <i>ferr.-mart.</i> – utwardzana wydzieleniowo <i>hardened</i> – austenityczna <i>austenitic</i>	2300	200			150-90	110-80					
	3500	330				60-40					
	2450	180			120-80	100-80					
K Żeliwo szare <i>Grey cast iron</i> Żeliwo szare o wyższej wytrzymałości <i>Grey cast iron of higher strength</i> Żeliwo sferoidalne ferrytyczne <i>Ferritic nodular cast iron</i>	1100	180						350-210	225-110		
	1300	220						275-170	180-90		
	1050	150						175-135	140-65		
N Miedź / <i>Copper</i> Mosiądz / <i>Brass</i> Brąz / <i>Bronze</i> Stopy aluminium <i>Aluminium alloys</i> – nie obrobione cieplnie <i>not heat treated</i> – obrobione cieplnie <i>heat treated</i>	600	60									
	700	100									
	1750	90									
	700	60									
S Stopy żaroodporne, stopy tytanu <i>Heat resisting steel, titanium alloys</i>	950	100									
		250									

P Stal / *Steel*
M Stal nierdzewna / *Stainless steel*
K Żeliwo / *Cast iron*
N Stopy nieżelazne, aluminium
Non-ferritic alloys, aluminium alloys
S Stopy żaroodporne, stopy tytanu
Heat resistant steel, titanium alloys
H Materiały hartowane
Hard materials
HC – gatunek pokrywany / *coated grade (PVD, CVD)*
HW – gatunek niepokrywany / *uncoated grade*

KX20	N325	N335	N435	S10S	S20S	SM25T	S30S	H10S	H20S	2003	N
Posuw (mm/obr) / Feed (mm/rev)											
0,04-0,2	0,15-0,8	0,2-0,6	0,1-0,5	0,1-0,6	0,15-1,2	0,1-0,4	0,2-2,0	0,3	0,8	0,04-0,2	0,1-0,4
Prędkość skrawania (m/min) / Cutting speed (m/min)											
	380-200 370-180 250-150	280-200 250-120 200-90	230-110 200-90 180-70	380-200 310-150 250-120	300-200 250-90 200-80	280-180 220-90 170-60	220-70 190-60 150-50				
	300-170 180-100	250-100 150-100	180-90 130-60	250-120 170-80	200-80 110-50	150-80 100-40	150-50 90-30				
		120-70		120-50	100-40	90-40	90-30				
		150-80 120-60 90-50		155-120 155-110 125-90	150-70 110-50 90-40	140-70 90-40 60-35	140-50 95-40 70-40				
	180-110 90-50 160-100	160-110 70-45 150-100	150-70 110-50 130-70								
								210-80	95-60		
								170-60	70-40		
								165-60			
250-800								450-230	260-140	250-800	250-800
250-800								240-220	220-150	250-800	250-800
150-400								340-220	220-150	150-400	150-400
300-3000								2000-1200 550-300	1200-750 330-200	300-3000	300-3000
30-60										30-60	20-50

* wartość współczynnika K_c 0,4 N/mm²
specific cutting force for chip thickness 0,4 mm

3. Zakresy łamania wióra łamaczy płytek wieloostrowych / Chipbreaking diagrams

Stal zwykła – obróbka wykańczająca

Steel – finishing

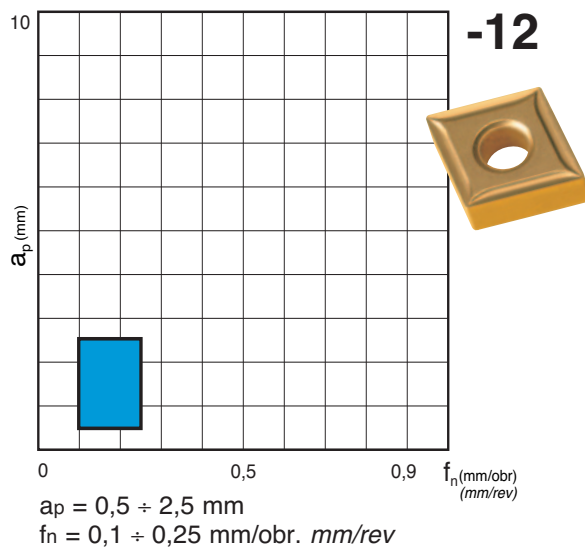
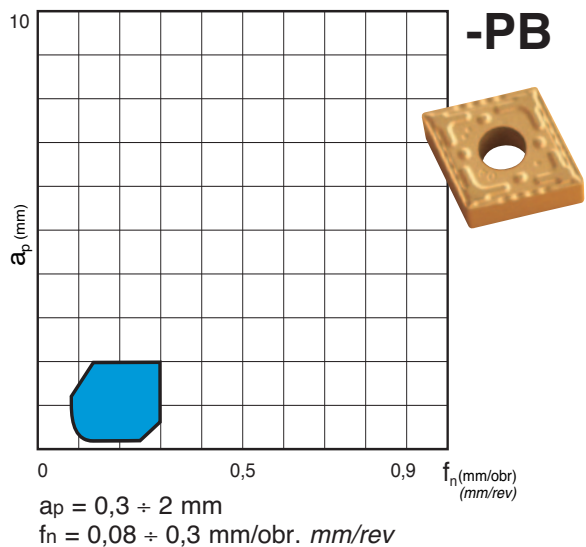

Stal zwykła – obróbka średniodokładna

Steel – semi-finishing

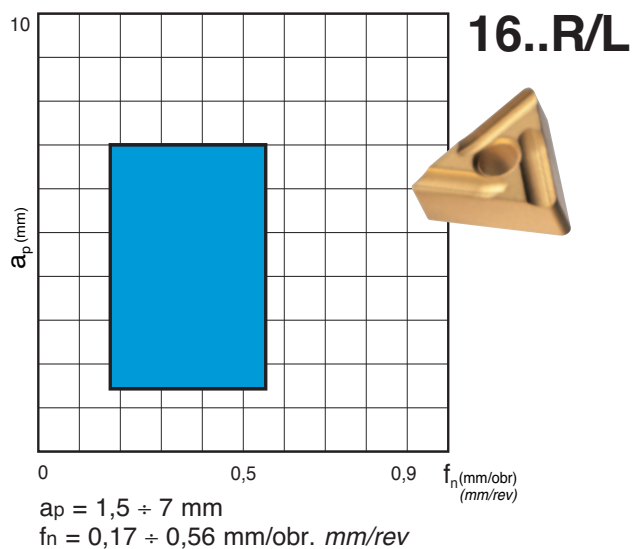
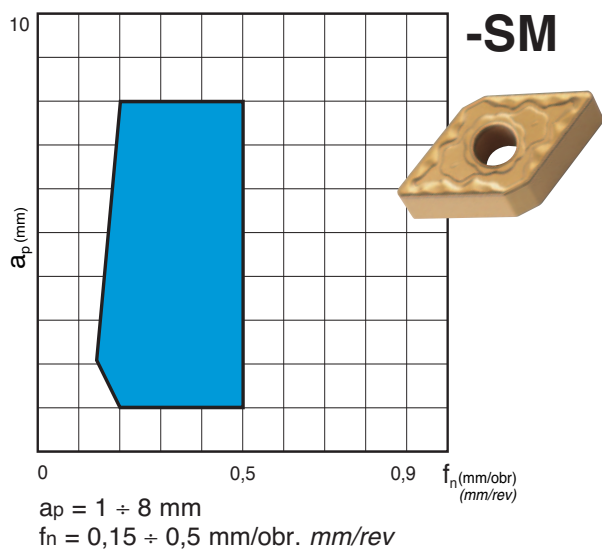
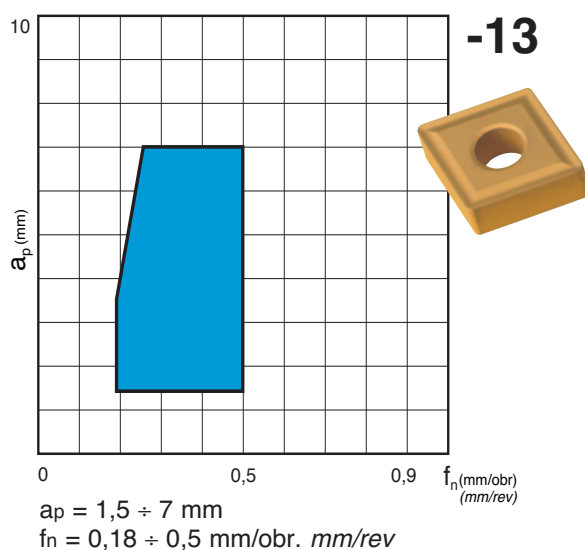
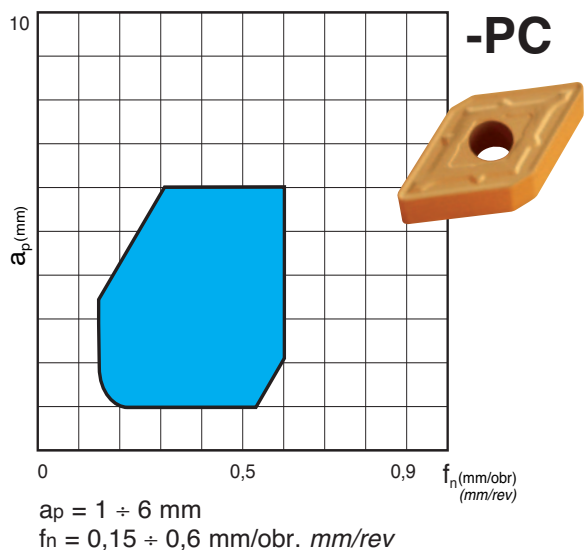

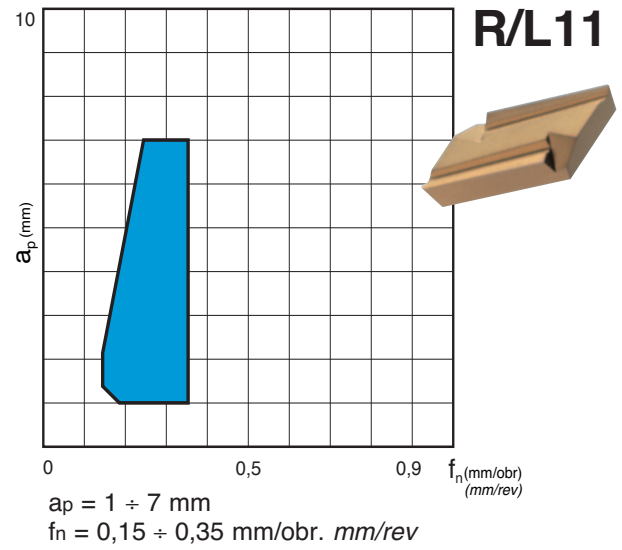
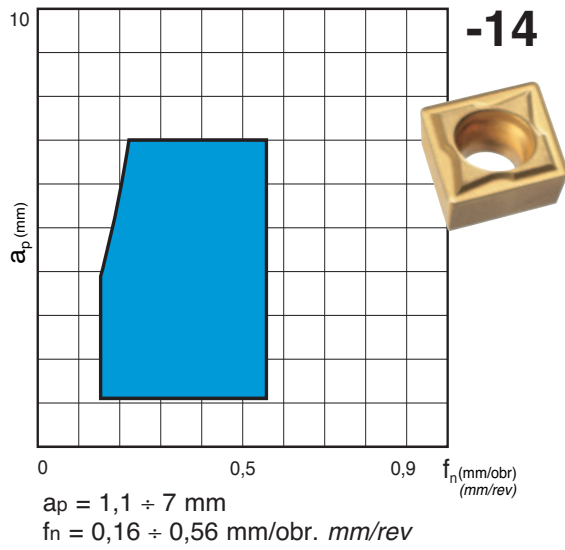
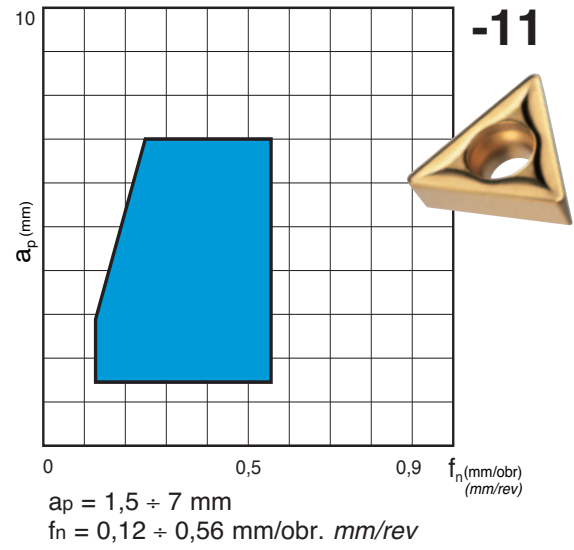
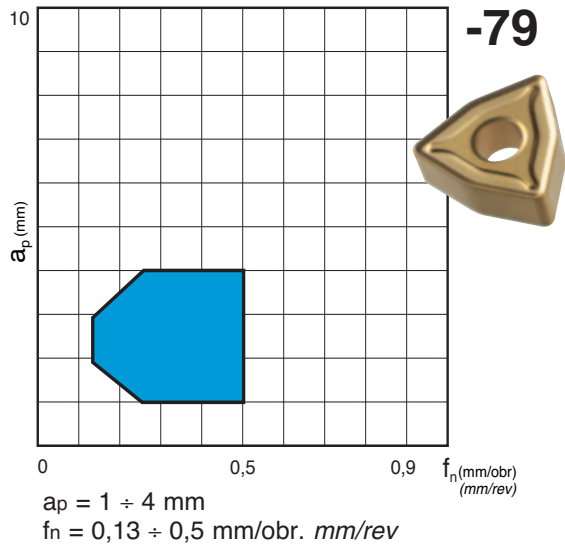

Stal zwykła – obróbka zgrubna i ciężka

Steel – roughing

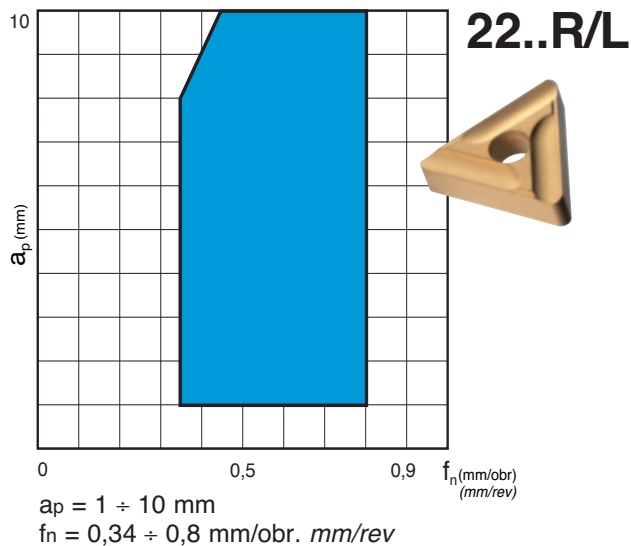
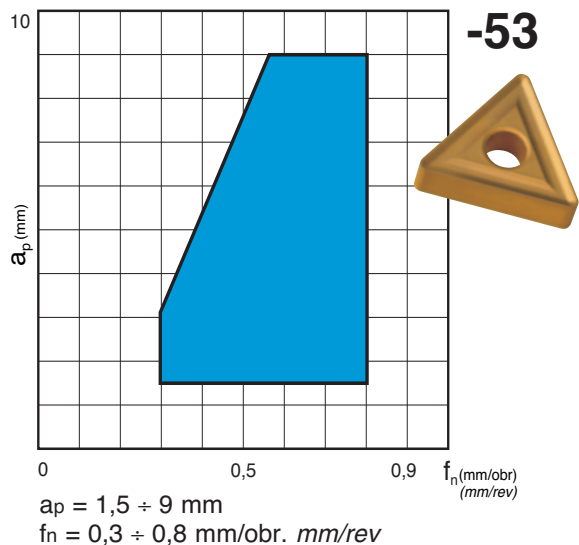
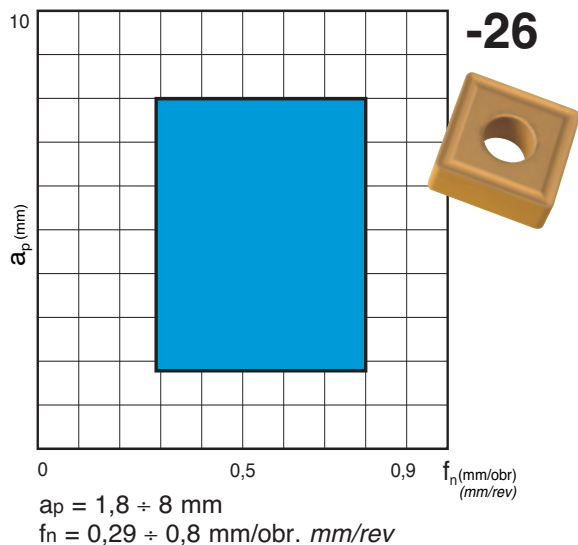
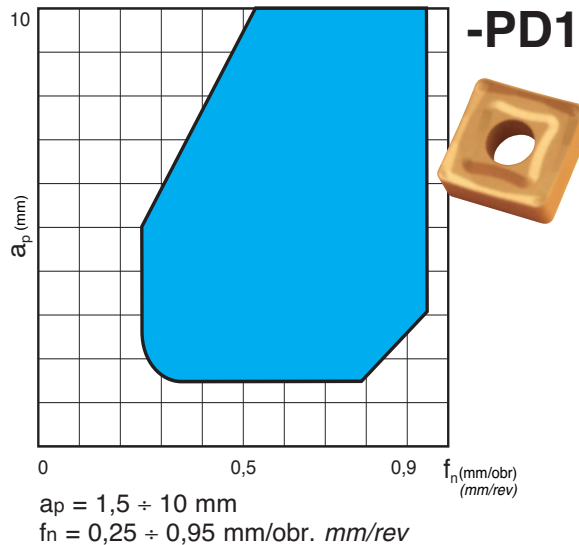
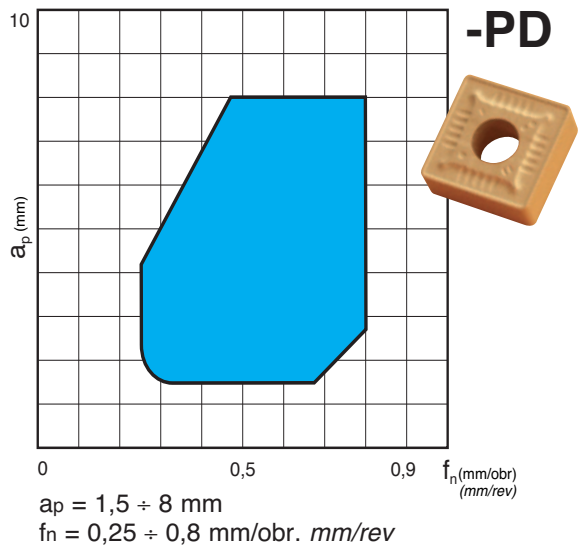

Stal nierdzewna – obróbka wykańczająca
Stainless steel – finishing

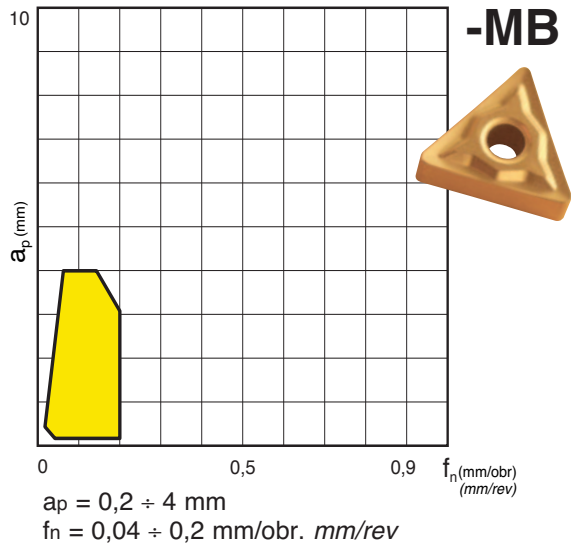

Stal nierdzewna – obróbka średniociadna
Stainless steel – semi-finishing

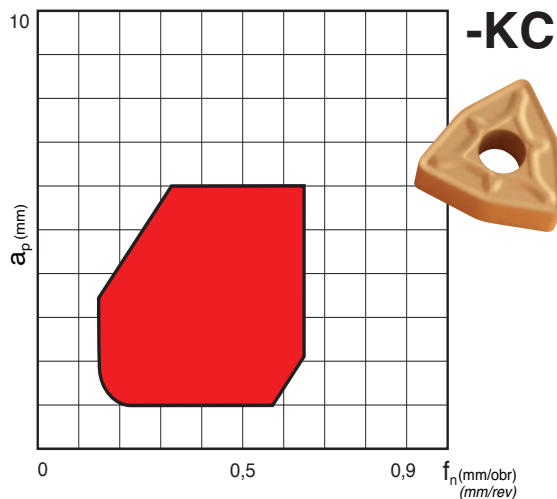
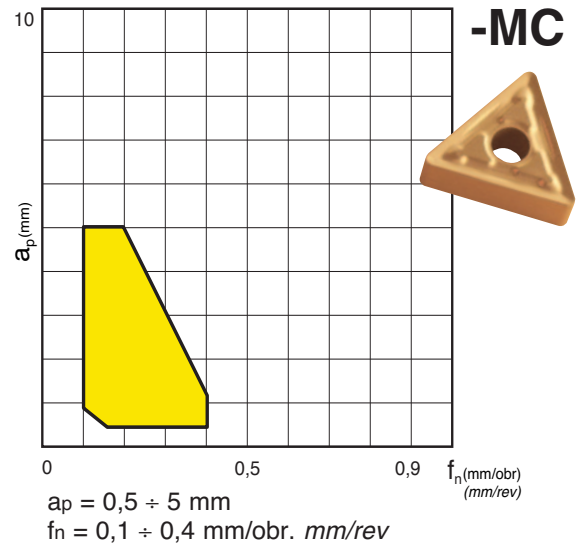

Żeliwo – obróbka średniociadna i zgrubna
Cast iron – semi-finishing and roughing

$a_p = 1 \div 6 \text{ mm}$
 $f_n = 0,15 \div 0,65 \text{ mm/obr. mm/rev}$

Aluminium – obróbka wykańczająca i średniociadna
Aluminium – finishing and semi-finishing

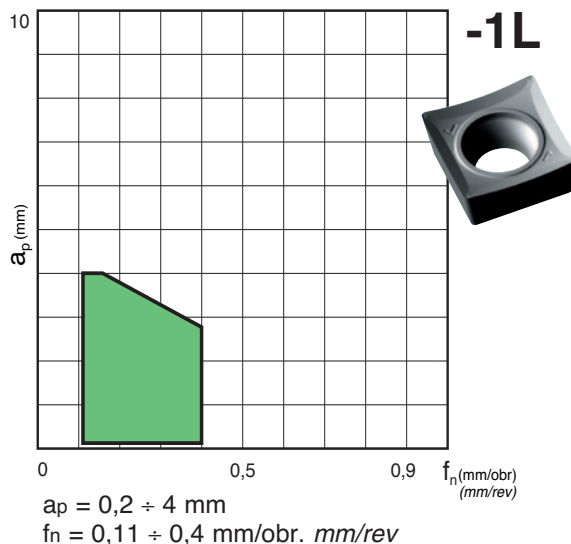

Stopy żaroodporne
Heat resistant steel

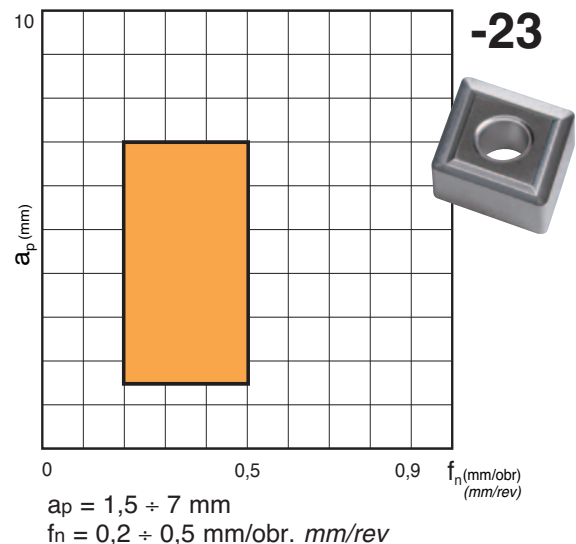

P

System mocowania

Clamping system

W systemie mocowania **P** stosowane są płytki z otworem cylindrycznym z płaską powierzchnią natarcia lub z prasowanym łamaczem wiórów. Noże w tym systemie wykorzystywane są głównie w operacjach toczenia zewnętrznego (obróbka zgrubna i wykańczająca) oraz do wytaczania dużych otworów.

System mocowania **P** występuje w dwóch odmianach:

- płytka mocowana za pomocą klina (zastosowanie głównie do obróbki wykańczającej przy operacjach toczenia zewnętrznego i wytaczania),
- płytka mocowana za pomocą dźwigni (najlepszy wybór do obróbki zgrubnej przy toczeniu zewnętrznym i wytaczaniu oraz do obróbki wykańczającej).

In P clamping system inserts with cylindrical holes with flat face or pressed in chipbreakers are used. Tools in this system are used mainly in external turning operations (roughing and finishing) and in boring of big holes.

P clamping system is available in two versions:

- an insert clamped with a wedge (mainly applied for finishing in external turning and boring),
- an insert clamped with a lever (the best choice for roughing in external turning and boring as well as for finishing).

G

P

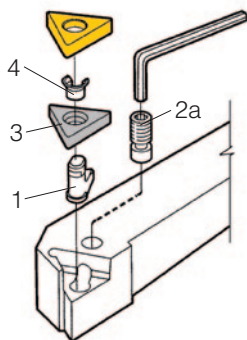

- 1 Dźwignia kątowa / Lever
- 2a Śruba / Screw
- 3 Płytki podporowa / Shim
- 4 Tuleja sprężysta / Shim pin

P

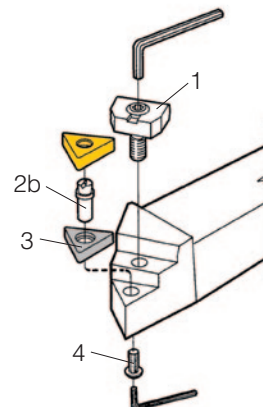

- 1 Klin / Clamp
- 2b Kotek / Pin
- 3 Płytki podporowa / Shim
- 4 Śruba / Screw

M

System mocowania

Clamping system

W systemie mocowania **M** stosowane są płytki z otworem cylindrycznym z płaską powierzchnią natarcia lub z prasowanym łamaczem wiórów. Noże w tym systemie wykorzystywane są głównie w operacjach toczenia zewnętrznego (obróbka zgrubna i wykańczająca) oraz do wytaczania dużych otworów.

System mocowania **M** występuje w dwóch odmianach:

- płytki mocowane za pomocą klina z górnym dociskiem (do obróbki zgrubnej i wykańczającej przy toczeniu zewnętrznym),
- płytki mocowane za pomocą górnego elementu dociskowego (przeznaczona dla płytki VNMG do obróbki kształtowej).

In M clamping system inserts with cylindrical holes with flat face or pressed in chipbreakers are used. Tools in this system are used mainly in external turning operations (roughing and finishing) and in boring of big holes.

M clamping system is available in two versions:

- an insert clamped with a wedge and clamp (mainly applied for roughing and finishing in external turning)
- an insert clamped with a top clamp (designed for VNMG inserts for profiling).

M

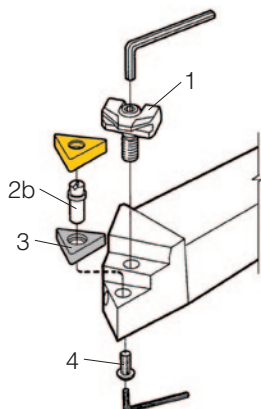

- 1 Klin z górnym dociskiem / Clamp
- 2b Kołek / Pin
- 3 Płytki podporowa / Shim
- 4 Śruba / Screw

M

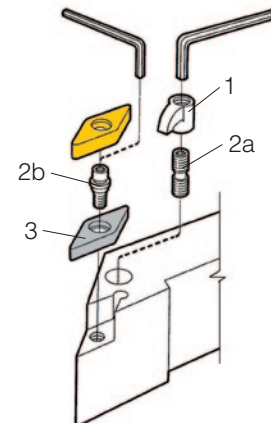

- 1 Górny element dociskowy / Clamp
- 2a Śruba / Screw
- 2b Kołek / Pin
- 3 Płytki podporowa / Shim

RC

System mocowania

Clamping system

System mocowania **RC** (Rigid Clamping) przeznaczony jest dla płytek z otworem cylindrycznym wykonanych z węgla spiekane, ceramiki i CBN. Zapewnia stabilne i bezpieczne mocowanie płytki w gnieździe narzędzia oraz gwarantuje doskonałą powtarzalność położenia wierzchołka płytki, a tym samym utrzymanie wąskich tolerancji wykonania detalu. Zalecany szczególnie w przypadku obróbki materiałów i operacji którym towarzyszą duże i zmienne siły skrawania.

The RC (Rigid Clamping) system allows for clamping of inserts with cylindrical holes, made of cemented carbide, ceramics and CBN. The RC System offers very stable and safe clamping of inserts in their seats, which guarantees high repeatability of the insert edge position and thereby helps us keep a very narrow tolerance of processed details.

Tools in this system are especially recommended for use in operations with very strong and variable cutting forces.

G

RC



- 1 Płytki / Insert
- 2 Śruba podkładki / Shim screw
- 3 Płytki podporowa / Shim
- 4 Zestaw mocujący / Clamp set

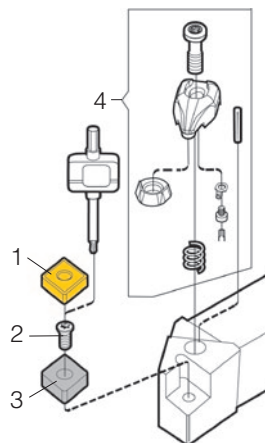

S

System mocowania

Clamping system

System mocowania **S** przeznaczony jest dla płytek z otworem stożkowo-łukowym. Bardzo duża dokładność mocowania płytki w gnieździe oprawki pozwala na stosowanie noży do obróbki wykańczającej zarówno przy toczeniu, jak i przy wytaczaniu otworów.

System ten stosowany jest głównie dla płytek i noży małogabarytowych, dlatego zalecany jest do maszyn z niedużą przestrzenią roboczą (np. maszyny CNC, automaty tokarskie itp.).

This system allows for clamping of inserts with partly cylindrical fixing holes with a positive clearance angle. Due to great repeatability of insert clamping toolholders of this system are used for finishing in turning and boring.

The system is used mainly for small-sized inserts and toolholders, therefore it is recommended for machines with limited working area (e.g. CNC machines, automatic turning machines etc.)

C

System mocowania

Clamping system

System mocowania **C** przeznaczony jest dla płytek bezotworowych. Noże tokarskie w tym systemie posiadają dwa rodzaje geometrii gniazda płytki:

– dodatnią dla płytek z pozytywnym kątem przyłożenia $\alpha_n = 11^\circ$ (SPUN, TPUN itd.),

– ujemną dla płytek z kątem przyłożenia $\alpha_n = 0^\circ$.

Narzędzia z geometrią dodatnią przeznaczone są do obróbki wykańczającej oraz do toczenia detali o małym przekroju z tendencją do tworzenia drgań. Noże z ujemną geometrią znajdują zastosowanie do obróbki zgrubnej.

Odmianą systemu **C** jest oprawka nożowa dla płytki KNUX przeznaczona głównie do obróbki kształtowej. Może być również stosowana do operacji wytaczania.

C clamping system is designed for inserts without holes. Turning tools in this system have two types of insert seat geometry.

– positive geometry for inserts with a positive clearance angle $\alpha_n = 11^\circ$ (SPUN, TPUN etc.),
– negative geometry for inserts with a clearance angle $\alpha_n = 0^\circ$.

Tools with positive geometry are designed for finishing and turning of elements with a small intersection that tend to vibrate.

Tools with negative geometry are used for roughing. A C system variation is a toolholder for KNUX inserts, designed mainly for profiling. It can also be used for boring.

S

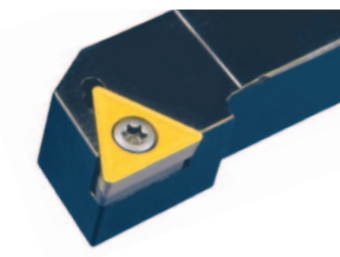

- 1 Śruba płytki / Insert screw
- 2 Śruba podkładki / Shim screw
- 3 Płytką podporowa / Shim

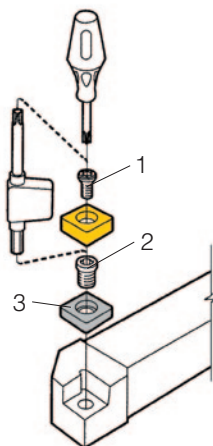

C

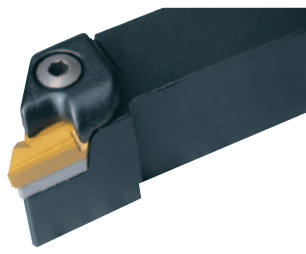

- 1 Docisk / Clamp
- 2a Śruba / Screw
- 2b Kołek ze sprężyną / Spring and pin
- 3 Płytką podporowa / Shim
- 4 Tuleja sprężysta / Shim pin
- 5 Sprężyna / Spring

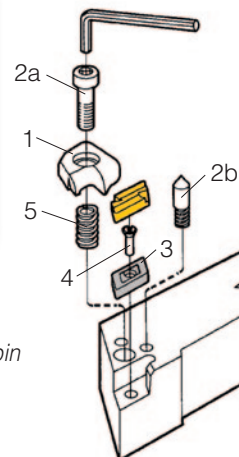

Application of tools for parting

Przecinaki listwowe stosowane są do przecinania materiałów o zróżnicowanej twardości: stali, staliwa, żeliwa. W skład narzędzia wchodzi:

- listwa,
- imak blokowy,
- płytki z węglika spiekane.

Nowoczesna konstrukcja listwy oraz zastosowanie specjalnego stopera, zapobiega nadmiernemu wsuwaniu się płytki do gniazda listwy, co znacznie podnosi jej efektywność i wydajność pracy, chroniąc zarazem przed zbyt szybkim zużyciem.

Parting tools are used for parting of materials with varied hardness: steel, cast steel, cast iron. The tool consists of:

- a blade,
- a clamping block,
- a sintered carbide insert.

Modern blade construction and application of a special stopper prevents excessive slipping of the insert into the blade seat, which increases its efficiency and productivity, protecting it at the same time against too quick wear.



Uwagi praktyczne:

- płytkę należy zamontować w gnieździe przy użyciu plastikowego młotka,
- jako minimalny należy przyjąć posuw, przy którym uzyskuje się wiór spiralny,
- zalecaną głębokość wcinania określa się wzorem:

$$a_p = 7 \times a$$

gdzie: a_p - głębokość wcięcia
 a - szerokość płytki

- przy przecinaniu pełnych prętów krawędź ostrza płytki skrawającej powinna znajdować się 0,10 ÷ 0,15 mm ponad osią obrabianego materiału,

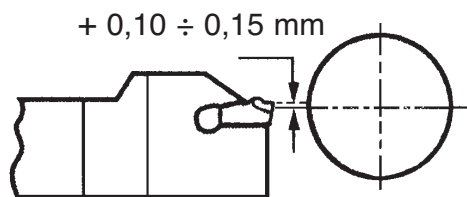

- zalecane jest zredukowanie posuwu do ok. 0,05 mm/obr. przy zbliżaniu się do osi przecinanego detalu gdy $a \geq d$.

Practical suggestions:

- an insert must be clamped in the seat by means of a plastic hammer,
- the minimum feed is the feed where a spiral chip is produced,
- the recommended cutting depth is determined by the formula:

$$a_p = 7 \times a$$

where: a_p - cutting depth
 a - insert width

- when cutting solid bars, the cutting edge of the insert should be 0.10 - 0.15 mm above the workpiece axis,

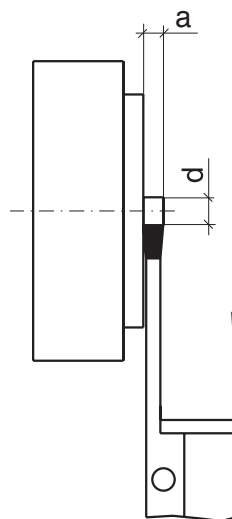

- it is recommended that the feed should be reduced up to approx. 0.05 mm/rev when approaching the workpiece axis if $a \geq d$.

Application of tools for grooving P61..

Płytki wielostrzowe do nacinania rowków produkowane są jako dwustrzowe, w poniższych odmianach:

- płytki do rowków o profilu prostokątnym, oznaczone symbolem **X61.... R/L** wytwarzane w wersji prawo- i lewotnącej, w znormalizowanym, zgodnym z PN szeregu o szerokości rowka od 1,1 – 3,15 i 4,15 – 5,50 mm,
- płytki do rowków o profilu okrągłym, oznaczone symbolem **X61....-R R/L** również wytwarzane w wersji prawo- i lewotnącej o znormalizowanym, zgodnym z PN, szeregiem promieni uszczelnień okrągłych $r_e = 1,0; 1,5; 2,0; 2,5$ mm.

Dla zagwarantowania wysokiej trwałości i powtarzalności wymiaru szerokości nacinanego rowka, płytki wykonane zostały ze specjalnego gatunku węgla spiekane pokrytego w procesie PVD związkami tytanu.

Noże składane do nacinania rowków produkuje się do:

- toczenia rowków zewnętrznych oznaczone symbolem **P61.SFR/L** oferowane w wersji prawo- i lewotnącej,
- toczenia rowków wewnętrznych od średnicy $D_m = 16$ mm oznaczone symbolem **P61.SGR/L** oferowane w wersji prawo- i lewotnącej.

Dostępne są także praktyczne zestawy narzędzi do nacinania rowków **ZESTAW – 61**, zawierające komplet noży składanych i płytek o profilu prostokątnym w pełnym zakresie znormalizowanych rowków.

Indexable inserts for grooving are produced as two-edge inserts in the following options:

- inserts for rectangular grooving, designated as **X61... R/L** made in right- and left-cutting versions in a standard PN-compliant series with a groove width of 1.1 – 3.15 and 4.15 – 5.50 mm,
- inserts for round grooving, designated as **X61...-R R/L** also made in right- and left-cutting versions with a standard PN-compliant series of round radii $r_e = 1.0; 1.5; 2.0; 2.5$ mm.

To ensure long tool life and high groove width repeatability, inserts are made of special sintered carbide grade, coated with titanium compounds in a PVD process.

Toolholders for grooving are designed for:

- external grooving, designated as **P61.SFR/L** available in right- and left-cutting versions,
- for internal grooving with a diameter of $D_m=16$ mm, designated as **P.61.SGR/L** available in right- and left-cutting versions.

Practical grooving sets **SET – 61** – are available. They consist of a set of toolholders and indexable inserts with a rectangular profile in a full range of standard grooves

ZESTAW – 61 / SET – 61



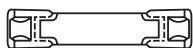

X92..-N

Pierwszy wybór do rowkowania i przecinania.

First choice for grooving and parting.

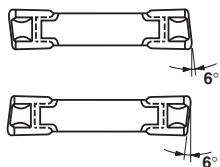

X92..-R, X92..-L

Alternatywny wybór do przecinania - kąt czołowy 6° pozwala na zmniejszenie czopika pod koniec przecinania i likwiduje zadziory ale powoduje tendencje do odginania się narzędzia co może mieć negatywny wpływ na trwałość płytki i jakość powierzchni obrabianej.

Alternative choice for parting – 6° face angle reduce the nib at the end of parting and removes burrs but as a consequence the tool tends to bend out, which may have a negative impact on insert life and surface quality.

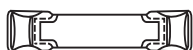

X92..-S

Pierwszy wybór do rowkowania z roztaczaniem.

First choice for grooving and recessing.

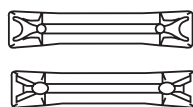

X92..-MS, X92..-VS

Alternatywny wybór do rowkowania z roztaczaniem szczególnie do roztaczania z większymi głębokościami.

Alternative choice for grooving and recessing, in particular for recessing at higher depths.

Zalecane prędkości skrawania v_c / Recommended cutting speed v_c (mm/min)

Rodzaj płytki Insert type	X92..-N, -R, -L	X92..-S	X92..-MS	X92..-VS	Zalecane posuwy f_n (mm/obr) Recommended feed (mm/rev)
Rowkowanie i przecinanie Grooving and parting	120	90	100	100	0,1
Rowkowanie z roztaczaniem Grooving and recessing	—	150	90	120	max. 0,16
Rowkowanie od czoła Face grooving	150	120	—	—	max. 0,14

Zalecenia ogólne: / General recommendations:

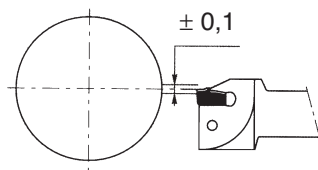

① Ustawienie noża w osi z dokładnością $\pm 0,1$ ma istotny wpływ na trwałość płytki i jakość obróbki.
Positioning of the holder in an axis with ± 0.1 accuracy considerably affects insert life and performance.

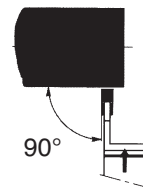

② Prostopadłe ustawienie noża do osi przedmiotu obrabianego gwarantuje prostopadłość powierzchni po cięciu, zmniejszenie drgań, zwiększenie trwałości ostrza.
Perpendicular positioning of the holder towards the workpiece guarantees perpendicular surface after cutting, decreases vibrations and increases edge life.

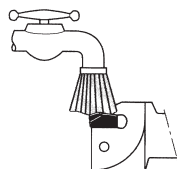

③ Zaleca się stosowanie chłodziwa w trakcie obróbki (prawidłowe chłodzenie zwiększa trwałość ostrza).
Use of coolant during machining is recommended (correct cooling increases edge life).

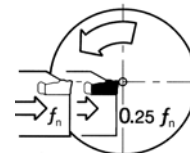

④ Redukcja posuwu przy przecinaniu na 3-4 mm przed osiągnięciem osi detalu pozwala zmniejszyć obciążenie ostrza skrawającego.
Reduction of feed when cutting in 3-4 mm before reaching the workpiece axis leads to lower load on the cutting edge.

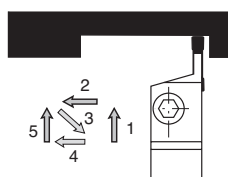

⑤ Przy roztaczaniu przed zmianą kierunku posuwu zaleca się odsuwać nóż od detalu i po wzdłużnym dosunięciu do ścianki ponownie zagłębić w materiał. Pozwala to na zmniejszenie błędów spowodowanych ugięciem narzędzia a w rezultacie na poprawę jakości obróbki i zwiększenie trwałości noża.
When recessing, before changing the feed direction, it is recommended that the edge should be moved away from the workpiece and after moving it longitudinally towards the wall, dipped into the material again. This will lead to fewer errors due to bending of the tool and, consequently, improve performance and tool life.

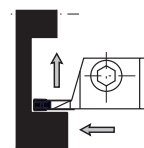

⑥ Stosując płytki X92...-S można roztaczać rowki od czoła w zakresie średnic określonych rodzajem wkładki C92. Zaleca się aby obróbkę zaczynać od maksymalnej dopuszczalnej średnicy i prowadzić ją do osi.
Using X92...-S inserts face grooves may be recessed within the diameter range determined by a type of C92 insert. It is recommended that machining should start with a maximum permissible diameter and then led towards the axis.

1. Zasady doboru parametrów skrawania / Rules for selection of cutting data

Frezowanie współbieżne i przeciwbieżne

Frezowanie przeciwbieżne (rys. 1) charakteryzuje się tym, że przedmiot obrabiany wykonuje ruch posuwowy w kierunku przeciwnym do kierunku obrotów freza. Grubość warstwy skrawanej rośnie od wartości 0 przy wejściu ostrza w materiał do wartości równej zadanemu posuwowi f_z . Jest to zjawisko niekorzystne z kilku powodów:

- na początku płytka zamiast skrawać, nagnięta materiał utwardzając go,
- tworzy się wysoka temperatura spowodowana tarciem płytki o materiał obrabiany,
- narzędzie ma tendencje do „odrywania” materiału obrabianego od stołu obrabiarki, co wiąże się z koniecznością stosowania bardzo pewnego mocowania.

Wyżej wymienione wady powodują szybsze zużywanie się płytki wieloostrowej, a tym samym obniżają efektywność obróbki. Ten rodzaj frezowania **zalecany jest do obróbki dokładnej oraz powinien być stosowany na obrabiarkach pozbawionych możliwości dokładnej kasacji luzów wzdłużnych stołu frezarki.**

Frezowanie współbieżne (rys. 2) charakteryzuje się tym, że przedmiot obrabiany wykonuje ruch posuwowy w kierunku zgodnym z ruchem obrotowym freza. Grubość warstwy skrawanej maleje od zadanej wartości f_z do 0 w związku z czym nie występują problemy opisane w metodzie przeciwbieżnej. Dlatego frezowanie współbieżne **zalecane jest do większości operacji frezerskich, przy czym może być stosowane tylko na obrabiarkach, na których istnieje możliwość prawidłowej kasacji luzów wzdłużnych stołu.**

Down and up milling

In up milling (fig.1) the workpiece feed-moves in the opposite direction to the mill rotations. The cut layer gets thicker from 0 value at the start of cut to the value equal to the given f_z feed. This is a negative phenomenon due to several reasons:

- at the beginning an insert burnishes the material and hardens it instead of cutting
- high temperature is created by the friction between the insert and the workpiece
- the tool tends to “break” the workpiece off the machine tool table which necessitates very firm clamping.

The above-mentioned faults increase the wear of the indexable insert and consequently decrease the cutting efficiency. This kind of milling **is recommended for finishing and should be used in the machine tools, which cannot reduce accurately the longitudinal backlashes of the milling machine table.**

In down milling (fig. 2) the workpiece feed-moves in the same direction as the mill rotations. The cut layer gets thinner from the given f_z value to 0 and therefore the problems described in the up milling method do not occur here. That is why down milling **is recommended for most of the milling operations but it may be used only in such machine tools where the longitudinal backlashes of the table can be reduced correctly.**

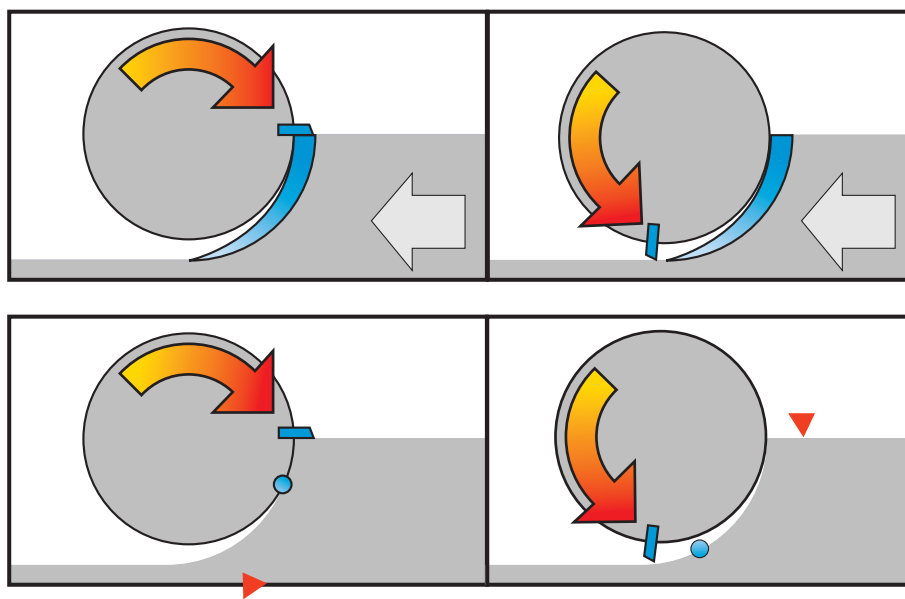

Rys. 2
Fig. 2

Rys. 1
Fig. 1

Dobór głowicy frezowej

Na prawidłowy przebieg procesu frezowania ma wpływ m.in. odpowiedni dobór głowicy frezowej. Poniżej podajemy kilka informacji, które powinny Państwu ułatwić podjęcie decyzji:

Wyróżniamy dwa podstawowe typy głowic:

- głowice drobnoostrzowe –
stosowane są do obróbki żeliwa i średniodokładnej obróbki stali,
- głowice zwykłe –
stosowane są do obróbki zgrubnej i dokładnej stali oraz w przypadkach, gdy tendencje do powstawania drgań zagrażają pozytywnemu wynikowi obróbki.

Głowice charakteryzują się następującymi rodzajami geometrii:

- głowica podwójnie negatywna (kąty natarcia γ_f promieniowy i γ_p osiowy są ujemne - patrz rys. 3) – przeznaczona jest dla płytek z zerowym kątem przyłożenia. **Zaleca się stosowanie do obróbki twardych materiałów.**
- głowica podwójnie pozytywna (kąty γ_f i γ_p dodatnie - patrz rys. 4) - **zalecana jest do obróbki detali kruchych, niestabilnych i mających tendencje do utwardzania się w czasie obróbki. Ponadto przydatna jest do obrabiarek małej mocy.**
- głowica pozytywno-negatywna (kąty γ_p dodatni, γ_f ujemny - patrz rys. 5) - **zalecana jest do frezowania z dużymi głębokościami skrawania oraz do frezowania wgłębnego.**

Selection of a milling cutter:

The milling process is influenced, among others, by the right selection of the milling cutter. Below you will find the information which makes it easier to select:

There are two basic types of the milling cutters:

- close pitch milling cutters –
used for machining of cast iron and medium machining of steel,
- coarse pitch milling cutters –
used for roughing and finishing of steel and in cases when the vibration tendencies can influence the machining results.

There are the following kinds of milling cutter geometries:

- double negative milling cutter (γ_f axial rake angles and γ_p radial rake angles are negative - see fig.3) – designed for inserts with zero clearance angle. **It is recommended for machining of hard materials.**
- double positive milling cutter (γ_f and γ_p angles are positive - see fig.4) - **it is recommended for machining of fragile, unstable components and the materials which tend to get harder when machined. Moreover it is useful for low power machine tools.**
- positive-negative milling cutter (γ_f is negative, γ_p is positive - see fig.5) - **recommended for milling with high cutting depths and for in-cut milling.**

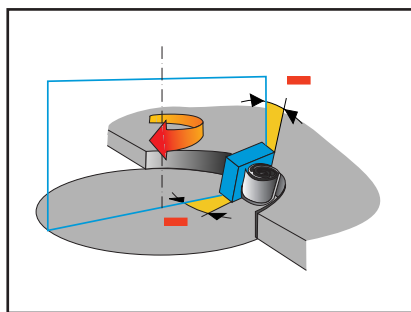

Rys. 3
Fig. 3

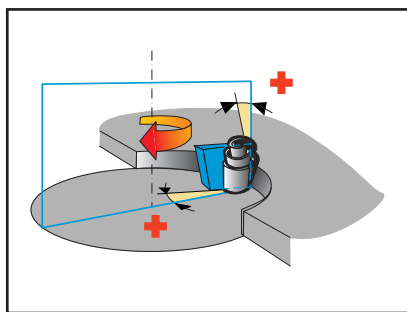

Rys. 4
Fig. 4

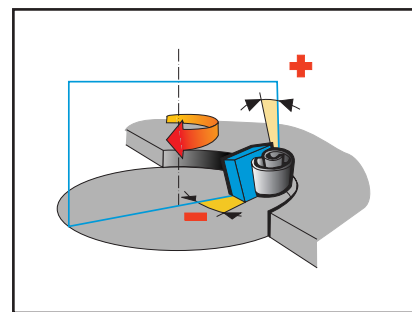

Rys. 5
Fig. 5

Oprócz kątów natarcia istotnym kątem w geometrii głowicy jest również kąt przystawienia K_r :

- głowice z kątem $K_r = 90^\circ$ stosowane powinny być głównie do frezowania walcowo-czołowego. Ponadto zaleca się stosowanie ich do obróbki długich i cienkich detali,
- głowice z kątem $K_r = 75^\circ$ zaleca się stosować do frezowania zgrubnego i dokładnego,
- głowice z kątem $K_r = 45^\circ$ znajdują zastosowanie głównie przy obróbce detali mających tendencje do drgań, na maszynach o małej mocy oraz gdy występuje konieczność pracy na przedłużonym trzpieniu,
- głowice z płytkami okrągłymi (K_r zmienne w zależności od głębokości skrawania) znajdują zastosowanie do obróbki zgrubnej twardych materiałów.

Besides radial rake angles, the K_r entering angle is also important in milling cutter geometry:

- milling cutters with $K_r = 90^\circ$ should be used mainly for end milling. Moreover they are recommended for machining of long and thin components.
- milling cutters with $K_r = 75^\circ$ are recommended for roughing and finishing
- milling cutters with $K_r = 45^\circ$ are used mainly for machining of unstable components in low power machines and in long tool overhang working.
- milling cutters with all-round inserts (K_r varies depending on cutting depth) are used for roughing of hard materials.

Dobierając średnicę głowicy należy pamiętać o zasadzie, że powinna być ona 1,2-1,5 razy większa od szerokości materiału obrabianego.

Przy obróbce szerokich powierzchni najlepsze wyniki osiąga się ustawiając głowicę tak, aby szerokość skrawania była równa 75% średnicy narzędzia.

Selecting the cutter diameter one should remember that in principle it should be 1.2 - 1.5 times bigger as the workpiece width.

When machining wide surfaces the best results can be obtained by positioning the cutter in such a way that the cutting width is 75% of the tool diameter.



Podstawowe wzory do obliczania parametrów skrawania przy frezowaniu:

The basic formula to calculate cutting parameters in milling:

$$V_c = \frac{\pi \times D_c \times n}{1000} \quad [\text{m/min}] \quad \text{Prędkość skrawania} \\ \text{Cutting speed}$$

D_c – Średnica głowicy frezowej [mm]
milling cutter diameter

$$V_f = f_z \times z \times n \quad [\text{mm/min}] \quad \text{Posuw minutowy} \\ \text{Feed / minute}$$

n – obroty wrzeciona
spindle rotations

$$f_z = \frac{V_f}{n \times z} \quad [\text{mm/z}] \quad \text{Posuw na ostrze} \\ \text{Feed / tooth}$$

v_f – posuw minutowy
feed / minute

$$f_n = \frac{V_f}{n} \quad [\text{mm/obr}] \quad \text{Posuw na obrót} \\ \text{Feed / revolution}$$

a_p – osiowa głębokość skrawania [mm]
axial cutting depth

$$P = \frac{a_p \times a_e \times v_f}{1000 \times Q_p} \quad [\text{kW}] \quad \text{Moc} \\ \text{Power requirement}$$

a_e – promieniowa głębokość skrawania [mm]
radial cutting depth

$$h_m = f_z \times a_p \quad [\text{mm}] \quad \text{Średnia grubość wióra} \\ \text{Average chip thickness}$$

Q_p – współczynnik zależny od rodzaju materiału obrabianego [cm³/min kW] (patrz tabela)
factor depending on workpiece material (see Table)

Dobierając parametry skrawania należy pamiętać że:

- parametry podane w tabelach odpowiadają piętnastominutowej trwałości ostrza
- średnia grubość wióra h_m nie powinna być mniejsza niż 0,1 mm, a przy zastosowaniu głowicy z $K_r = 45^\circ - 0,15$ mm.

Selecting the cutting parameters one should remember that:

- the parameters given in tables refer to 15-minute tooth life
- h_m average chip thickness should not be less than 0.1 mm and when using a cutter with $K_r = 45^\circ - 0,15$ mm.

Wartości współczynnika Q_p do obliczania mocy skrawania
Approximate power calculation - milling

Materiał <i>Material</i>		Twardość HB <i>Hardness HB</i>	Q_p cm ³ /min kW
Stal węglowa <i>Non-alloy carbon steel</i>	C < 0,25%	125	25
	C < 0,8%	150	23
	C < 1,4%	250	21
Stal niskostopowa <i>Low-alloy steel</i>	wyżarzona / <i>annealed</i>	125-200	21
	ulepszona / <i>toughened</i>	200-450	17
Stal wysokostopowa <i>High-alloy steel</i>	wyżarzona / <i>annealed</i>	150-250	19
	ulepszona / <i>toughened</i>	250-500	17
Stal nierdzewna <i>Stainless steel</i>	ferrytyczna, martenzytyczna / <i>ferr. mart.</i>	175-225	19
	austenityczna / <i>austenitic</i>	150-200	17
Staliwo <i>Cast steel</i>	niestopowe / <i>non-alloy</i>	225	27
	niskostopowe / <i>low-alloy</i>	150-250	24
	wysokostopowe / <i>high-alloy</i>	150-300	21
Stal ulepszona <i>Toughened steel</i>		> 50 HRC	10
Żeliwo ciągliwe <i>Malleable cast iron</i>	krótki wiór / <i>short chipping</i>	110-145	31
	długi wiór / <i>long chipping</i>	200-250	34
Żeliwo szare <i>Grey cast iron</i>	niskociągliwe / <i>low tensile</i>	150-225	49
	wysokociągliwe / <i>high tensile</i>	200-300	38
Żeliwo sferoidalne <i>Nodular cast iron</i>	ferrytyczne / <i>ferritic</i>	125-200	45
	perlityczne / <i>pearlitic</i>	200-300	31
Żeliwo białe <i>Chilled cast iron</i>		40-60 HRC	14
Stopy aluminium <i>Aluminium alloys</i>		100	82

2. Zalecane parametry skrawania / Recommended cutting data

Material <i>Material</i>	Twardość <i>Hardness</i>	NMP20	NMK20	NMK30	N210	N250	N300	N350	
		Posuw (mm/ząb) / <i>Feed (mm/tooth)</i>							
	HB	0,1-0,3	0,1-0,3	0,1-0,3	0,1-0,3	0,1-0,4	0,1-0,3	0,1-0,4	
		Prędkość skrawania (m/min) / <i>Cutting speed (m/min)</i>							
P Stal węglowa konstrukcyjna ogólnego przeznaczenia <i>Constructional carbon steel of general application</i> C 0,2% C 0,4% C 0,7%	135	330-230				280-200		250-150	
	180	300-200				240-150		200-100	
	230	240-150			150-90	190-110		150-90	
P Stal niskostopowa <i>Low-alloy steel</i> – wyżarzona / <i>annealed</i> – ulepszona / <i>hardened</i>	180	230-150			180-90	200-120		180-90	
	300	120-80			100-70	100-80		100-70	
P Staliwo <i>Cast steel</i> – niestopowe / <i>non-alloy</i> – niskostopowe / <i>low-alloy</i>	200	240-150			200-100	220-120		200-100	
	200	185-120			150-90	160-100		150-90	
M Stal nierdzewna <i>Stainless steel</i> – ferrytyczno-martenzytyczna <i>ferr.-mart.</i> – utwardzana wydzieleniowo <i>hardened</i> – austenityczna <i>austenitic</i>	200					160-120	190-140		
	330					80-60	100-80		
	200					140-120	170-140	140-120	
K Żeliwo szare <i>Grey cast iron</i>	180		270-160	240-120	280-180				
	200		200-110	180-90	220-120				
	150		160-100	140-80	180-100				
N Miedź i stopy <i>Copper and alloys</i>	60				220-120				
	110				1800-400				
S Stopy żaroodporne, stopy tytanu <i>Heat resistant steel, titanium alloys</i>	250								
H Stal hartowana (45-55 HRc) / <i>hard steel</i> Żeliwo / <i>cast iron</i>					180-100				

P Stal / *Steel*

M Stal nierdzewna / *Stainless steel*

K Żeliwo / *Cast iron*

N Stopy nieżelazne, aluminium
Non-ferritic alloys, aluminium alloys

S Stopy żaroodporne, stopy tytanu
Heat resistant steel, titanium alloys







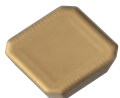

H Materiały hartowane
Hard materials

HC – gatunek pokrywany / *coated grade (PVD, CVD)*

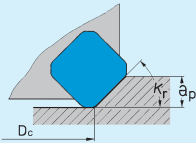
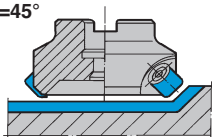
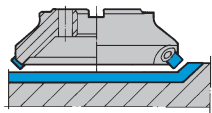
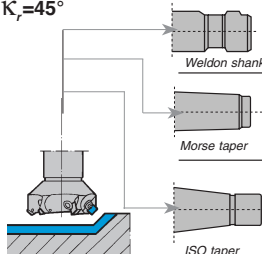

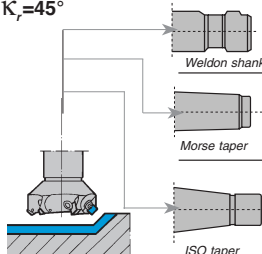
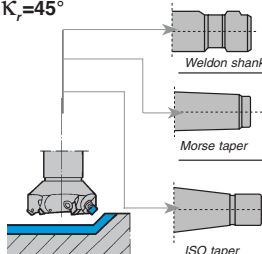
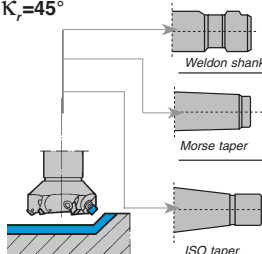
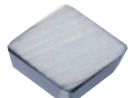
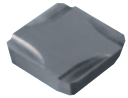

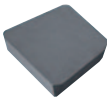
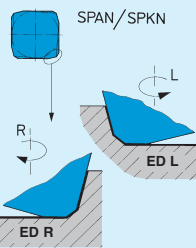
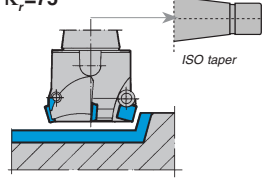
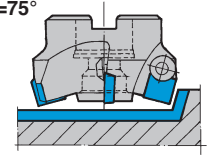

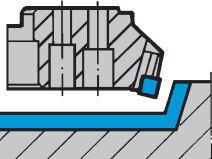
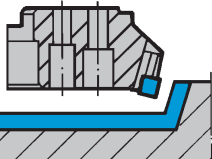
HW – gatunek niepokrywany / *uncoated grade*

SM25T	H10S	H15X	H20S	N	OR5000	5020	5135	5040	2003	5005
Posuw (mm/ząb) / Feed (mm/tooth)										
0,1-0,4	0,1-0,4	0,1-0,4	0,1-0,4	0,1-0,3	0,1-0,3	0,1-0,2	0,1-0,3	0,1-0,3	0,1-0,3	0,05-0,2
Prędkość skrawania (m/min) / Cutting speed (m/min)										
200-120 150-90 120-70					240-150 200-130 170-100	375-280 335-250	240-150 200-130 170-100	290-180 240-160	365-270	410-305
130-70 100-60					190-125 125-80	260-190 180-135	190-125 125-80	230-150 150-100		280-210 200-150
170-95 130-80					130-70 110-60		130-70 110-60			
135-110		50-80			140-80 120-60	250-180 235-170	140-80 120-60	175-100 155-100		275-200 250-185
	165-90	150-85	110-70	115-65					240-175	
	120-70	110-70	90-50	100-65					220-165	
	110-70	100-60	70-50	75-45					200-150	
	200-100								200-150	
	1800-400			1800-300					2000-300	
				40-25		75-55			70-55	
										50-30 80-75

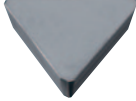
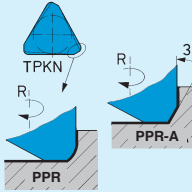

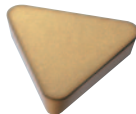
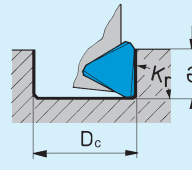
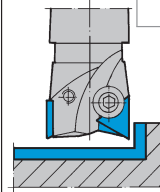
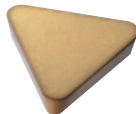
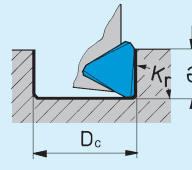
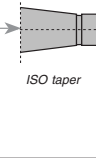
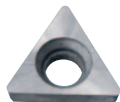
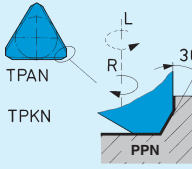
Płytki Inserts	Długość boku płytki Edge length l (G)	Zastosowanie Application	a_p max.	D_c (G)	Oznaczenie Designation	Ilość ostrzy Number of teeth	Geometria narzędzia Tool angles			
 SEAN / SEKN 1203..  SEKR  220.13-621-12¹⁾ -624-15²⁾	12.70		6.0	40	 $K_r=45^\circ$	220.130 -40-1	3	$\gamma_p = +20^\circ$ $\gamma_f = -9^\circ$		
				63		220.130 -50-1	4			
				63		220.130 -63-1	5			
			15.875	9.0	200	80	 $K_r=45^\circ$	220.130 -063 ¹⁾	5	$\gamma_p = +20^\circ$ $\gamma_f = -9^\circ$
								-080 ¹⁾	6	
								-100 ¹⁾	7	
	12.70		6.0	40	63	 $K_r=45^\circ$	220.130 -080-15 ²⁾	5	$\gamma_p = +20^\circ$ $\gamma_f = -9^\circ$	
							-100-15 ²⁾	6		
							-125-15 ²⁾	7		
	 220.13-621-12¹⁾ -624-15²⁾		12.70	40	63	 $K_r=45^\circ$	215.130 -3240.3 ¹⁾	3	$\gamma_p = +20^\circ$ $\gamma_f = -9^\circ$	
							-3250.3 ¹⁾	4		
							-3263.3 ¹⁾	5		
12.70		6.0	40	63	 $K_r=45^\circ$	215.130 -4040.2 ¹⁾	3	$\gamma_p = +20^\circ$ $\gamma_f = -9^\circ$		
						-4050.2 ¹⁾	4			
						-5063.2 ¹⁾	5			
12.70	6.0	40	80	 $K_r=45^\circ$	215.130 -3040.5 ¹⁾	3	$\gamma_p = +20^\circ$ $\gamma_f = -9^\circ$			
					-3050.5 ¹⁾	4				
					-4063.5 ¹⁾	5				
 SPAN / SPKN  SPKR  SPKR.. -PR1  SPGN / SPUN  LPKN	12.70		9.0	50	 $K_r=75^\circ$	215.27 -3050.5	3	$\gamma_p = +4^\circ$ $\gamma_f = 0^\circ$		
				80		215.27 -4063.5	4			
				80		215.27 -4080.5	5			
	12.70		9.0	50	80	 $K_r=75^\circ$	220.27 -050	3	$\gamma_p = +4^\circ$ $\gamma_f = 0^\circ$	
							-063	4		
							-080	5		
	12.70		9.0	80	500	 $K_r=75^\circ$	R/L 257.1-080-10	6	$\gamma_p = +7^\circ$ $\gamma_f = 0^\circ$	
							-100-10	8		
							-125-10	10		
							-160-10	12		
							-200-10	16		
							-250-10	20		
-315-10		26								
-400-10		34								
-500-10		34								
R/L 257.1-125-20		8								
15.785	12.0	500	125	 $K_r=75^\circ$	-160-20	10	$\gamma_p = +7^\circ$ $\gamma_f = 0^\circ$			
					-200-20	12				
					-250-20	16				
					-315-20	20				
					-400-20	26				
12.70	9.0	500	500	 $K_r=75^\circ$	R/L 257.20-125	12	$\gamma_p = +7^\circ$ $\gamma_f = 0^\circ$			
					-160	14				
					-200	18				
					-250	24				
					-315	30				
					-400	38				
					-500	50				

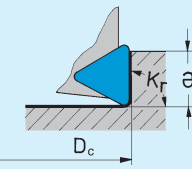
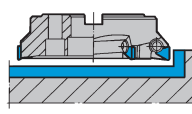
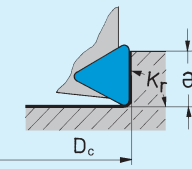
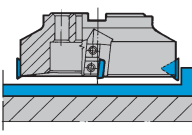
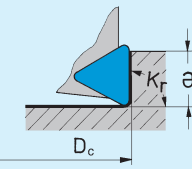
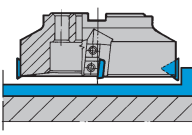

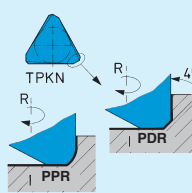
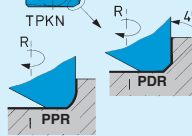
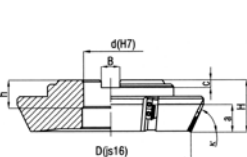

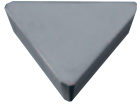
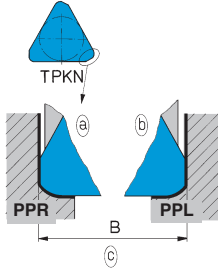
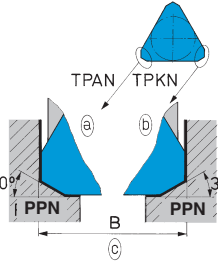
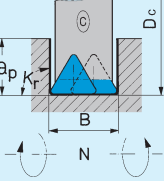
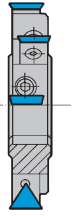
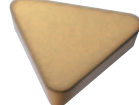
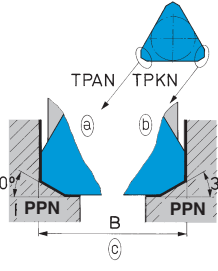
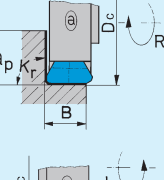
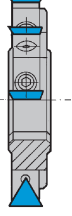
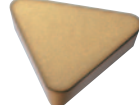
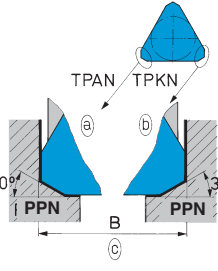
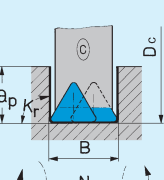
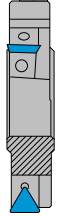
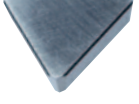
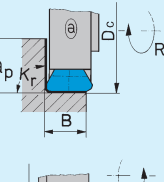
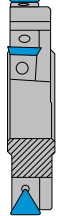
Application of inserts for milling
in other producers' tools

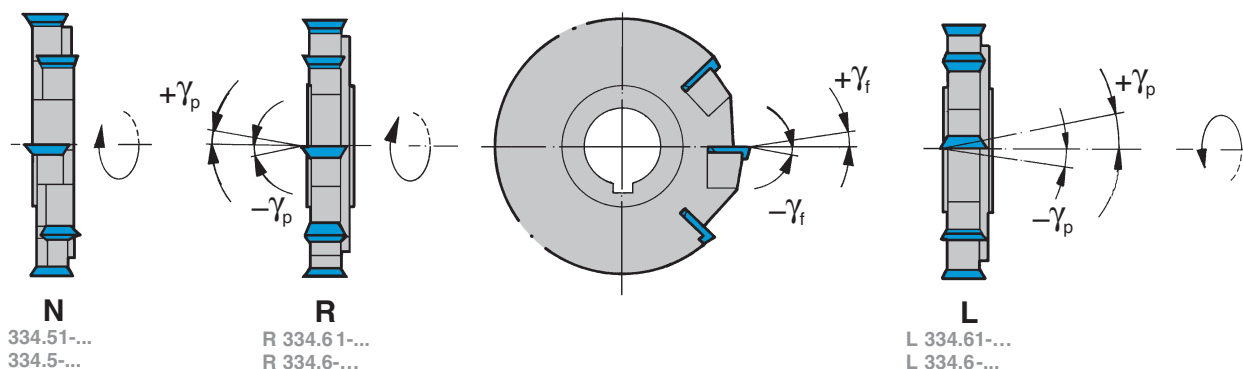
Płytki Inserts	Długość boku płytki Edge length (L)	Zastosowanie Application	a_p max.	D_c (2)	Oznaczenie Designation	Ilość ostrzy Number of teeth	Geometria narzędzia Tool angles
 TPKN	11.0		9.0	$K_r=90^\circ$ 	215.17 -1212.3 -1616.3 -2020.3 -2525.3 -3232.3 -3240.3 -3250.3	1	$\gamma_p = 0^\circ$
	16.5		14.5			2	
 TPGN / TPUN	11.0		9.0		215.17 -2016.2 -3020.2 -3025.2 -3028.2 -3040.2 -4040.2 -4050.2	1	$\gamma_f = 0^\circ$
	16.5		14.5			2	
	16.5		50			3	
 TPGN / TPUN	16.5		$K_r=90^\circ$ 	215.17 -3040.5 -3050.5 -4063.5 -4080.5	3	$\gamma_p = 0^\circ$	
					4		
					5		
					80		4
					80		5
 175.11-624¹⁾	16.5		$K_r=90^\circ$ 	220.17 -40 -50 -63-16 -63-22 -80 ¹⁾ -100 ¹⁾ -125 ¹⁾ -160 ¹⁾ -200 ¹⁾	3	$\gamma_p = 0^\circ$	
					14.5		3
	22.0	20.0		$K_r=90^\circ$ 	220.17 -40 -50 -63-16 -63-22 -80 ¹⁾ -100 ¹⁾ -125 ¹⁾ -160 ¹⁾ -200 ¹⁾	4	$\gamma_f = 0^\circ$
						5	
						6	
						7	
	22.0	20.0		$K_r=90^\circ$ 	259.1 -125 -160 -200 -250 -315	8	$\gamma_p = +5^\circ$
						10	
22.0	20.0		$K_r=90^\circ$ 	259.1 -125 -160 -200 -250 -315	12	$\gamma_f = +3^\circ$	
					16		
 TPKR..-PR1	22.0		$K_r=90^\circ$ 		R 259.130-125 R 259.140-125 R 259.145-125 R 259.150-125 R 259.160-125	8	K
						8	30°
						8	40°
						8	45°
						8	50°
8	60°						

Płytki Inserts	Długość boku płytki Edge length length l	Zastosowanie Application	a_p max.	D_c (\varnothing)	Oznaczenie Designation	Ilość ostrzy Number of teeth	Geometria narzędzia Tool angles				
 <p>TPKN</p>  <p>TPGN / TPUN</p>  <p>TPAN / TPKN</p>	11.0		25	100	$K_r=90^\circ$ 	334.51 -1012÷16 -1212÷16 -1612÷16	$\gamma_p = +4^\circ$ $\gamma_f = 0^\circ$				
	16.5		30	125				12÷16			
			50	160							
			25	100					18÷25	334.51 -1018÷25 -1218÷25 -1618÷25 -2018÷25 -2518÷25 -3118÷25	$\gamma_p = +5^\circ$ $\gamma_f = 0^\circ$
			30	125							
			50	160							
	60	200									
	80	250									
	100	315									
	 <p>TPGN / TPUN</p>  <p>TPAN / TPKN</p>	16.5		25	100	$K_r=90^\circ$ 	R/L 334.61 -100 -125 -160 -200 -250 -315	$\gamma_p = +5^\circ$ $\gamma_f = 0^\circ$			
		16.5		30	125				14.5		
				50	160						
60				200							
80				250							
100				315							
 <p>TPGN / TPUN</p>  <p>TPAN / TPKN</p>		16.5		25	100	$K_r=90^\circ$ 	334.5 -1018÷25 -1018÷25 -1218÷25 -1218÷25 -1618÷25 -2018÷25 -2518÷25 -3118÷25	$\gamma_p = +5^\circ$ $\gamma_f = 0^\circ$			
		16.5		25	100				18÷25		
				30	125						
				30	125						
				50	160						
				60	200						
	80	250									
	100	315									
	 <p>TPAN / TPKN</p>	16.5		25	100	$K_r=90^\circ$ 	R/L 334.6 -100 -100 -125 -125 -160 -200 -250 -315	$\gamma_p = +5^\circ$ $\gamma_f = 0^\circ$			
		16.5		25	100				14.5		
				30	125						
				30	125						
50				160							
60				200							
80		250									
100		315									



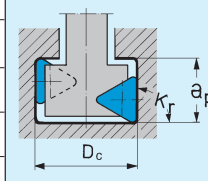
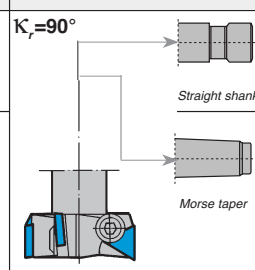
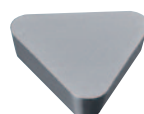
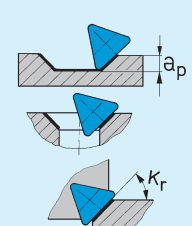
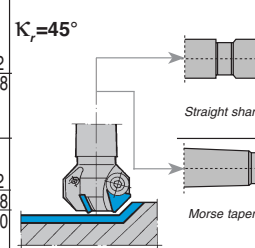

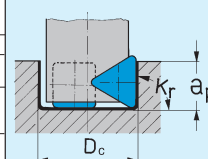
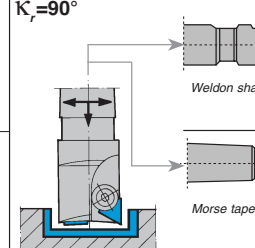

Application of inserts for milling in other producers' tools

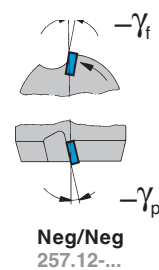
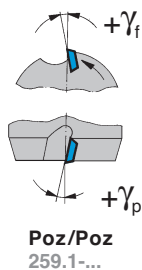
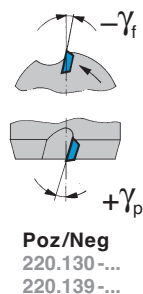

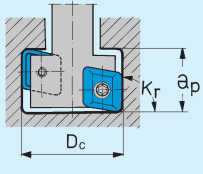
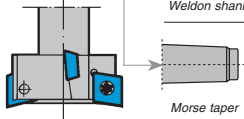
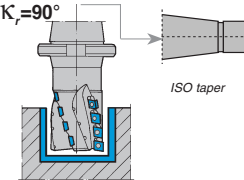
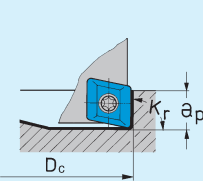
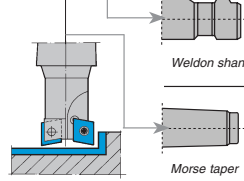
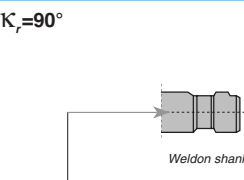
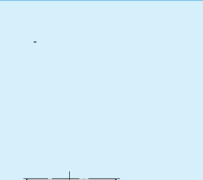
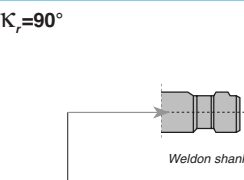

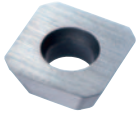
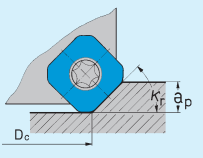
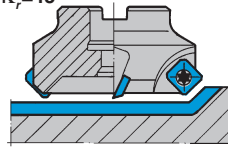

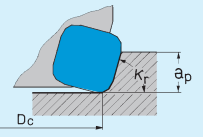
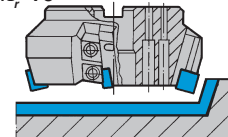
Płytki Inserts		Długość boku płytki Edge length (l _e)	Zastosowanie Application	a _p max.	D _c (2)	Oznaczenie Designation	Ilość ostrzy Number of teeth	Geometria narzędzia Tool angles			
 <p>TPGN TPUN</p>	 <p>TPMR</p>	11.0		14		<p>$K_r=90^\circ$</p> <p>215.13 -1618</p> <p>Straight shank</p> <p>Morse taper</p>	2	$\gamma_p = +3^\circ$			
		16.5		17.6					32	215.13 -2522	4
		11.0		22					60	215.13 -3228	
		16.5		28					32	215.13 -3236	
		22.0		14					32	215.13 -2018.2	
		33.0		17.6					32	215.13 -3022.2	
	22	32	215.13 -4028.2								
	28	32	215.13 -4036.2								
	35	32	215.13 -5042.2								
	38	32	215.13 -5048.2								
	44	32	215.13 -5054.2								
 <p>TPGN / TPUN</p>		16.5		9.0		<p>$K_r=45^\circ$</p> <p>215.17 -4505</p> <p>Straight shank</p> <p>Morse taper</p>	1	$\gamma_p = 0^\circ$			
	5:22	20:38							215.17 -4520	3	
	5:22	20:38							215.17 -4505.2		1
	20:38	32:50							215.17 -4520.2		
									215.17 -4532.2	3	
									215.17 -4532.2		
 <p>TPGN TPUN</p>	 <p>SPGN SPUN</p>	9.525		9.0		<p>$K_r=90^\circ$</p> <p>216.17 -2022.3</p> <p>Weldon shank</p> <p>Morse taper</p>	1+1	$\gamma_p = 0^\circ$			
		16.5		12.70					14.5	216.17 -2525.3	
		16.5		15.875					14.5	216.17 -2528.3	
		22.0		19.05					20.0	216.17 -3232.3	
		11.0		9.525					9.0	216.17 -3236.3	
		16.5		12.70					22	216.17 -3240.3	
		16.5		15.875					9.0	216.17 -3022.2	1+1
		22.0		19.05					14.5	216.17 -3025.2	
									14.5	216.17 -3028.2	
									20.0	216.17 -4032.2	
			216.17 -4036.2								
			216.17 -4040.2								

Odmianny geometrii ostrza głowic frezowych:
Different cutter geometries of milling cutters:

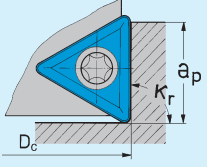
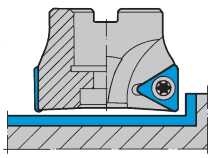

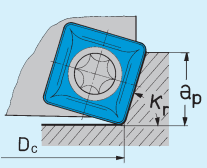
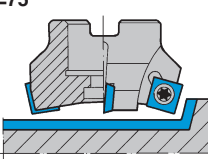
Płytki Inserts	Długość boku płytki Edge length [mm]	Zastosowanie Application	ap max.	Dc (∅)	Oznaczenie Designation	Ilość ostrzy Number of teeth	Geometria narzędzia Tool angles				
 CCMX	6.4		11	25	$K_r=90^\circ$  Weldon shank Morse taper	395.199 -1614.3 -1618.3 -2522.3 -3228.3 395.199 -2014.2 -2018.2 -3022.2 -4028.2	$\gamma_p = +2^\circ$ $\gamma_f = -4^\circ$				
	8.1		14	$K_r=90^\circ$  ISO taper				-40032032.5 -40040048.5 -50040048.5 -40050060.5 -50050072.5 -50063078.5 -50080097.5	4 12 16 16 20 24 24 25	geometria zmienna	
	9.7		18								
	12.9		22								
	6.4		11								25
	8.1		14								25
	9.7	18	25								
	12.9	22	25								
	6.4		5.0	12	$K_r=90^\circ$  Weldon shank Morse taper	217.199 -1212.3 -1616.3 -2020.3 -2525.3 -3232.3 217.199 -2016.2 -3020.2 -3025.2 -3032.2	$\gamma_p = +2^\circ$ $\gamma_f = -11^\circ$ $\div -5^\circ$				
	8.1		7.0	$K_r=90^\circ$  Weldon shank				-1212.3 -1616.3 -2020.3 -2525.3 -3232.3 -3236.3 -3240.3	1 2 3	$\gamma_p = +2^\circ$ $\gamma_f = -10^\circ$ $\div -5^\circ$	
	9.7		8.0								
	6.4		5.0								16
	8.1		7.0								16
	9.7		8.0								32
	6.4		5.0	$K_r=90^\circ$  Weldon shank Morse taper	216.199 -1212.3 -1616.3 -1618.3 -2020.3 -2022.3 -2525.3 -2528.3 -3232.3 -3236.3 -3240.3 216.199 -2012.2 -2016.2 -2018.2 -2020.2 -3022.2 -3025.2 -3028.2 -3032.2 -4036.2 -4040.2	1+1 1+1	$\gamma_p = +2^\circ$ $\gamma_f = -10^\circ$ $\div -5^\circ$				
8.1	5.0										
8.1	7.0										
9.7	7.0										
9.7	8.0										
9.7	8.0										
12.9	11.0		40								
6.4	5.0		12								
6.4	5.0		12								
8.1	7.0		12								
8.1	7.0		12								
9.7	8.0		12								
9.7	8.0	12									
12.9	12.70	11.0	40								

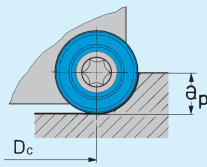
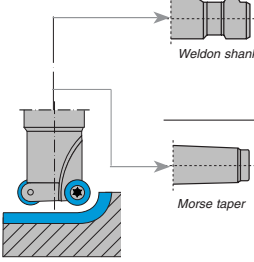
Płytki Inserts	Długość boku płytki Edge length [mm]	Zastosowanie Application	ap max.	Dc (∅)	Oznaczenie Designation	Ilość ostrzy Number of teeth	Geometria narzędzia Tool angles
 SEHX	12.70		6.0	50	$K_r=45^\circ$ 	220.139 -050 -063 -080 -100 -125 160	$\gamma_p = +20^\circ$ $\gamma_f = -9^\circ$
 SNKN	12.70		9.0	100	$K_r=75^\circ$ 	R/L 257.12 -100 -125 -160 -200 -250 -315 -400 500	$\gamma_p = -8^\circ$ $\gamma_f = -6^\circ 30'$
 SNGN SNUN						6 8 10 12 16 20 26 34	

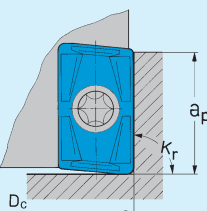
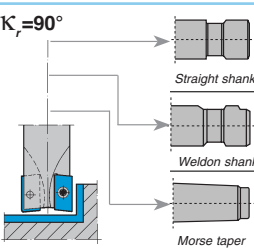
Płytki Inserts	Długość boku płytki Edge length (L)	Zastosowanie Application	a _p max.	D _c (2)	Oznaczenie Designation	Ilość ostrzy Number of teeth	Geometria narzędzia Tool angles	
 TCMT	16.5		14.5	40 ↓ 80	$K_r=90^\circ$ 	-040 -050 -063 -080	$\gamma_p = +4^\circ$ $\gamma_f = -5^\circ$ $\div 0^\circ$	
	22.0		20	80		4		
 SCMT	12.70		9.0	50 ↓ 80	$K_r=75^\circ$ 	-050 -063 -080	4	
						5		
 RPHT	8,0		4,0	12 ↓ 40 ↓ 16 ↓ 40		217.299 -1212.3 -1616.3 -2020.3 -2525.3 -3232.3 -3240.3	1 2 3 4	$\gamma_p = +5^\circ$ $\gamma_f = -5^\circ$ $\div 0^\circ$
	10,0		5,0			2		
	12,0		6,0			3		
	8,0		4,0			2		
	10,0		5,0			3		
	12,0		6,0			4		
	12,0		6,0			3		
	12,0		6,0			4		
	12,0		6,0			3		
	12,0		6,0			4		
 APFT	17.0		16.0	25 ↓ 40 ↓ 25 ↓ 40 ↓ 25 ↓ 40	$K_r=90^\circ$ 	217.699 -2525 -3232 -3240	2 3 4	$\gamma_p = +4^\circ$ $\div +8^\circ$ $\gamma_f = -10^\circ$ $\div -12^\circ$
						217.699 -2525.3 -3232.3 -3240.3	2 3 4	
						217.699 -3025.2 -3032.2 -4040.2	2 3 4	
						220.699 -040 -050 -063 -080 -100	4 5 6 7 8	
						220.599.. -40-25-22-16 -63-38-22-16 -80-38-22-16 -100-38-22-16 -125-38-22-16 -160-50-22-16 -200-50-22-16	3 4 5 6 7 8 10	
						217.699 -2525 -3232 -3240	2 3 4	
						217.699 -2525.3 -3232.3 -3240.3	2 3 4	
						217.699 -3025.2 -3032.2 -4040.2	2 3 4	
						220.699 -040 -050 -063 -080 -100	4 5 6 7 8	
						220.599.. -40-25-22-16 -63-38-22-16 -80-38-22-16 -100-38-22-16 -125-38-22-16 -160-50-22-16 -200-50-22-16	3 4 5 6 7 8 10	

Głowice QUADRI charakteryzują się:

możliwością zamocowania w jednej głowicy kilku kształtów płytek, tzn. w jednym gnieździe głowicy stosuje się płytki skrawające:

- oktagonalne **ODMT (ODKT)**
z łamaczem - **81**, - **41**, - **11**
- kwadratowe **SDMT (SDKT)**
z łamaczem - **81**, - **41**, - **21**, - **11**
- okrągłe **RDMT (RDGT)**
z łamaczem - **81**, - **41**, - **11**

które umożliwiają stosowanie głowicy do wszelkich typów frezowania czołowego i walcowo-czołowego. Dostępne są płytki z długością krawędzi skrawającej 12 oraz 15 mm,

łatwą wymianą płytek, pozwalającą na dokonanie tej operacji bez zdejmowania głowicy z wrzeciona obrabiarki,

eliminacją zabiegu ustawiania przy użyciu specjalnych przyrządów pomiarowych (gwarantowana bardzo wysoka dokładność wykonania gniazd),

dużą wydajnością,

małymi wymaganiami serwisowymi,

szerokim zakresem dostępnych średnic:
Ø 40 mm ÷ Ø 315 mm (inne na zamówienie),

możliwością zastosowania chłodzenia poprzez głowicę,

wysoką jakością narzędzi i płytek gwarantującą wysoką gładkość powierzchni, dokładność obróbki oraz stabilne warunki pracy,

dostępnością głowic w wersjach prawrotnych, jako zwykłe, drobnoostrzowe i o zwiększonym rozstawie ostrzy



QUADRI cutters offer:

a possibility to clamp several insert shapes in one cutter i.e. the following inserts are used in one seat:

- octagonal **ODMT (ODKT)** with - **81**, - **41**, - **11** chipbreakers
- square **SDMT (SDKT)** with - **81**, - **41**, - **21**, - **11** chipbreakers
- round **RDMT (RDGT)** with - **81**, - **41**, - **11** chipbreakers

which enable the user to apply the cutter in all types of face and end milling operations. Inserts with 12mm and 15 mm cutting edge are available,

easy replacement of inserts, without the need to take the cutter off the spindle,

elimination of positioning operations by means of special measuring devices (very high accuracy of seats guaranteed),

high productivity,

low maintenance requirements,

a wide range of available diameters:
Ø 40 mm ÷ Ø 315 mm (other can be tailor-made),

cooling may be done through the cutter,

high quality of tools and inserts ensuring surface smoothness, accuracy and stable working conditions,

cutters are available in right-hand versions as standard, fine pitch and coarse pitch.

W głowicach QUADRI mocowane są nowoczesne płytki wielo-
ostrzowe, w bogatej gamie kształtów i geometrii. Nowe płytki
posiadają szereg zalet, a w szczególności:

- możliwość właściwego doboru gatunku oraz kształtu płytki do określonej operacji, z podkreśleniem zalet nowych płytek ośmiokątnych **ODMT (ODKT) 12 / 15**,
- konstrukcja płytki pozwala na wykorzystanie jej do pracy w głowicy bez konieczności stosowania podkładek,
- wysoka precyzja wykonania płytek pozwalająca na uzyskanie wysokiej gładkości powierzchni obrabianej,
- optymalna geometria ostrzy umożliwiającą stosowanie wysokich parametrów obróbki,
- ekonomika eksploatacji oparta na wykorzystaniu nawet ośmiu krawędzi – w przypadku płytek **ODMT (ODKT)**
- zastosowanie nowych gatunków i powłok, które wpływają bezpośrednio na zwiększenie wydajności i trwałości narzędzi.

Modern indexable inserts, in a variety of shapes and geometries, are clamped in QUADRI cutters. New inserts offer a lot of advantages, in particular:

- possibility to select appropriate insert grade and shape for the given operation, with special emphasis on benefits offered by new octagonal inserts **ODMT (ODKT) 12 / 15**,*
- insert construction allows the user to clamp it in the cutter without using anvils,*
- high precision of inserts leads to high surface smoothness,*
- optimal edge geometry enables the user to machine at high cutting data,*
- efficient operation owing to application of many edges, in case of **ODMT (ODKT)** even eight times higher,*
- use of new grades and coatings, which directly affect productivity and tool life.*









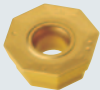

Płytki wieloostrowe do głowic QUADRI dostępne są w czterech różnych geometriach:

- geometria – 81 – najbardziej wszechstronna i trwała, pozwalająca na całkowicie bezpieczne wykonanie obróbki wstępnej,
- geometria – 41 – do prac średniodokładnych i dokładnych,
- geometria – 21 – z krawędzią skrawającą, przeznaczoną szczególnie do obróbki materiałów miękkich i do maszyn o niewielkiej mocy,
- geometria – 11 – z najbardziej ostrą krawędzią skrawającą przeznaczoną do frezowania stopów lekkich.

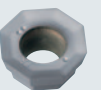
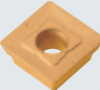
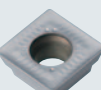
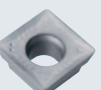
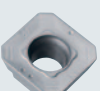
Indexable inserts for QUADRI cutters are available in four different geometries:

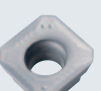





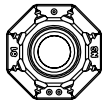
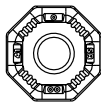
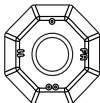

- 81 geometry – the most universal and long life, completely safe roughing
- 41 geometry – for semi-finishing and finishing
- 21 geometry – with a cutting edge, designed mainly for soft materials and low power machines
- 11 geometry – the sharpest cutting edge, designed for milling of light alloys

Do głowic QUADRI oferujemy cztery rodzaje płytek wieloostrowych:
The QUADRI cutters can be fitted with:

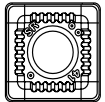
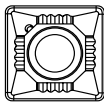
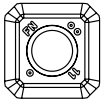
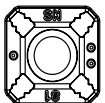
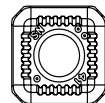
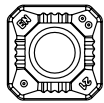
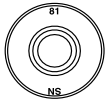

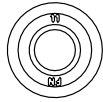
<p>Oktagonalne Octagonal</p>		<p>ODMT 120508 SN-81 ODMT 150608 SN-81</p>		<p>ODKT 1205AD SR-41 ODKT 1506AD SR-41</p>		<p>ODKT 1205AD FR-11</p>
<p>Kwadratowe z promieniem Square with corner radius</p>		<p>SDMT 120508 SN-81 SDMT 150608 SN-81</p>		<p>SDKT 1205PD SR-41</p>		<p>SDMT 120508 EN-21 SDMT 150608 EN-21</p>
<p>Kwadratowe z pomocniczą krawędzią przyłożenia Square inserts with wiper edges</p>		<p>SDMT 1205AE SN-81 SDMT 1506AE SN-81</p>		<p>SDKT 1205AE SN-41</p>		<p>SDMT 1205AE EN-21 SDMT 1506AE EN-21</p>
<p>Okrągłe Round</p>		<p>RDMT 120500 SN-81 RDMT 120500 SN-F8-81 RDMT 150600 SN-81</p>		<p>RDGT 120500 SN-F8-41</p>		<p>RDGT 120500 FN-11</p>

Nowatorskie rozwiązanie powoduje, że głowice QUADRI dzięki swojej konstrukcji są narzędziami wszechstronnymi i uniwersalnymi, pracującymi w każdym warunkach.

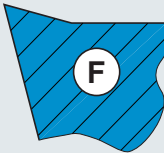



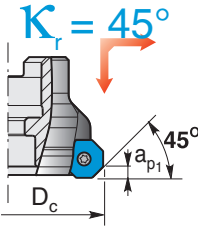
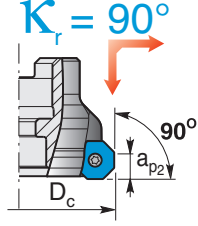
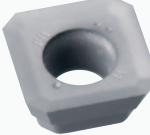
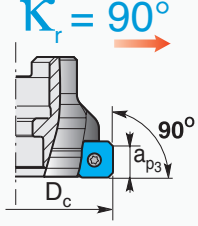
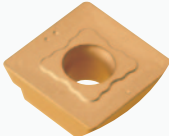
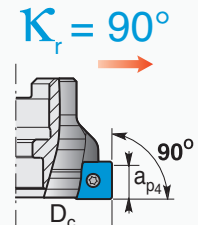

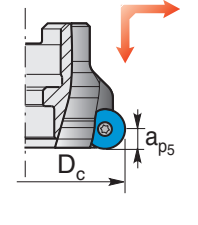
Innovative construction makes QUADRI cutters universal tools that work in any conditions.



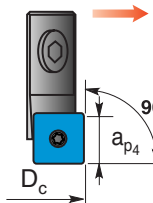
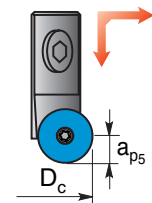
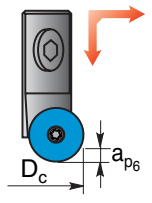
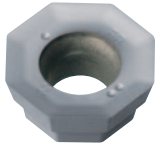

		Większy posuw / Fast feed		Mniejszy posuw / Slow feed	
Posuw f_z (mm/z) / Feed (mm/tooth)		0,40 ÷ 0,15		0,25 ÷ 0,08	
Tolerancja wykonania / Tolerance class		M		K/G	
Obróbka / Machining		Zgrubna Roughing		Średniodokładna, dokładna Semi-finishing, finishing	
GEOMETRIA, KSZTAŁT I WIELKOŚĆ PŁYTKI GEOMETRIES SHAPE AND SIZE OF INSERT MATERIAŁ MATERIAL		- 81	- 41	- 21	- 11
		 ODMT 12/15	 ODKT 12/15	 ODKT 12	
		 SDMT 12/15	 SDKT 12	 SDMT 12/15	 SDKT 12
		 SDMT 12/15	 SDKT 12	 SDMT 12/15	
	 RDMT 12/15	 RDGT 12		 RDGT 12	
STAL / STEEL		5020 OR5000, 5135	5020 OR5000, 5135	5020 OR5000, 5135	
STAL NIERDZEWNA / STAINLESS STEEL		5020 OR5000, 5135	OR5000, 5135	OR5000, 5135 2003	
ŻELIWO / CAST IRON		2003	2003	2003	
STOPY ALUMINIUM / ALUMINIUM ALLOYS					2003
STOPY ŻAROODPORNE / HEAT-RESISTANT ALL.			2003 5020	2003 5020	2003
Postać krawędzi skrawającej Cutting edge profile					

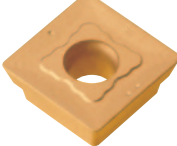
		Dostępna ilość ostrzy / No. of teeth					
		8	4	4	4	4	6
		Maks. głębokość skrawania $a_{p...}$ (mm) / Max. cutting depth					
		a_{p_1}	a_{p_2}	a_{p_3}	a_{p_4}	a_{p_5}	a_{p_6}
		$K_r = 45^\circ$	$K_r = 90^\circ$	$K_r = 90^\circ$	$K_r = 90^\circ$		
Długość boku płytki Insert side length							
12		3	7	9	10	6	3
12	G	3	7	9	10	6	3
12		3	7	9	10	6	3
15		4	9	11	12	8	4
		ODKT 12/15 ODMT 12/15	ODKT 12/15 ODMT 12/15	SDKT 12 SDMT 12/15	SDKT 12 SDMT 12/15	RDGT 12 RDMT 12/15	RDGT 12 RDMT 12/15

Płytki Inserts		Zastosowanie Application	$a_{p\ max}$	D_c (\varnothing)	Oznaczenie Designation	Ilość ostrzy Teeth no.	Geometria narzędzia Tool geometries	
 ODKT 12/15 ODMT 12/15	12	 $K_r = 45^\circ$	3	50	OC-12/050-05-ALC-R	5	Poz. / Neg.	
				63	OC-12/063-06-ALC-R	6		
	15			4	80	OC-12/080-08-ALC-R		8
					100	OC-12/100-10-ALC-R		10
	12		 $K_r = 90^\circ$	7	125	OC-12/125-12-ALC-R		12
					160	OC-12/160-12-AL-R		12
15			9	200	OC-12/200-14-AL-R	14		
				40	OC-12/040-03-AL-R	3		
 SDKT 12 SDMT 12/15	12	 $K_r = 90^\circ$	9	50	OC-12/050-04-ALC-R	4	$\gamma_p = +8^\circ$ $\div +13^\circ$	
				63	OC-12/063-05-ALC-R	5		
				80	OC-12/080-06-ALC-R	6		
	15			11	100	OC-12/100-07-ALC-R		7
					125	OC-12/125-08-ALC-R		8
160	OC-12/160-10-AL-R	10						
 SDKT 12 SDMT 12/15	12	 $K_r = 90^\circ$	10	63	OC-12/063-04-AL-R	4	$\gamma_i = -7^\circ$ $\div -12^\circ$	
				80	OC-12/080-04-AL-R	4		
				100	OC-12/100-05-AL-R	5		
	15			12	125	OC-12/125-06-AL-R		6
					160	OC-12/160-08-AL-R		8
 RDGT 12 RDMT 12/15	12		6	63	OC-15/063-05-ASC-R	5		
				15		8		80
	12		3					100
				15		4		125
	12		3					160
				15		4		200

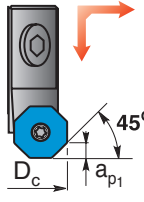
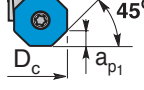
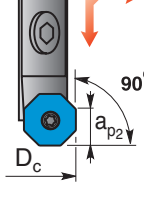
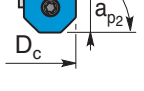

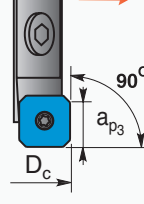
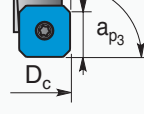
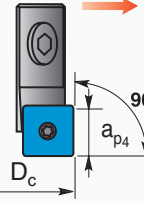
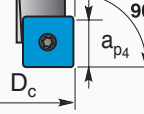
		Dostępna ilość ostrzy / No. of teeth					
		8	4	4	4	4	6
		Maks. głębokość skrawania $a_{p...}$ (mm) / Max. cutting depth					
		a_{p_1}	a_{p_2}	a_{p_3}	a_{p_4}	a_{p_5}	a_{p_6}
Długość boku płytki Insert side length ↓							
		$K_r = 45^\circ$	$K_r = 90^\circ$	$K_r = 90^\circ$	$K_r = 90^\circ$		
							
12		3	7	9	10	6	3
15		4	9	11	12	8	4
							
		ODKT 12/15 ODMT 12/15	ODKT 12/15 ODMT 12/15	SDKT 12 SDMT 12/15	SDKT 12 SDMT 12/15	RDGT 12 RDMT 12/15	RDGT 12 RDMT 12/15

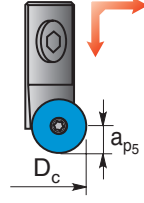
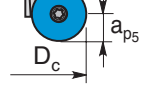
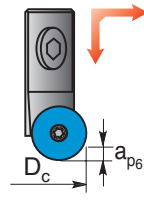
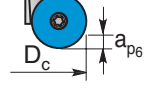
Płytki Inserts		Zastosowanie Application	$a_{p\max}$	D_c (\varnothing)	Oznaczenie Designation	Ilość ostrzy Teeth no.	Geometria narzędzia Tool geometries	
	12	$K_r = 45^\circ$ 	a_{p_1} 3	160 200 250 315	160 C10R-CA 045 D 12 200 C12R-CA 045 D 12 250 C15R-CA 045 D 12 315 C18R-CA 045 D 12	10 12 15 18	Poz. / Neg.	
	15	$K_r = 45^\circ$ 	4					
	12	$K_r = 90^\circ$ 	a_{p_2} 7					
	15	$K_r = 90^\circ$ 	9					
	 	12	$K_r = 90^\circ$ 					a_{p_3} 9
		15	$K_r = 90^\circ$ 					11
12		$K_r = 90^\circ$ 	a_{p_4} 10					
15		$K_r = 90^\circ$ 	12					
	12	$K_r = 90^\circ$ 	a_{p_5} 6	160 200 250 315	160 C10R-CA 045 D 15 200 C12R-CA 045 D 15 250 C15R-CA 045 D 15 315 C18R-CA 045 D 15	10 12 15 18	$\gamma_p = +8^\circ$ $\div +13^\circ$ $\gamma_f = -7^\circ$ $\div -12^\circ$	
	15	$K_r = 90^\circ$ 	8					
	12	$K_r = 90^\circ$ 	a_{p_6} 3					
	15	$K_r = 90^\circ$ 	4					



Podział głowic ze względu na liczbę ostrzy:

- oferujemy głowice QUADRI do obróbki różnych materiałów, można je montować na wielu typach obrabiarek pracujących w odmiennych warunkach i przy różnych parametrach ze względu na liczbę ostrzy.

Produkowane są:

– Głowice jednolite:

Głowice drobnoostrzowe
Fine pitch cutters
OC – 12/050 ÷ 200...

Głowice normalne
Normal pitch cutters
OC – 12/040 ÷ 200...
OC – 15/063 ÷ 200...

Głowice o zmniejszonej liczbie ostrzy
Coarse pitch cutters
OC – 12/063 ÷ 160...

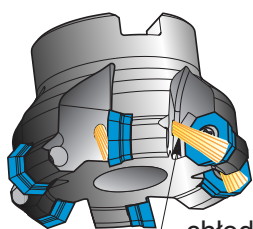

chłodzenie
coolant

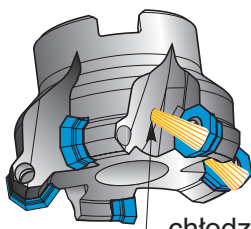

chłodzenie
coolant

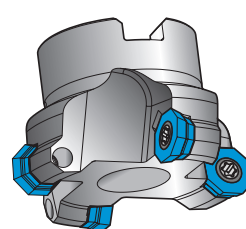

Zalecane przy: / Recommended with:

- wysokich posuwach,
- zwiększonej precyzji wykonania oraz wyższej dokładności przy małych profilach obrabianych.
- high feeds,
- increased workmanship precision and higher accuracy with small workpiece profiles.

Zalecane przy: / Recommended with:

- normalnych parametrach
- standard parameters

Zalecane do: / Recommended with:

- obróbki stali nierdzewnych i stopów aluminium
- Charakteryzują się:
- mniejszym zużyciem energii,
- zredukowaną liczbą zębów.
- machining of stainless steel and aluminium alloys
- Typical features:
- lower energy consumption,
- reduced number of teeth.

Głowice drobnoostrzowe oraz głowice normalne w zakresie średnic $\varnothing 50 \text{ mm} \div \varnothing 125 \text{ mm}$ posiadają kanały na ciecz chłodzącą, kierujące strumień chłodziwa bezpośrednio na krawędź skrawającą.

Fine pitch cutters and normal pitch cutters in the range of $\varnothing 50 \text{ mm} \div \varnothing 125 \text{ mm}$ have coolant channels that direct coolant flow onto the cutting edge.

– Głowice z wymiennymi wkładkami: / Cutters with cartridges:

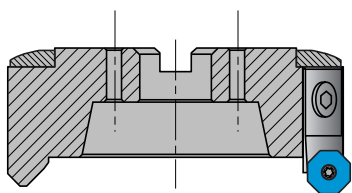

$\varnothing 160 \text{ mm} \div 250 \text{ mm}$

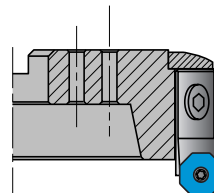

$\varnothing 315 \text{ mm}$

- Zakres średnic $\varnothing 160 \text{ mm} \div \varnothing 315 \text{ mm}$ / Range of diameters $\varnothing 160 \text{ mm} \div \varnothing 315 \text{ mm}$
- Możliwość stosowania wkładek do płytek 12 i 15 / Cartridges can be used for 12 and 15 inserts

Głowice jednolite: / Solid cutters:

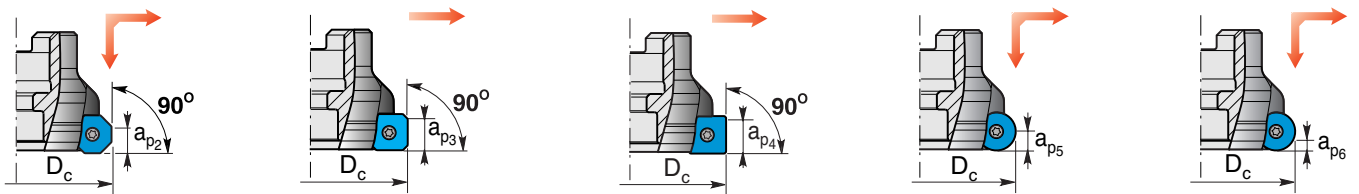
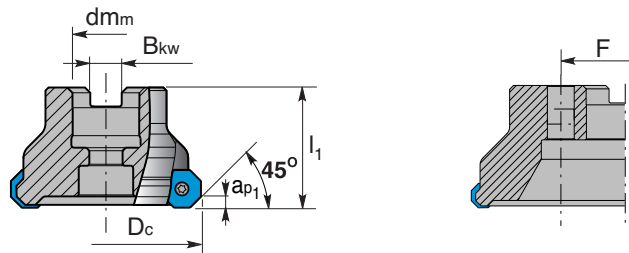

- Zakres średnic $\varnothing 40 \text{ mm} \div \varnothing 200 \text{ mm}$ / Range of diameters $\varnothing 40 \text{ mm} \div \varnothing 200 \text{ mm}$
- Możliwość wyboru głowicy z chłodzeniem poprzez korpus głowicy / Cutter with cooling through the cutter body can be selected

Głowice z wymiennymi wkładkami: / Cutters with cartridges:

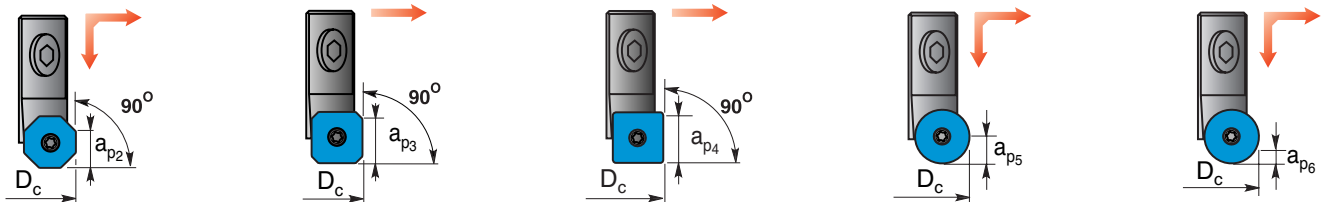
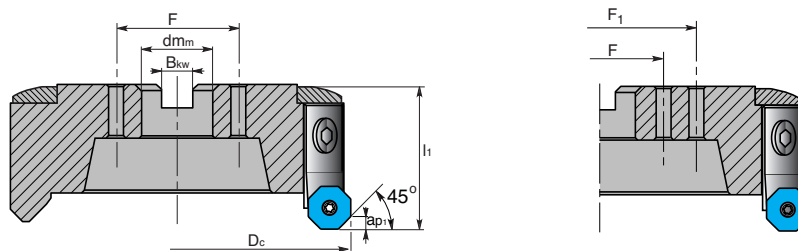

- Zakres średnic $\varnothing 160 \text{ mm} \div \varnothing 315 \text{ mm}$ / Range of diameters $\varnothing 160 \text{ mm} \div \varnothing 315 \text{ mm}$
- Wymienne wkładki pozwalające zastosować różne wielkości płytek (12 i 15) w jednym korpusie głowicy / Cartridges enable the user to use various insert sizes (12 and 15) in one cutter body

Uwagi eksploatacyjne:

- ❑ na szczególną uwagę zasługują płytki ośmiokątne **ODMT (ODKT)**, wysoce ekonomiczne dzięki swojej geometrii, pozwalające frezować powierzchnie pod kątem 45° na ośmiu krawędziach z maksymalną głębokością skrawania 4 mm (możliwe jest również zwiększenie głębokości do 9 mm stosując jednocześnie dwie krawędzie skrawające),
- ❑ płytkami kwadratowymi z promieniem naroża **SDMT (SDKT)** można przeprowadzić operację planowania oraz frezować powierzchnię pod kątem 90° przy użyciu 4 krawędzi tnących (głębokość może dochodzić do 12 mm przy płytkach l (d) = 15),
- ❑ oprócz płytek kwadratowych z promieniem oferujemy płytki kwadratowe z pomocniczą krawędzią skrawającą, stosowane do operacji planowania oraz frezowania powierzchni pod kątem 45°. Mogą być montowane w tym samym korpusie głowicy, a w stosunku do płytek z promieniem wykazują większą trwałość i wytrzymałość,
- ❑ na miano najbardziej wytrzymałych zasługują płytki okrągłe **RDMT i RDKT**, pozwalające na frezowanie profilowe (kształtowe).
Oferowane są dwa zasadnicze rozmiary płytek:
d = 12,70 – dla głębokości frezowania do 6 mm,
d = 15,875 – dla głębokości frezowania do 8 mm.

Operational suggestions:

- ❑ *Special attention should be paid to **ODMT (ODKT)** octagonal inserts, very economical owing to their geometry, which can be applied in milling of surfaces at 45° in eight edges with maximum cutting depth of 4 mm (it is also possible to increase depth to 9 mm using two cutting edges at the same time),*
- ❑ ***SDMT (SDKT)** square inserts with corner radius may be used for planning and milling at 90° using 4 cutting edges (depth can reach up to 12 mm with inserts l (d) = 15),*
- ❑ *In addition to square inserts with corner radius we also offer square inserts with wiper edges, used for planning and milling at 45°. They can be clamped in the same Quadri cutter body and demonstrate higher wear resistance and tool life compared to inserts with corner radius,*
- ❑ ***RDMT and RDKT** inserts are the most wear resistant, and can be used for profile milling.*

*Two standard insert sizes are available:
d = 12.70 – for milling depth up to 6 mm,
d = 15.875 – for milling depth up to 8 mm.*

Zakres zalecanych, maksymalnych prędkości obrotowych dla głowic i frezów trzpieniowych QUADRI (Dc = Ø 40 ÷ 160)
Recommended range of maximum rotation speed for QUADRI milling and shank cutters:

Dc (mm)	40	50	63	80	100	125	160
n _{max} (obr/min) (rev/min)	11000	9800	8000	6500	5500	4500	3500

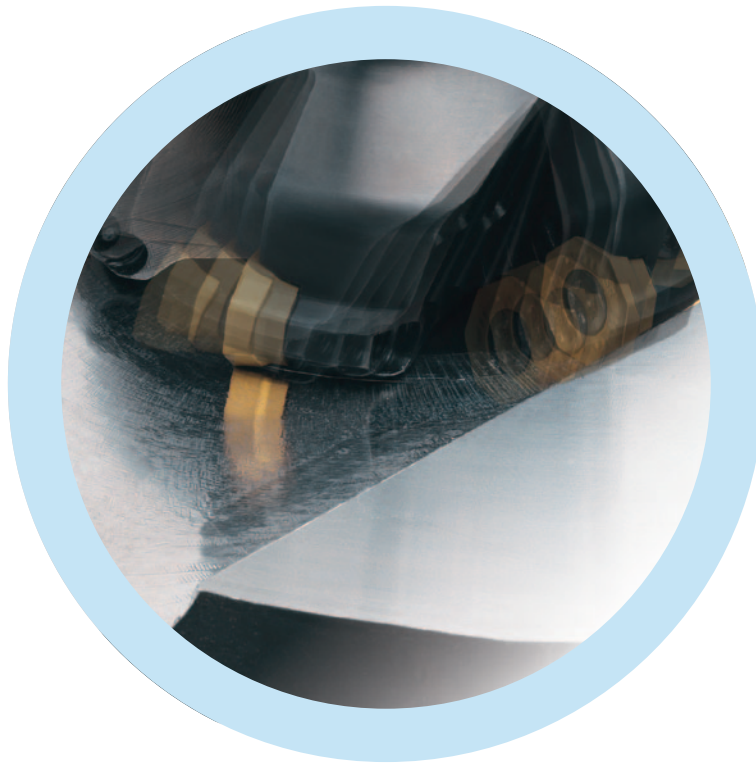

Średnice (D_c) i wysokość (I_1) głowic / Cutter diameters (D_c) and heights (I_1)

Dla określonej średnicy D_c wysokość I_1 nie zmienia się bez względu na zastosowaną płytkę (przykład poniżej):
 For a given D_c diameter, I_1 height does not change irrespective of an insert (example below):

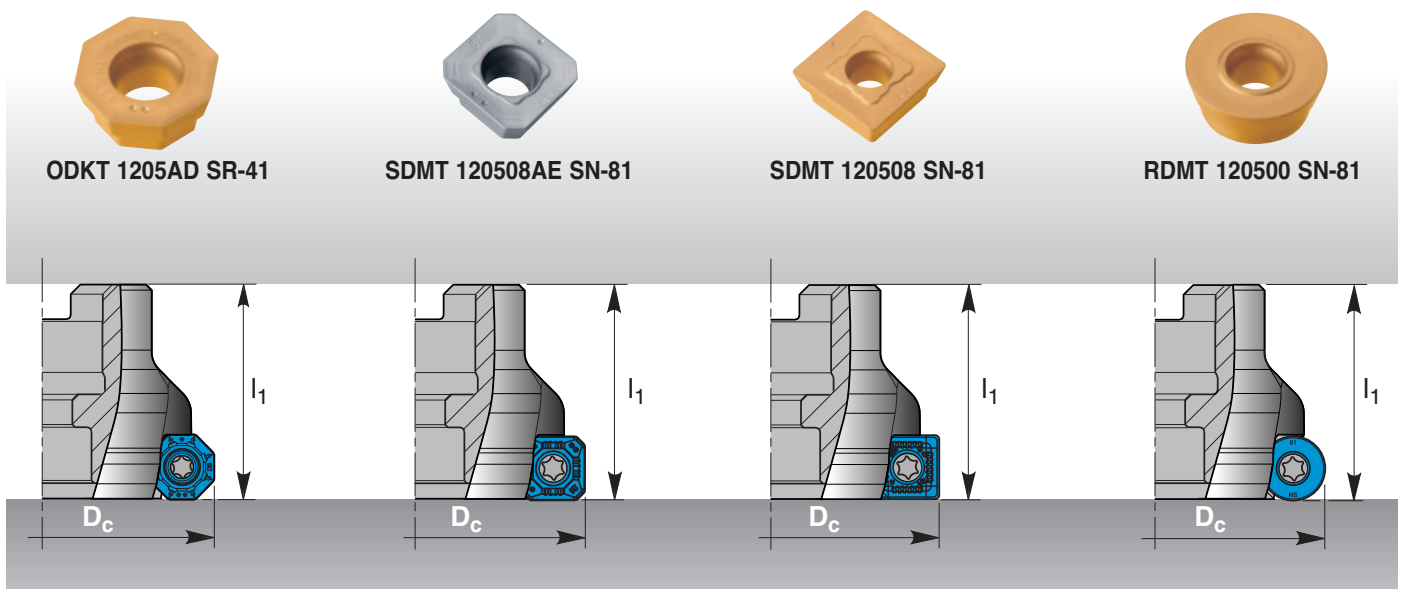

Zwiększona grubość płytek $s = 5,56$ mm lub $s = 6,35$ mm wpływa na wzrost wytrzymałości, poprawia sztywność i wydłuża okres użytkowania narzędzia.

Increased insert thickness $s = 5.56$ mm or $s = 6.35$ mm improves wear resistance, stiffness and tool life.

Frezy **ECO 45** charakteryzują się ustawieniem krawędzi skrawającej płytki wielostrzałowej pod kątem 45° do obrabianego materiału.

ECO 45 mills have a 45° angle between the insert cutting edge and the workpiece.

Frezy te nadają się do obróbki:

- stali
- stali nierdzewnych
- żeliw
- stopów ogniotrwałych
- stopów aluminium i tytanu

The mills are designed for machining of:

- steel
- stainless steel
- cast iron
- heat-resistant alloys
- aluminium and titanium alloys

- **Główce jednolite:**
- **Solid cutters:**

Główce normalne:
Normal pitch cutters:

GQ - 12/040 ÷ 160...

GQ - 15/050 ÷ 160...

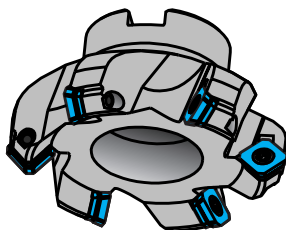

Główce o zmniejszonej liczbie ostrzy:
Coarse pitch cutters:

GQ - 12/063 ÷ 100...

- mniejsze zużycie mocy
- lower power consumption

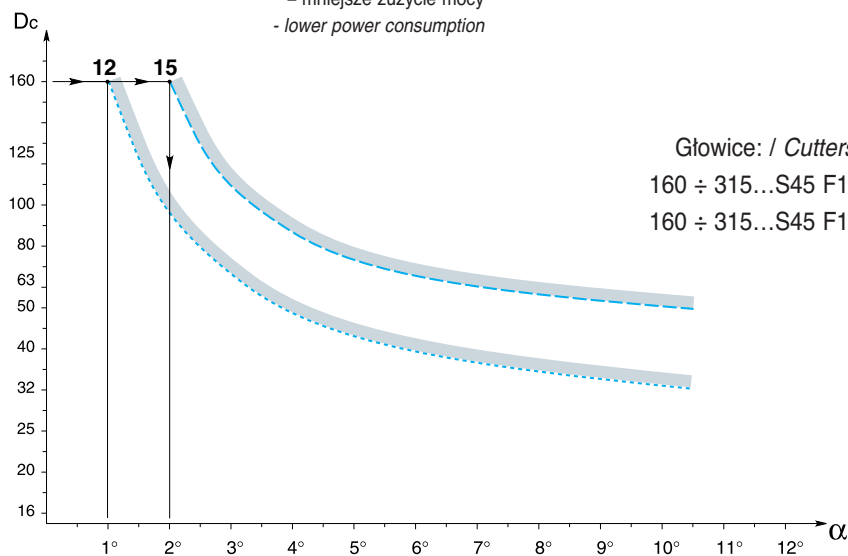
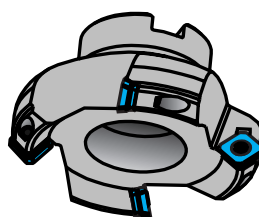

- **Główce z wymiennymi wkładkami:**
- **Cutters with cartridges:**

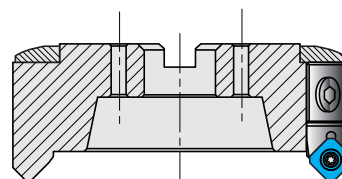

Główce: / Cutters:

160 ÷ 315...S45 F12

160 ÷ 315...S45 F15

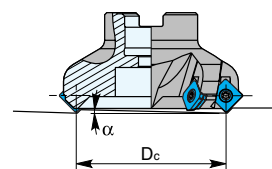

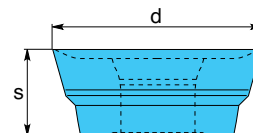

Powiększony wymiar s płytek powoduje zwiększenie ich trwałości.
Increased s insert size leads to higher wear resistance.

Grubość płytki Insert thickness	
d	s
9,95	3,97
12,70	5,56
15,875	6,35

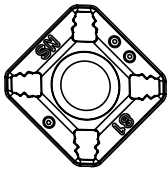
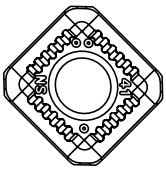
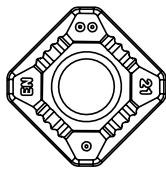
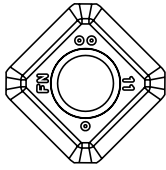

Zakres zalecanych, maksymalnych prędkości obrotowych dla głowic i frezów trzpieniowych ECO 45 (Dc = Ø 32 ÷ 160)
Recommended range of maximum rotation speed for ECO 45 milling and shank cutters:

Dc (mm)	32	40	50	63	80	100	125	160
n _{max} (obr/min) (rev/min)	11800	11200	9700	7900	6600	5500	4400	3600

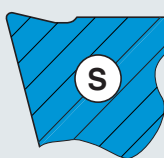
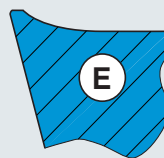
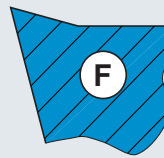
					
		Większy posuw / Fast feed		Mniejszy posuw / Slow feed	
Posuw f_z (mm/z) / Feed (mm/tooth)		0,40 ÷ 0,15	0,25 ÷ 0,10	0,20 ÷ 0,08	0,20 ÷ 0,05
Tolerancja wykonania / Tolerance class		M	K	M	K
Obróbka / Machining		Zgrubna Roughing	Średniodokładna Semi-finishing	Dokładna Finishing	Średniodokł., dokładna Semi-finishing, finishing
GEOMETRIA, KSZTAŁT I WIELKOŚĆ PŁYTKI GEOMETRIES SHAPE AND SIZE OF INSERT		- 81	- 41	- 21	- 11
		 SDMT 12/15	 SDKT 12	 SDMT 12/15	 SDKT 12
MATERIAŁ MATERIAL					
STAL / STEEL		OR5000, 5135 5020	OR5000, 5135 5020	5020 OR5000, 5135	
STAL NIERDZEWNA / STAINLESS STEEL		OR5000, 5135 5020	OR5000, 5135 5020	OR5000, 5135 2003	
ŻELIWO / CAST IRON		2003	2003	2003	
STOPY ALUMINIUM / ALUMINIUM ALLOYS					2003
STOPY ŻAROODPORNE / HEAT-RESISTANT ALL.			2003 5020	2003 5020	2003
Postać krawędzi skrawającej Cutting edge profile					



1. Wybór płytki / Choice of insert

Poniższa tabela pozwala na wybór najbardziej odpowiedniej płytki skrawającej biorąc pod uwagę:

- materiał obrabiany,
- posuw na ząb,
- geometrię ostrza płytki,
- gatunek węgla spiekanego.

The table below enables you to choose to the most suitable insert for your use, taking into account:

- the material,
- the feed per tooth,
- the geometry of the cut,
- the grade.

Posuw (mm/z) fz / Feed (mm/tooth)		0,60 do/to 0,10						0,30 do/to 0,05					
Geometria Geometries		Obr. zgrubna Roughing						Obr. średniodokładna, dokładna Semi-finishing, finishing					
		- 71						- 31					
Materiał Materials		Ø 10 - 12 - 16 - 20 - 25 - 32 - 40 - 50						Ø 10 - 12 - 16 - 20 - 25 - 32 - 40 - 50					
Stal Steel	PVD 5020												
	PVD 5040												
	CVD 5135												
Stal nierdzewna Stainless steel	PVD 5040												
	CVD 5135												
	PVD 5005												
Żeliwo Cast iron	PVD 5040												
	PVD 5005												
	PVD 2003												
Stopy aluminium Aluminium alloys	PVD 5040												
	PVD 5005												
	PVD 2003												
Stopy tytanu Titanium alloys	PVD 5040												
	PVD 5005												
	PVD 2003												
Postać krawędzi skrawającej Cutting edge geometries													

2. Specyfikacja obróbki / Milling specifications

Dokładność obróbki: / Machining tolerances:

Średnica nominalna freza Nominal milling cutter diameter D_3 (mm)	Promień ostrza r_E (mm) Radius of edge r_E (mm)	Zgrubna - geometria - 71 Roughing - geometry - 71	Średniodok[]- geometria - 31 Semi-finishing - geometry - 31
Ø 12	6		6 ⁰ _{-0,09}
Ø 16	8	8 ^{+0,03} _{-0,12}	8 ⁰ _{-0,09}
Ø 20	10	10 ^{+0,03} _{-0,12}	10 ⁰ _{-0,09}
Ø 25	12,5	12,5 ^{+0,06} _{-0,15}	12,5 ⁰ _{-0,09}
Ø 32	16	16 ^{+0,1} _{-0,18}	16 ^{+0,02} _{-0,10}
Ø 40	20	20 ^{+0,18} _{-0,25}	
Ø 50	25	25 ^{+0,22} _{-0,3}	

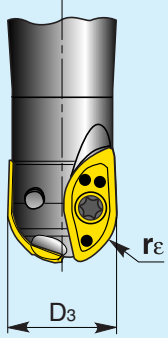

Oznaczenie ostrzy skrawających płytki. / Number of cutting edges.

Każdy frez używa tylko jednego rodzaju płytki z dwoma ostrzami skrawającymi oznaczonymi w poniższy sposób:
Each milling cutter uses one type of insert with two cutting edges:

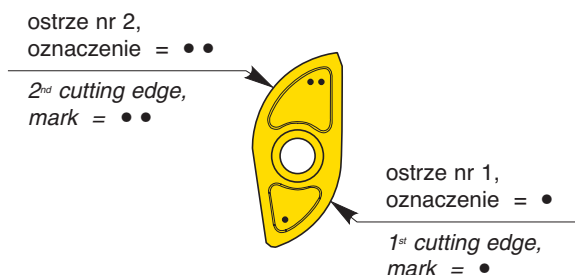

Montaż płytki. / Fitting inserts.

Podczas montowania płytki w gnieździe należy zwrócić uwagę aby znak na płytce pokrywał się ze znakiem na korpusie freza.
For correct insert fitting, line up the identical marks on both the cutter and insert.

• z / with • lub / and •• z / with ••

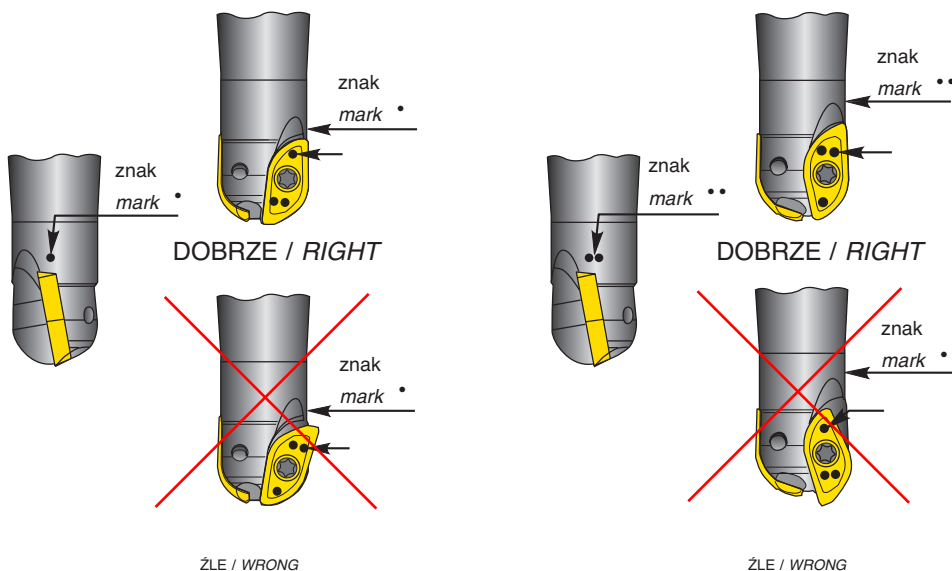

Warunki użytkowania. / Conditions of use.

Typ obróbki / Type of machining

A	B	C	E	F obr. wykańcz. finishing
 <p>$0,1 D_3 \leq a_p < 0,2 D_3$ $a_e \max = 0,15 D_3$</p>	 <p>$0,2 D_3 \leq a_p < 0,4 D_3$ $a_e \max = 0,2 D_3$</p>	 <p>$0,4 D_3 \leq a_p < 0,8 D_3$ $a_e \max = 0,15 D_3$</p>	 <p>$a_p = 0,3 D_3$ $a_e \max = 1 D_3$</p>	 <p>$a_p = 0,3 \div 0,9 \text{ mm}$ $a_e \max = 0,1 \div 0,3 \text{ mm}$</p>

Tabela / Table 1

Parametry skrawania / Cutting data

Materiał / Material	Obr. zgrubna Roughing					Obr. wykańczająca Finishing	
	vc (mm/min)	fz (mm)				vc (mm/min)	fz (mm)
		A	B	C	E		
Stal / Steel HB ≤ 150	230-280	0,4 / 0,36	0,35 / 0,17	0,3 / 0,15	0,2 / 0,1	–	–
Stal / Steel 150 < HB ≤ 200	220-250	0,4 / 0,36	0,35 / 0,17	0,3 / 0,15	0,2 / 0,1	–	–
Stal / Steel 200 < HB ≤ 230	200-220	0,4 / 0,36	0,35 / 0,17	0,25 / 0,20	0,2 / 0,1	–	–
Stal narzędziowa Tool steel 230 < HB ≤ 300	150-200	0,4 / 0,36	0,3 / 0,2	0,2 / 0,1	0,2 / 0,1	400-550	0,1-0,3
Stal hartowana Heat treated steel 300 < HB ≤ 400	110-150	0,4 / 0,36	0,3 / 0,2	0,2 / 0,1	0,2 / 0,1	300-400	0,1-0,3
Stal nierdzewna Stainless steel	90-120	0,4 / 0,36	0,3 / 0,2	0,2 / 0,1	0,2 / 0,1	–	–
Żeliwo / Cast iron HB = 140	180-200	0,5 / 0,4	0,4 / 0,3	0,3 / 0,1	0,3 / 0,1	500-550	0,1-0,3
Stopy aluminium Aluminium alloys	350-400	0,6 / 0,5	0,4 / 0,3	0,3 / 0,1	0,3 / 0,1	850-1000	0,05-0,1
Stopy żaroodporne Tytan Heat resistant alloys Titanium	50-60	0,3 / 0,2	0,2 / 0,1	0,2 / 0,1	0,2 / 0,1	–	–
Stopy żaroodporne Inkonel Heat resistant alloys Inconel	30-40	0,3 / 0,2	0,2 / 0,1	0,2 / 0,1	0,2 / 0,1	–	–

Tabela / Table 2

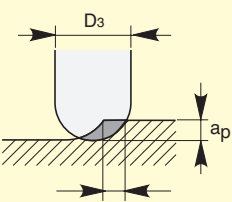
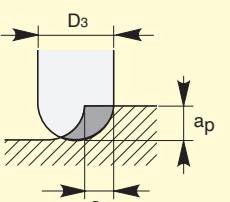
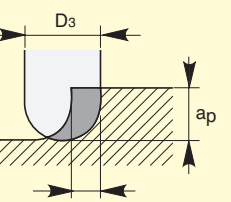
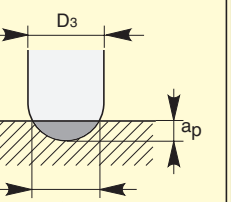
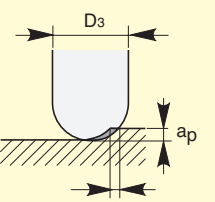
Współczynnik korekcyjny dla v_c i f_z zależny od typu obróbki i średnicy D_3 freza.
Correction factor depending on type of machining and milling cutter diameter.

Typ obr. Type of mach.	Współcz. korekcyjny Correction v_{c1}	D_3						
		↓ 12	↓ 16	↓ 20	↓ 25	↓ 32	↓ 40	↓ 50
A	$v_{c1} = v_c$	$f_{z1} = 0,45 f_z$	$f_{z1} = 0,7 f_z$	$f_{z1} = f_z$	$f_{z1} = f_z$	$f_{z1} = 1,1 f_z$	$f_{z1} = 1,2 f_z$	$f_{z1} = 1,3 f_z$
B	$v_{c1} = v_c$	$f_{z1} = 0,25 f_z$	$f_{z1} = 0,45 f_z$	$f_{z1} = 0,6 f_z$	$f_{z1} = 0,8 f_z$	$f_{z1} = f_z$	$f_{z1} = 1,1 f_z$	$f_{z1} = 1,2 f_z$
C	$v_{c1} = 0,8 v_c$	$f_{z1} = 0,2 f_z$	$f_{z1} = 0,3 f_z$	$f_{z1} = 0,5 f_z$	$f_{z1} = 0,7 f_z$	$f_{z1} = 0,8 f_z$	$f_{z1} = 0,9 f_z$	$f_{z1} = f_z$
E	$v_{c1} = v_c$	$f_{z1} = 0,2 f_z$	$f_{z1} = 0,3 f_z$	$f_{z1} = 0,5 f_z$	$f_{z1} = 0,7 f_z$	$f_{z1} = 0,8 f_z$	$f_{z1} = 0,9 f_z$	$f_{z1} = f_z$
F	$v_{c1} = v_c$	$f_{z1} = f_z$	$f_{z1} = f_z$	$f_{z1} = f_z$	$f_{z1} = f_z$	$f_{z1} = f_z$	–	–

Tabela / Table 3

Współczynnik korekcyjny dla v_c zależny od wysięgu narzędzia l_3 .
Correction for overhang l_3 .

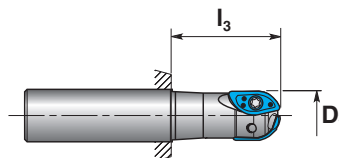

Wysięg narzędzia Tool overhang	$1 D_3 \leq l_3 \leq 2,9 D_3$	$3 D_3 \leq l_3 \leq 3,5 D_3$	$3,6 D_3 \leq l_3 \leq 4 D_3$	$4,1 D_3 \leq l_3 \leq 4,6 D_3$	$4,6 D_3 \leq l_3$
Prędkość skrawania Cutting speed	$v_{c2} = v_{c1}$	$v_{c2} = 0,9 v_{c1}$	$v_{c2} = 0,8 v_{c1}$	$v_{c2} = 0,7 v_{c1}$	$v_{c2} = 0,5 v_{c1}$

Przykład 1 / Example 1

Obróbka zgrubna stali hartowanej o twardości 400HB, wysięgu narzędzia ($l_3 = 110$ mm) i o średnicy freza 32 mm.
Roughing of heat treated steel with 400HB hardness, tool overhang ($l_3 = 110$ mm) with a 32 mm milling cutter.

$a_p = 14$ mm

$a_e = 4$ mm

→ Obróbka typu C / C type machining

Wartość podstawowa Basic value Tabela / Table 1	v_c i f_z korekcja v_c and f_z correction Tabela / Table 2	Korekcja na wysięg Correction for overhang Tabela / Table 3	Wynik Result
$v_c = 1300$ m/min	$v_{c1} = 0,8 \times 130 = 104$ m/min	$v_{c2} = 0,9 \times 104 = 93$ m/min	$v_{c2} = 93$ m/min
$f_z = 0,15$ mm/z	$f_{z1} = 0,8 \times 0,15 = 0,12$ mm/z		$f_{z1} = 0,12$ mm/z

mm/z → z = ząb / tooth

Przykład 2 / Example 2

Obróbka wykańczająca stali hartowanej o twardości 400HB, wysięgu narzędzia ($l_3 = 110$ mm) i o średnicy freza 20 mm.
Finishing of heat treated steel with 400HB hardness, tool overhang ($l_3 = 110$ mm) with a 20 mm milling cutter.

$a_p = 0,5$ mm

$a_e = 0,2$ mm

→ Obróbka typu F / F type machining

Wartość podstawowa Basic value Tabela / Table 1	v_c i f_z korekcja v_c and f_z correction Tabela / Table 2	Korekcja na wysięg Correction for overhang Tabela / Table 3	Wynik Result
$v_c = 350$ m/min	$v_{c1} = 350$ m/min	$v_{c2} = 0,5 \times 350 = 175$ m/min	$v_{c2} = 175$ m/min
$f_z = 0,2$ mm/z	$f_{z1} = 0,2$ mm/z		$f_{z1} = 0,2$ mm/z

mm/z → z = ząb / tooth

3. Porady dla użytkownika / Advice for users

Obróbka ze znacznym wysięgiem narzędzia. / Machining with significant tool overhang.

Aby uniknąć wibracji spowodowanej zwiększonym wysięgiem narzędzia należy zredukować parametry skrawania w granicach 30 - 50 % (patrz tabela 3).

To avoid vibration caused by the bending of long tools, reduce the cutting data by 30 to 50 % (see table 3).

Korekcja tabeli posuwów związana z obrabianym profilem: / Table feed correction according to the profile machined:

W zależności od warunków obróbki należy zmodyfikować tabelę posuwów według poniższego schematu:

Depending on the machining conditions, we advise you to modify the table feed as follows:

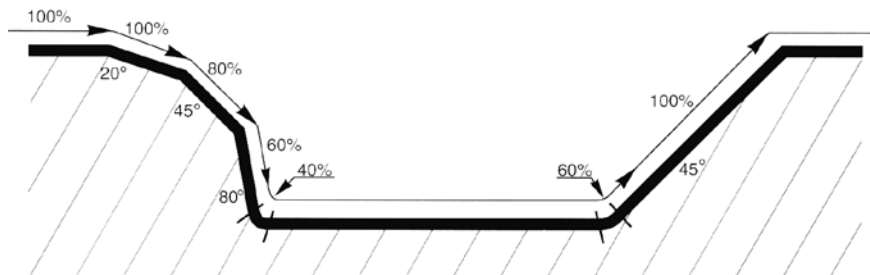

Chropowość powierzchni Rt: / Roughness Rt:

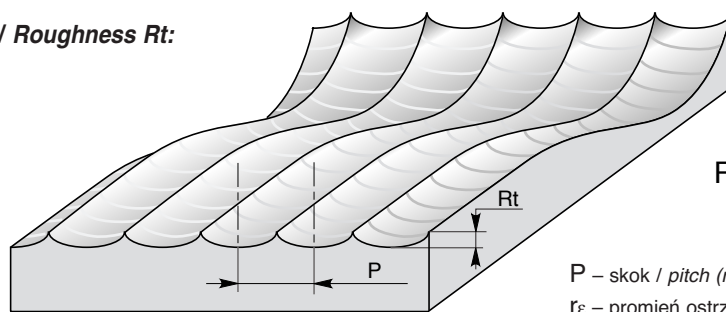

$$Rt = \frac{P^2}{8 r_e}$$

P – skok / pitch (mm)

r_e – promień ostrza płytki / insert edge radius (mm)

Średnica freza D_s Milling cutter diameter D_s	Ø 12			Ø 16			Ø 20			Ø 25			Ø 32			Ø 40			Ø 50		
$P = a_e$	1,0	1,5	2,0	1,0	2,0	3,0	2,0	3,0	4,0	3,0	4,0	5,0	3,0	4,0	5,0	4,0	6,0	8,0	4,0	6,0	8,0
Rt	0,02	0,05	0,08	0,02	0,06	0,14	0,05	0,11	0,20	0,09	0,16	0,25	0,07	0,13	0,20	0,10	0,23	0,40	0,08	0,18	0,32

Wybór średnicy freza. / Choice of diameter.

Wybór odpowiedniej średnicy freza zależy od obrabianego materiału. Stopniowo w trakcie obróbki zgrubnej, średniodokładnej i wykańczającej, średnica używanego freza powinna być stopniowo redukowana. Umożliwia to bardziej dokładne usunięcie materiału w pobliżu naroży oraz chroni przed zniszczeniem ostrze płytki.

This depends on the machining profile to be performed. During successive roughing, semi-finishing and finishing operations on a die, the diameter of the tool used is reduced progressively. The variation in this diameter allows the thickness of the chip to be reduced in the corners and prevents damage to the cutting edges.

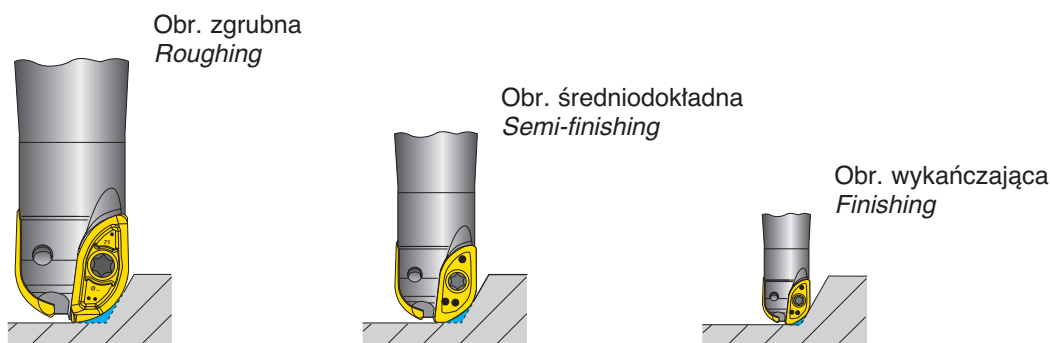

Rzeczywista średnica skrawająca freza. / Actual cutting diameter.

$$D_{ef} = 2 \sqrt{a_p (D_3 - a_p)}$$

$$v_c = \frac{\pi \times D_{ef} \times n}{1000}$$

D_{ef} – rzeczywista średnica skrawająca freza / actual cutting diameter (mm)

D₃ – średnica freza / milling cutter diameter (mm)

v_c – prędkość skrawania / cutting speed (m/min)

a_p – osiowa głębokość skrawania / axial depth of cut (mm)

n – liczba obrotów na minutę (obr/min) / number of revolutions per minute (rev/min)

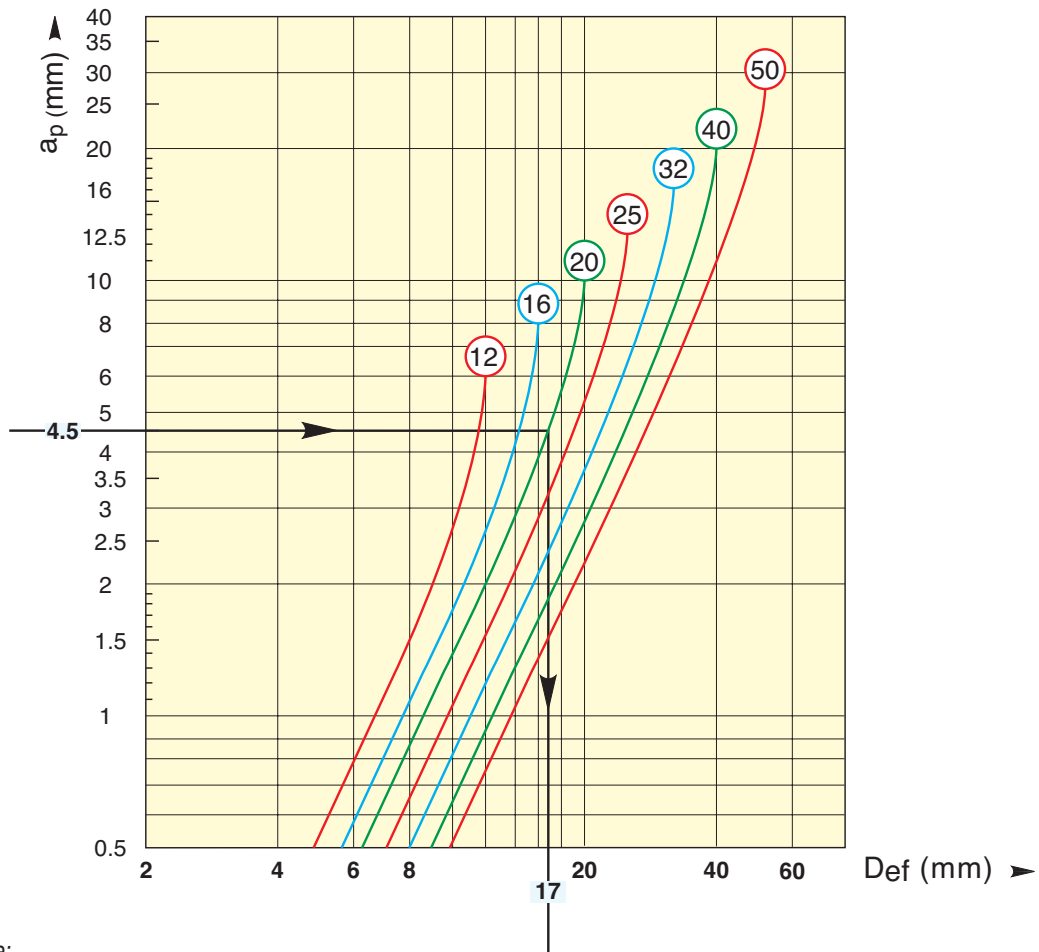
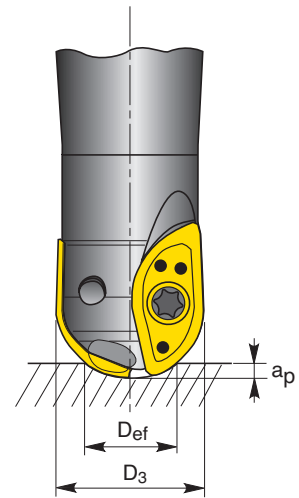

Przykład: / Example:

D₃ = 20 mm, a_p = 4,5 → D_{ef} = 17 mm

Odptyw wióra. / Chip flow.

Podczas obróbki wskazane jest stosowanie strumienia powietrza bezpośrednio na ostrze płytki w celu ułatwienia odpływu wiórów. Nie należy stosować emulsji chłodzącej, gdyż może to spowodować wstrząs termiczny płytki, a w konsekwencji doprowadzić do powstania pęknięć.

We recommend using an air jet directed to the cut to facilitate chip flow. The use of soluble oil for lubrication could cause thermal shocks and subsequent cracks on the cutting edges.

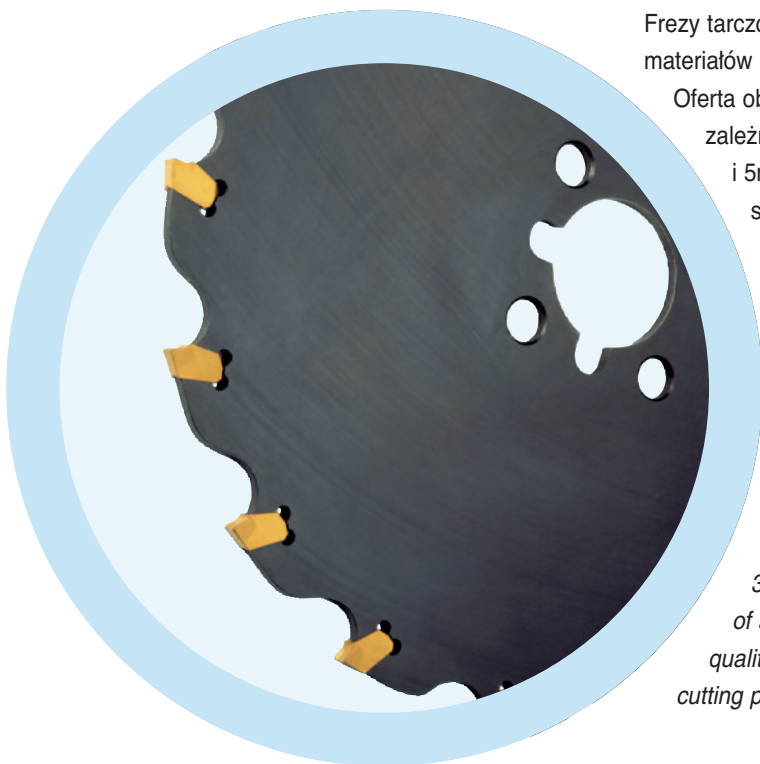

Frezy tarczowe stosowane są do frezowania rowków oraz cięcia materiałów o różnicowanej twardości m.in. stali, staliwa, żeliwa.

Oferta obejmuje frezy o zakresie średnic od 100 do 315 mm i grubości zależnej od stosowanej płytki skrawającej typu LFMX: 3mm, 4mm i 5mm. Nowatorskie rozwiązanie konstrukcyjne gniazd (z zastosowaniem specjalnego stopera) jak i wysoka jakość wykonania, czynią z frezów piłkowych narzędzia wysoce efektywne i podnoszące wydajność obróbki skrawaniem.

Slitting cutters are designed for milling of threads and cutting of materials with varied hardness such as steel, cast steel and cast iron.

The offer includes cutters with diameter thickness ranging from 100 to 315 mm, depending on an LFMX insert used: 3mm, 4mm and 5 mm. Innovative construction solutions of seats (with a special stopper) as well as high performance quality make slitting cutters highly effective and improve cutting productivity.



Tabela / Table 1

a_p / D_c	1/4	1/6	1/8	1/10	1/20
Zwiększenie posuwu: Increase in feed by:	0	15%	30%	45%	100%

Application of NFTs.. slitting cutters

Uwagi praktyczne:

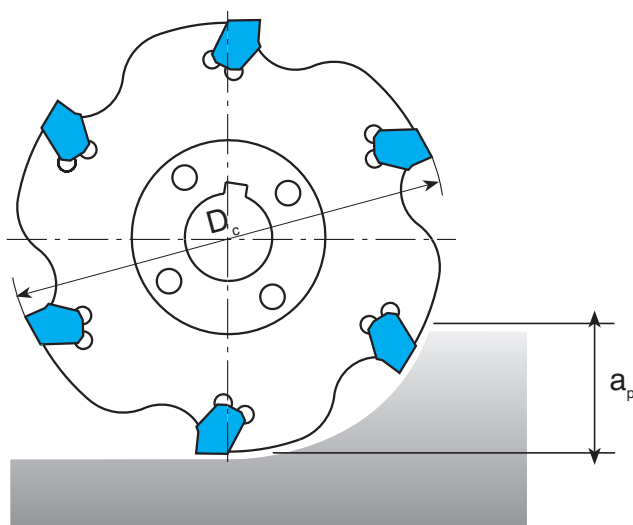
- płytkę należy zamontować w gnieździe przy użyciu plastikowego młotka,
- przez pierwsze 10 - 20 sekund frezować ze zmniejszonym posuwem, następnie zwiększyć posuw do zalecanego,
- zalecane jest frezowanie metodą współbieżną, jednak na obrabiarkach o mniejszej sztywności można stosować frezowanie przeciwbieżne,
- w przypadku frezowania rowków o małych głębokościach należy zwiększyć posuw zgodnie z tabelą (Tabela 1),
- nie wolno przekraczać maksymalnych obrotów podanych na korpusie freza,
- wraz ze zmniejszeniem głębokości skrawania maleje średnia grubość wióra. Celem jej skompensowania należy posłużyć się załączoną Tabelą 1,
- zależność posuwu od szerokości płytki przedstawia Tabela 2.

Practical suggestions:

- inserts should be clamped in a seat by means of a plastic hammer,
- mill with reduced feed for the first 10-20 seconds, then increase the feed to the recommended value,
- down milling is recommended however on less stiff machine tools up milling may be used,
- in case of milling of threads with low depths feed should be increased as per the table. (Table 1),
- maximum number of revolutions marked on the cutter body should not be exceeded,
- along with decreasing cutting depth, average chip thickness goes down. For compensation, use Table 1,
- Table 2 below presents relation between feed and insert width.

Tabela / Table 2

Szerokość płytki a (mm) <i>Insert width</i>	Posuw na ząb fz (mm/z) <i>Feed per tooth fz</i>
3,1	0,03 ÷ 0,16
4,1	0,04 ÷ 0,18
5,1	0,05 ÷ 0,20



Polska PN-	Szwecja SS	Wielka Brytania BS	Niemcy DIN	Czechy		ISO	Nazwa materiału
				W. nr	CSN		
Stale węglowe							
Stal S135	1311	4360 40C	RS137-2	1.0038	12024	E235	Stal konstrukcyjna niestopowa ogólnego przeznaczenia
Stal 20	1450	050A20	C22	1.0402	12024	C20	Stal niestopowa do utwardzania powierzchniowego
Stal 2 C22	1450	050A20	C22	1.0402	12024	C20	Stal niestopowa specjalna do ulepszenia cieplnego
Stal 1 C22	1450	050A20	C22	1.0402	12024	C20	Stal niestopowa jakościowa do ulepszenia cieplnego
Stal A10X	1912	230M07	95Mn28	1.0715	11109	11SMn28	Stal niestopowa automatowa
Stal MS16	1550	060A35	C35	1.0501	11500	Fe490	Stal konstrukcyjna niestopowa ogólnego przeznaczenia
Stal MS16	1650	080M46	C45	1.0503	11600	Fe590	Stal konstrukcyjna niestopowa ogólnego przeznaczenia
Stal A35	1957	212M36	35S20	1.0726	-	35S20	Stal niestopowa automatowa
Stal 45G2	2120	-	36Mn5	1.1167	-	-	Stal konstrukcyjna stopowa do ulepszenia cieplnego i hartowania powierzchniowego
Stal 35	1572	060A35	C35	1.1183	12040	C35	Stal niestopowa do ulepszenia cieplnego
Stal 2 C 35	1572	060A35	C35E	1.1183	12040	C35E4	Stal niestopowa specjalna do ulepszenia cieplnego
Stal 1 C 35	1572	060A35	C35	1.1183	12040	C35	Stal niestopowa jakościowa do ulepszenia cieplnego
Stal 45	1672	080M46	Ck45	1.1191	12060	C45	Stal niestopowa do ulepszenia cieplnego
Stal 55	1655	070M55	C55	1.0535	12060	C55	Stal niestopowa do ulepszenia cieplnego
Stal MS17	1655	070M55	C55	1.0535	11700	C55	Stal konstrukcyjna niestopowa ogólnego przeznaczenia
Stal 2 C 55	1655	070M55	C55	1.0535	12060	C55	Stal niestopowa specjalna do ulepszenia cieplnego
Stal 1 C 55	1655	070M55	C55	1.0535	12060	C55	Stal niestopowa jakościowa do ulepszenia cieplnego
Stal niskostopowa							
Stal R35	1412	4360 43C	S144-2	1.0144	11353	-	Stal określonego zastosowania - na rury
Stal 18G2A	2101	450EM	P500NH	-	422713	-	Stal stopowa o podwyższonej wytrzymałości
Stal 16G2	2132	4360 50B	S152-3	1.0570	11483	E355	Stal niskowęglowa wyższej jakości określonego zastosowania
Stal LH15	2258	534A99	I00C16	1.3505	14109	1	Stal na łożyska toczne
Stal 20M	2912	1501-240	15Mo3	1.5415	15020	F26	Stal stopowa do pracy w podwyższonej temperaturze
Stal 16M	2912	1503-245-420	16Mo5	-	15020	-	Stal stopowa do pracy w podwyższonej temperaturze
Stal 20HNM	2506	805M20	21NiCrMo2	1.6523	-	21NiCrMo2-2	Stal konstrukcyjna stopowa do nawęglania
Stal 22HNM	2506	805M20	21NiCrMo2	1.6523	-	21NiCrMo2-2	Stal konstrukcyjna stopowa do nawęglania
Stal 37HGNM	-	31-1-Type7	-	-	-	-	Stal konstrukcyjna stopowa do ulepszenia cieplnego i hartowania powierzchniowego
Stal 50HG	2253	527A60	55Cr3	-	-	-	Stal stopowa sprężynowa (resorowa)
Stal 15HM	2216	-	15CrMo5	1.7262	15121	14CrMo4-5	Stal stopowa do pracy w podwyższonej temperaturze
Stal 10H2M	2218	1501-622	10CrMo9-10	1.7380	15313	11CrMo9-10	Stal stopowa do pracy w podwyższonej temperaturze
Stal 25H3M	2240	722M24	31CrMo12	1.8515	-	31CrMo12	Stal konstrukcyjna stopowa do azotowania
Stal 17HGN	2512	823M30	56NiCrMoV6G	1.7228	16121	-	Stal konstrukcyjna stopowa do nawęglania
Stal 16HG	2127	-	16MnCr5	1.7139	14220	16MnCr5	Stal konstrukcyjna stopowa do nawęglania
Stal 20HG	2127	-	20MnCr5	1.7139	14221	18CrMo4	Stal konstrukcyjna stopowa do nawęglania
Stal 50S2	2090	-	55S17	1.0904	13251	-	Stal stopowa sprężynowa (resorowa)
Stal 55S2	2090	-	55S17	1.0904	13270	-	Stal stopowa sprężynowa (resorowa)
Stal 36HNM	-	816M40	36CrNiMo4	-	-	36CrNiMo4	Stal konstrukcyjna stopowa do ulepszenia cieplnego
Stal 38HNM	-	817M40	36CrNiMo4	-	-	36CrNiMo4	Stal konstrukcyjna stopowa do ulepszenia cieplnego i hartowania powierzchniowego
Stal 34HNM	2541	530A32	35CrNiMo6	1.5682	16343	36CrNiMo6	Stal konstrukcyjna stopowa do ulepszenia cieplnego
Stal 30H	2244	530A32	34Cr4	1.7223	14331	34Cr4	Stal konstrukcyjna stopowa do ulepszenia cieplnego
Stal 40H	2244	530A40	41Cr4	1.7218	14140	41Cr4	Stal konstrukcyjna stopowa do ulepszenia cieplnego i hartowania powierzchniowego
Stal 20HM	2225	1717CDS110	25CrMo4	1.7218	-	F31	Stal stopowa do pracy w podwyższonej temperaturze
Stal 30HM	2225	1717CDS110	25CrMo4	1.7218	-	F31	Stal stopowa do pracy w podwyższonej temperaturze
Stal 25HM	2225	1717CDS110	25CrMo4	1.7218	-	F31	Stal stopowa do pracy w podwyższonej temperaturze
Stal 35HM	2234	708A37	34CrMo4	1.7220	15142	-	Stal stopowa do pracy w podwyższonej temperaturze
Stal 40HM	2244	708M40	42CrMo4	1.7223	15142	-	Stal konstrukcyjna stopowa do ulepszenia cieplnego i hartowania powierzchniowego
Stal 50HF	2230	735A50	51CrV4	1.8159	15260	-	Stal konstrukcyjna stopowa do ulepszenia cieplnego i hartowania powierzchniowego
Stal 38HMJ	2940	905M39	41CrAlNiMo7	1.8509	15340	-	Stal stopowa sprężynowa (resorowa)
Stal NC4	-	BL3	100Cr6	-	-	100Cr2	Stal konstrukcyjna stopowa do azotowania
Stal NWC	2140	-	105WCr6	1.2419	-	105WCr1	Stal narzędziowa stopowa do pracy na zimno
Stal WNLV	-	BH224/5	56NiCrMoV7	-	19663	55NiCrMoV2	Stal narzędziowa stopowa do pracy na zimno
Stal wysokostopowa							
Stal NC11	-	BD3	X210Cr12	-	19436	210Cr12	Stal narzędziowa stopowa do pracy na zimno
Stal WCLV	2242	BH13	X40CrMoV5.1	1.2344	19554	40CrMoV5	Stal narzędziowa stopowa do pracy na gorąco
Stal NCLV	2260	BA2	X100CrMoV5.1	1.2363	-	100CrMoV5	Stal narzędziowa stopowa do pracy na zimno
Stal NZ2	2710	BS1	45WCrV7	1.2542	19732	45WCrV2	Stal narzędziowa stopowa do pracy na zimno
Stal WVV	-	BH21	X30WCrV9	-	19721	30WCrV9	Stal narzędziowa stopowa do pracy na zimno
Stal NC11LV	2310	BD2	X165CrMoV12	1.2601	19572	160CrMoV12	Stal narzędziowa stopowa do pracy na gorąco
Stal H9S2	-	4959BA2	X45CrSi93	-	17115	401S45	Stal zaworowa
Stal SW2M5	2715	BM2	S6-5-2	1.3343	19830	HS 6-5-2	Stal szybkozmaca
Stal SW7M	2722	BM2	S6-5-2	1.3343	19830	HS 6-5-2	Stal szybkozmaca
Stal SK5M	2723	BM35	S6-5-2-5	1.3243	19852	HS 6-5-2-5	Stal szybkozmaca

Polska PN-	Szwecja SS	Wielka Brytania BS	Niemcy DIN	Czechy		ISO	Nazwa materiału
				W. nr	CSN		
Staliwa							
L45G	-	-	-	-	-	-	Stalowo niskostopowe odporne na ścieranie
L35GSM	-	-	-	-	-	-	Stalowo niskostopowe odporne na ścieranie
L120G13	-	-	-	-	-	-	Stalowo wysokostopowe odporne na ścieranie
L150HSM	2183	BW10	G20Mn5	1.3401	-	C26-52	Stalowo wysokostopowe odporne na ścieranie
L20G	-	A1	G30Mn5	-	13240	-	Stalowo niskostopowe konstrukcyjne
L30GS	-	A5	-	-	-	-	Stalowo niskostopowe konstrukcyjne
L40H	-	-	-	-	-	-	Stalowo niskostopowe konstrukcyjne
L35GN	-	-	-	-	-	-	Stalowo niskostopowe konstrukcyjne
Stale nierdzewne o strukturze ferrytyczno-martensytcznej							
Stal 0H13	2301	403S17	X7Cr13	1.4000	17020	-	Stal odporna na korozję
Stal H17	2320	430S15	X8Cr17	1.4016	17041	8	Stal odporna na korozję
Stal H17	2320	430S17	X8Cr17	1.4016	17041	8	Stal odporna na korozję
Stal 1H13	2302	410S21	X10Cr13	1.4006	17021	-	Stal odporna na korozję
Stal 3H13	2304	420S45	X46Cr13	1.4034	17023	-	Stal odporna na korozję
Stal 20H12M1F	2317	-	X20CrMoV12-1	1.4922	422916	F40	Stal stopowa do pracy w podwyższonej temperaturze
Stal 23H12MNF	2317	-	X22CrMoV12-1	1.4922	17.134	F40	Stal stopowa do pracy w podwyższonej temperaturze
Stal nierdzewne o strukturze austenitycznej							
Stal 00H18N10	2352	304S11	-	1.4306	17.249	10	Stal odporna na korozję
Stal 0H18N9	2332/2333	304S31	X5CrNi189	1.4350	17.240	11	Stal odporna na korozję
Stal 1H18N9	2331	302S25	X12CrNi17 7	1.4310	17.242	14	Stal odporna na korozję
Stal 00H17N14M2	2348	316S13	X2CrNiMo 18-10	1.4404	17.349	19a	Stal odporna na korozję
Stal H18S	2348	316S13	X2CrNiMo 18-12	1.4404	17.349	19a	Stal żaroodporna
Stal 0H18N10T	2337	321S12	X10CrNiTi18 9	1.4541	17.248	15	Stal odporna na korozję
Stal 1H18N9T	2337	321S12	X10CrNiTi18 9	1.4541	17.246	15	Stal odporna na korozję
Stal 0H18N12Nb	2338	347S17	X10CrNiNb18 9	1.4550	-	-	Stal odporna na korozję
Stal 0H18N10MT	2350	320S17	X10CrNiMoTi18 10	1.4571	17.348	21	Stal odporna na korozję
Stal H17N13M2T	2350	320S17	X10CrNiMoNb18 12	1.4571	17.348	21	Stal odporna na korozję
Żeliza ciągliwe							
Żelievo B 35-10	815	B 340/12	GTS-35	-	422.533	B 35-10	Żelievo ciągliwe
Żelievo W 40-05	-	-	GJMW-400-05	-	422.440	W 40-05	Żelievo ciągliwe
Żelievo W 45-07	-	-	GJMW-450-7	-	422.545	W 45-07	Żelievo ciągliwe
Żelievo W 35-04	-	-	GTW 35-04	-	422.536	W 35-04	Żelievo ciągliwe
Żelievo B 32-12	-	-	-	-	422.533	B 32-12	Żelievo ciągliwe
Żelievo P45-06	-	-	GTS-45-06	-	-	P 45-06	Żelievo ciągliwe
Żelievo P50-05	-	-	GJMB-500-05	-	422.550	P 50-05	Żelievo ciągliwe
Żeliza szare							
Żelievo 100	110	-	GG 10	-	422.410	100	Żelievo szare
Żelievo 150	115	Grade 150	GG 15	-	422.415	150	Żelievo szare
Żelievo 200	120	Grade 200	GG 20	-	422.420	200	Żelievo szare
Żelievo 250	125	Grade 260	GG 25	-	422.425	250	Żelievo szare
Żelievo 300	130	Grade 300	GG 30	-	422.430	300	Żelievo szare
Żelievo 350	135	Grade 350	GG 35	-	422.435	350	Żelievo szare
Żeliza sferoidalne							
Żelievo 400-15	0717-00	SNG 420/12	GGG 40	-	424.304	400-12	Żelievo sferoidalne
Żelievo 500-7	0727-02	SNG 500/7	GGG 50	0.7040	-	500-7	Żelievo sferoidalne
Żelievo 600-3	0732-03	SNG 600/3	GGG 60	0.7050	422.306	600-2	Żelievo sferoidalne
Żelievo 700-2	0737-01	SNG 700/2	GGG 70	0.7070	-	700-2	Żelievo sferoidalne
Stop aluminium							
Stop aluminium AISI7Mg	4244	LM 25	-	-	SG70N	AISI7MgFe	Odlewiczny stop aluminium
Stop aluminium AISI11	4261	LM6	G-AISI12	-	SI2N	AISI12	Odlewiczny stop aluminium



Rodzaje zużycia ostrza

Tooth wear

Starcie na powierzchni przyłożenia Flank wear



Zużycie – szybkie starcie na powierzchni przyłożenia, powodujące niską jakość powierzchni obrabianej oraz niezgodności wymiarowe detalu.

Przyczyna – zbyt duża prędkość skrawania lub za niska odporność na ścieranie.

Środki zaradcze – wybrać gatunek o większej odporności na ścieranie. Dla materiałów mających skłonność do utwardzania się w czasie obróbki, należy zastosować mniejszy kąt przystawienia. Zmniejszyć prędkość skrawania przy obróbce materiałów żaroodpornych.

Tool wear – rapid flank wear causing poor surface texture or inconsistency in tolerance.

Cause – cutting speed too high or insufficient wear resistance.

Remedy – select a more wear resistant grade. For work-hardening materials, select a smaller entering angle. Reduce cutting speed when machining heat resistant material.

Krater na powierzchni natarcia Crater wear



Zużycie – nadmierne zużycie w formie krateru, powodujące osłabienie krawędzi skrawającej oraz niską jakość powierzchni obrabianej.

Przyczyna – zbyt duża temperatura wydzielająca się w czasie obróbki oraz zbyt duże naciski na powierzchnię natarcia płytki.

Środki zaradcze – najpierw zmniejszyć prędkość skrawania aby obniżyć temperaturę, w drugiej kolejności zmniejszyć posuw. Wybrać bardziej odporny na ścieranie gatunek.

Tool wear – excessive crater wear causing a weakened edge and poor surface finish.

Cause – excessive cutting temperatures and pressure on the top face of inserts.

Remedy – first, reduce cutting speed to obtain a lower temperature and secondly, the feed. Select a more wear resistant grade.

Odształcenie plastyczne Plastic deformation



Zużycie – odształcenie plastyczne krawędzi skrawającej, obniżenie lub odcisk na powierzchni przyłożenia, prowadzące do złych warunków tamania i odprowadzania wióra, niskiej jakości powierzchni obrabianej oraz złamania płytki.

Przyczyna – zbyt duża temperatura skrawania oraz nacisk na powierzchnię natarcia płytki.

Środki zaradcze – zastosować twardszy gatunek o większej odporności na ścieranie. Zmniejszyć prędkość skrawania. Zmniejszyć posuw.

Tool wear – plastic deformation of edge, depression or flank impression, leading to poor chip control poor surface finish and insert breakage.

Cause – cutting temperature and pressure too high.

Remedy – select a more wear resistant grade, which is harder. Reduce cutting speed. Reduce feed.

Narost Built-up edge



Zużycie – zgranie wióra do powierzchni przyłożenia i wyrwanie fragmentu krawędzi skrawającej, powodujące niską jakość powierzchni obrabianej.

Przyczyna – zbyt niska temperatura w strefie skrawania. Ujemna geometria płytki. Ciągły, klejący się do ostrza płytki materiał np. stal niskowęglowa, nierdzewna lub aluminium.

Środki zaradcze – zwiększyć prędkość skrawania. Wybrać płytkę o dodatniej geometrii.

Tool wear – built-up edge causing poor surface finish and cutting edge chipping, when the BUE is torn away.

Cause – cutting zone temperature is too low. Negative cutting geometry. Very sticky material, such as low-carbon steel, stainless steels and aluminium.

Remedy – increase cutting speed. Select a positive geometry insert.

OZNAKI NADMIERNEGO ZUŻYCIA: INDICATIONS OF EXCESSIVE TOOL WEAR:

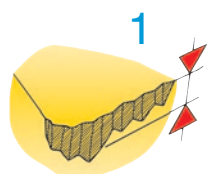

Zużycie narzędzi.
Tool wear.



Wzrost poboru mocy przez obrabiarkę.
Rise in machine power.

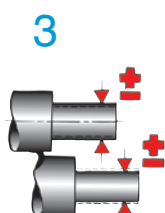

Wymiary przedmiotu nie mieszczą się w wymaganych tolerancjach.
Component out of tolerance.

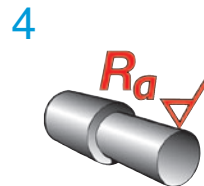

Niska jakość.
Poor surface finish.

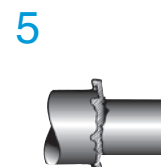

Powstawanie zadziórów na detalu.
Burr formation on component.

Rodzaje zużycia ostrza

Tooth wear

Pęknięcia cieplne Thermal cracks



Zużycie – małe pęknięcia prostopadłe do krawędzi skrawającej, powodujące łuszczenie oraz niską jakość powierzchni obrabianej.

Przyczyna – zbyt duże zmiany temperatury. Obróbka przerywana. Nierównomierne dostarczanie chłodziwa.

Środki zaradcze – wybrać gatunek o większej udarności. Chłodziwo powinno być podawane obficie lub w ogóle.

Tool wear – small cracks perpendicular to the cutting edge causing chipping and poor surface finish.

Cause – excessive temperature variations. Intermittent machining. Varying coolant supply.

Remedy – select a tougher insert grade. Coolant should be applied copiously or not at all.

Wykruszenia Chipping



Zużycie – małe wykruszenia na krawędzi skrawającej, prowadzące do niskiej jakości powierzchni obrabianej oraz nadmiernego starcia na powierzchni przyłożenia.

Przyczyna – zbyt krucha krawędź skrawająca. Za słaba krawędź płytki. Utworzył się narost.

Środki zaradcze – wybrać gatunek o większej udarności. Wybrać płytkę o mocniejszej krawędzi skrawania. Zmniejszyć prędkość skrawania.

Tool wear – small cutting edge chipping leading to poor surface texture and excessive flank wear.

Cause – cutting edge too brittle. Insert edge too weak. Built-up edge has been formed.

Remedy – select tougher grade. Select an insert with a stronger cutting edge. Decrease cutting speed.

Złamanie krawędzi Edge fracture



Zużycie – zniszczeniu może ulec nie tylko płytka, ale również podkładka i przedmiot obrabiany.

Przyczyna – zbyt kruchy gatunek węglik. Za duże obciążenia płytki. Za duży kąt przyłożenia płytki. Za mały rozmiar płytki.

Środki zaradcze – wybrać bardziej ciągliwy gatunek węglik. Zmniejszyć posuw i/lub głębokość skrawania. Wybrać płytkę o mniejszym kącie przyłożenia i/lub natarcia, najlepiej płytkę jednostronną. Zwiększyć stabilność układu OUPN.

Tool wear – damages not only the insert but can also ruin the shim and workpiece.

Cause – too brittle carbide grade. Excessive load on the insert. Too high clearance. Too small insert.

Remedy – reduce feed and/or depth of cut. Select a stronger geometry, preferably a single sided insert. Select a thicker/larger insert and tougher grade. Improve stability.

Powstanie karbów Notch wear



Zużycie – karby powodują niską jakość powierzchni obrabianej oraz ryzyko złamania krawędzi.

Przyczyna – za duża prędkość skrawania lub niedostateczna odporność na ścieranie

Środki zaradcze – wybrać gatunek o większej odporności na ścieranie. Dla materiałów mających skłonność do utwardzania się podczas obróbki, należy zastosować mniejszy kąt przystawienia. Podczas obróbki materiałów żaroodpornych należy zmniejszyć prędkość skrawania.

Tool wear – notch wear causing poor surface texture and risk of edge breakage.

Cause – cutting speed too high or insufficient wear resistance.

Remedy – select a more wear resistant grade. For work-hardening materials, select a smaller entering angle. Reduce cutting speed when machining heat resistant material.

6

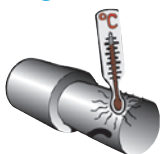

Wydzielająca się nadmierna ilość ciepła.
Excessive heat generated.

7



Wykruszenia krawędzi skrawającej.
Insert chippings found.

8

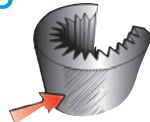

Słabe odprowadzanie ciepła w czasie obróbki.
Poor heat distribution during machining.

9



Złe warunki łamania i odprowadzania wiórów.
Poor chip control.



Duży hałas podczas obróbki.
Excessive noise during machining.

11

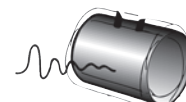

Tendencja do drgań.
Vibration tendency.





Twój dystrybutor:

CENTRALA TECHNICZNA
ELTECH ®

Centrala Techniczna ELTECH Sp. z o.o.
ul. Fabryczna 1-3, 58-100 Świdnica

tel. 74 858 27 00 fax 74 858 27 01

eltech@eltech.com.pl www.eltech.com.pl



SANDVIK

SANDVIK POLSKA Sp. z o.o.
Al. Wilanowska 372, 02-665 Warszawa
tel. +48 (22) 647 38 80, fax +48 (22) 334 69 91
www.sandvik.com/pl, www.balidonit.pl